



The Synchronization Experts.



## TECHNICAL REFERENCE

**microSync**

**RX800/AD10DC20**

December 1, 2023

Meinberg Funkuhren GmbH & Co. KG



# Table of Contents

<b>1</b>	<b>Imprint</b>	<b>1</b>
<b>2</b>	<b>Copyright and Liability Exclusion</b>	<b>2</b>
<b>3</b>	<b>Presentation Conventions in this Manual</b>	<b>3</b>
3.1	Conventions for the Presentation of Critical Safety Warnings . . . . .	3
3.2	Secondary Symbols Used in Safety Warnings . . . . .	4
3.3	Conventions for the Presentation of Other Important Information . . . . .	4
3.4	Generally Applicable Symbols . . . . .	5
<b>4</b>	<b>Important Safety Information</b>	<b>6</b>
4.1	Appropriate Usage . . . . .	6
4.2	Product Documentation . . . . .	7
4.3	Safety during Installation . . . . .	8
4.4	Connection of Protective Earth Conductor/Grounding . . . . .	9
4.5	Electrical Safety . . . . .	10
4.5.1	Special Information for Devices with AC Power Supply . . . . .	12
4.5.2	Special Information for Devices with DC Power Supply . . . . .	12
4.6	Safety when Handling SFP Modules . . . . .	12
4.7	Safety when Maintaining and Cleaning the Device . . . . .	13
4.8	Battery Safety . . . . .	13
<b>5</b>	<b>Important Product Information</b>	<b>14</b>
5.1	CE Marking . . . . .	14
5.2	UKCA Marking . . . . .	14
5.3	Ensuring the Optimum Operation of Your Device . . . . .	14
5.4	Maintenance and Modifications . . . . .	15
5.4.1	Replacing the Battery . . . . .	15
5.5	Prevention of ESD Damage . . . . .	16
5.6	Disposal . . . . .	17
<b>6</b>	<b>microSync Introduction</b>	<b>18</b>
<b>7</b>	<b>microSync RX800/AD10DC20 Connectors</b>	<b>19</b>
7.1	AC/DC Power Supply . . . . .	19
7.2	microSync OLED Display . . . . .	23
7.3	GNSS Antenna . . . . .	25
7.4	LTC/GPIO . . . . .	26
7.5	Programmable Pulse Output . . . . .	26
7.6	Status LEDs - VSG Signals . . . . .	27
7.7	DARS Output . . . . .	28
7.8	Word Clock Output . . . . .	28
7.9	Blackburst Input . . . . .	29
7.10	Blackburst Output . . . . .	29
7.11	Status LEDs - input signals . . . . .	30
7.12	Pulse Per Second Input . . . . .	31
7.13	Word Clock Input . . . . .	31
7.14	LAN Network Interfaces . . . . .	31
7.15	USB Interface . . . . .	32
7.16	Status Indicators - CPU and Receiver . . . . .	33
7.17	RS-232 COMx Timestring . . . . .	34

<b>8</b>	<b>Information on Satellite Reception</b>	<b>35</b>
8.1	Multi GNSS Satellite Receiver . . . . .	35
8.2	How Satellite Navigation Works . . . . .	35
8.2.1	Time Zones and Daylight Saving Time . . . . .	36
<b>9</b>	<b>GNSS Antenna Installation</b>	<b>37</b>
9.1	Installation of the Multi-GNSS Antenna . . . . .	38
9.2	Technical Specifications: RV-76G GPS/GLONASS Antenna for Mobile Applications . . . . .	43
<b>10</b>	<b>Starting of Operation</b>	<b>44</b>
10.1	Initial Network Configuration . . . . .	44
10.1.1	Network Configuration via Serial Connection . . . . .	45
10.1.2	Network Configuration via Web Interface . . . . .	47
10.1.3	Network Configuration via Meinberg Device Manager . . . . .	49
10.2	Initial Start of Operation . . . . .	52
10.2.1	Start of Operation with meinbergOS Web Interface . . . . .	52
10.2.2	Start of Operation with Meinberg Device Manager Software . . . . .	53
<b>11</b>	<b>Technical Appendix</b>	<b>55</b>
11.1	Technical Specifications microSync Chassis . . . . .	55
11.2	Technical Specifications GNSS Receiver . . . . .	56
11.3	Configuration Options . . . . .	58
11.4	Protocols and Profiles . . . . .	58
11.5	Compliances . . . . .	58
<b>12</b>	<b>Technical Appendix: GNSS Antennas + Accessories</b>	<b>59</b>
12.1	Technical Specifications: 40 dB Multi GNSS Antenna . . . . .	59
12.2	Technical Specifications: Antenna Cable . . . . .	60
12.3	Technical Specifications: MBG-S-PRO Surge Protector . . . . .	61
12.3.1	MBG S-PRO: Physical Dimensions . . . . .	63
12.3.2	Installation and Grounding . . . . .	63
12.4	Technical Specifications: RV-76G GPS/GLONASS Antenna for Mobile Applications . . . . .	64
<b>13</b>	<b>RoHS Conformity</b>	<b>66</b>
<b>14</b>	<b>Declaration of Conformity for Operation in the European Union</b>	<b>67</b>
<b>15</b>	<b>Declaration of Conformity for Operation in the United Kingdom</b>	<b>68</b>

# 1 Imprint

**Meinberg Funkuhren GmbH & Co. KG**  
Lange Wand 9, 31812 Bad Pyrmont, Germany

Phone: + 49 (0) 52 81 / 93 09 - 0  
Fax: + 49 (0) 52 81 / 93 09 - 230

Website: <https://www.meinbergglobal.com>  
Email: [info@meinberg.de](mailto:info@meinberg.de)

Date: December 1, 2023

Manual  
Version: 1.04

## 2 Copyright and Liability Exclusion

Except where otherwise stated, the contents of this document, including text and images of all types and translations thereof, are the intellectual property and copyright of Meinberg Funkuhren GmbH & Co. KG ("Meinberg" in the following) and are subject to German copyright law. All reproduction, dissemination, modification, or exploitation is prohibited unless express consent to this effect is provided in writing by Meinberg. The provisions of copyright law apply accordingly.

Any third-party content in this document has been included in accordance with the rights and with the consent of its copyright owners.

A non-exclusive license is granted to redistribute this document (for example, on a website offering free-of-charge access to an archive of product manuals), provided that the document is only distributed in its entirety, that it is not modified in any way, that no fee is demanded for access to it, and that this notice is left in its complete and unchanged form.

At the time of writing of this document, reasonable effort was made to carefully review links to third-party websites to ensure that they were compliant with the laws of the Federal Republic of Germany and relevant to the subject matter of the document. Meinberg accepts no liability for the content of websites not created or maintained by Meinberg, and does not warrant that the content of such external websites is suitable or correct for any given purpose.

While Meinberg makes every effort to ensure that this document is complete, suitable for purpose, and free of material errors or omissions, and periodically reviews its library of manuals to reflect developments and changing standards, Meinberg does not warrant that this specific document is up-to-date, comprehensive, or free of errors. Updated manuals are provided at [www.meinbergglobal.com](http://www.meinbergglobal.com) and [www.meinbergsupport.com](http://www.meinbergsupport.com).

You may also write to [techsupport@meinberg.de](mailto:techsupport@meinberg.de) to request an updated version at any time or provide feedback on errors or suggested improvements, which we are grateful to receive.

Meinberg reserves the right to make changes of any type to this document at any time as is necessary for the purpose of improving its products and services and ensuring compliance with applicable standards, laws & regulations.

## 3 Presentation Conventions in this Manual

### 3.1 Conventions for the Presentation of Critical Safety Warnings

Warnings are indicated with the following warning boxes, using the following signal words, colors, and symbols:



#### Caution!

This signal word indicates a hazard with a **low risk level**. Such a notice refers to a procedure or other action that may result in **minor injury** if not observed or if improperly performed.



#### Warning!

This signal word indicates a hazard with a **medium risk level**. Such a notice refers to a procedure or other action that may result in **serious injury or even death** if not observed or if improperly performed.



#### Danger!

This signal word indicates a hazard with a **high risk level**. Such a notice refers to a procedure or other action that will very likely result in **serious injury or even death** if not observed or if improperly performed.

## 3.2 Secondary Symbols Used in Safety Warnings

Some warning boxes may feature a secondary symbol that emphasizes the defining nature of a hazard or risk.



The presence of an "electrical hazard" symbol is indicative of a risk of electric shock or lightning strike.



The presence of a "fall hazard" symbol is indicative of a risk of falling when performing work at height.



This "laser hazard" symbol is indicative of a risk relating to laser radiation.

## 3.3 Conventions for the Presentation of Other Important Information

Beyond the above safety-related warning boxes, the following warning and information boxes are also used to indicate risks of product damage, data loss, and information security breaches, and also to provide general information for the sake of clarity, convenience, and optimum operation:



### Important!

Warnings of risks of product damage, data loss, and also information security risks are indicated with this type of warning box.



### Information:

Additional information that may be relevant for improving efficiency or avoiding confusion or misunderstandings is provided in this form.



### 3.4 Generally Applicable Symbols

The following symbols and pictograms are also used in a broader context in this manual and on the product.



The presence of the "ESD" symbol is indicative of a risk of product damage caused by electrostatic discharge.



Direct Current (DC) (*symbol definition IEC 60417-5031*)



Alternating Current (AC) (*symbol definition IEC 60417-5032*)



Ground Connection (*symbol definition IEC 60417-5017*)



Protective Earth Connection (*symbol definition IEC 60417-5019*)



Disconnect All Power Connectors (*symbol definition IEC 60417-6172*)

## 4 Important Safety Information



The safety information provided in this chapter as well as specific safety warnings provided at relevant points in this manual must be observed during every installation, set-up, and operation procedure of the device, as well as its removal from service.

Any safety warnings affixed to the device itself must also be observed.

Any failure to observe this safety information, these safety warnings, and other safety-critical operating instructions in the product documentation, or any other improper usage of the device may result in unpredictable behavior from the product, and may result in injury or death.

Depending on your specific device configuration and installed options, some safety information may not be applicable to your device.

Meinberg accepts no responsibility for injury or death arising from a failure to observe the safety information, warnings, and safety-critical instructions provided in the product documentation.

It is the responsibility of the operator to ensure that the product is safely and properly used.

Should you require additional assistance or advice on safety-related matters for your product, Meinberg's Technical Support team will be happy to assist you at any time. Simply send a mail to [techsupport@meinberg.de](mailto:techsupport@meinberg.de).

### 4.1 Appropriate Usage



**The device must only be used appropriately in accordance with the specifications of the product documentation!** Appropriate usage is defined exclusively by this manual as well as any other relevant documentation provided directly by Meinberg.

**Appropriate usage includes in particular compliance with specified limits!** The device's operating parameters must never exceed or fall below these limits!

## 4.2 Product Documentation

The information in this manual is intended for readers with an appropriate degree of safety awareness.

The following are deemed to possess such an appropriate degree of safety awareness:

- **skilled persons** with a familiarity with relevant national safety standards and regulations,
- **instructed persons** having received suitable instruction from a skilled person on relevant national safety standards and regulations



Read the product manual carefully and completely before you set the product up for use.

If any of the safety information in the product documentation is unclear for you, do **not** continue with the set-up or operation of the device!

Safety standards and regulations change on a regular basis and Meinberg updates the corresponding safety information and warnings to reflect these changes. It is therefore recommended to regularly visit the Meinberg website at <https://www.meinbergglobal.com> or the Meinberg Customer Portal at <https://meinberg.support> to download up-to-date manuals.

Please keep all product documentation, including this manual, in a safe place in a digital or printed format to ensure that it is always easily accessible.

Meinberg's Technical Support team is also always available at [techsupport@meinberg.de](mailto:techsupport@meinberg.de) if you require additional assistance or advice on safety aspects of your system.

## 4.3 Safety during Installation

This rack-mounted device has been designed and tested in accordance with the requirements of the standard IEC 62368-1 (*Audio/Video, Information and Communication Technology Equipment—Part 1: Safety Requirements*). Where the rack-mounted device is to be installed in a larger unit (such as an electrical enclosure), additional requirements in the IEC 62368-1 standard may apply that must be observed and complied with. General requirements regarding the safety of electrical equipment (such as IEC, VDE, DIN, ANSI) and applicable national standards must be observed in particular.

The device has been developed for use in industrial or commercial environments and may only be used in such environments. In environments at risk of high environmental conductivity ("high pollution degree" according to IEC 60664-1), additional measures such as installation of the device in an air-conditioned electrical cabinet may be necessary.



If the unit has been brought into the usage area from a cold environment, condensation may develop; in this case, wait until the unit has adjusted to the temperature and is completely dry before setting it up.

When unpacking & setting up the equipment, and before operating it, be sure to read the information on installing the hardware and the specifications of the device. These include in particular dimensions, electrical characteristics, and necessary environmental conditions.

Fire safety standards must be upheld with the device in its installed state.

The device with the highest mass should be installed at the lowest position in the rack in order to position the center of gravity of the rack as a whole as low as possible and minimize the risk of the rack tipping over. Further devices should be installed from the bottom, working your way up.

The device must be protected against mechanical & physical stresses such as vibration or shock.

**Never** drill holes into the device to mount it! If you are experiencing difficulties with rack installation, contact Meinberg's Technical Support team for assistance!

Inspect the device housing before installation. The device housing must be free of any damage when it is installed.

## 4.4 Connection of Protective Earth Conductor/Grounding

In order to ensure that the device can be operated safely and to meet the requirements of IEC 62368-1, the device must be correctly connected to the protective earth conductor via the protective earth connection terminal.

If an external ground connection is provided on the housing, it must be connected to the grounding busbar (earthing busbar) for safety reasons before connecting the power supply. Like this, any possible leakage current on the housing is safely discharged to earth.



The screw, washer and toothed lock washer necessary for mounting the grounding cable are located at the grounding point of the housing. A grounding cable is not included in the contents of delivery.

**Note:** Please use a grounding cable with cross-section  $\geq 1.5 \text{ mm}^2$ , as well as a suitable grounding clamp/lug. Always ensure that the connection is properly crimped!

## 4.5 Electrical Safety

**This Meinberg product is operated at a hazardous voltage.**

This system may only be set up and connected by a skilled person, or by an instructed person who has received appropriate technical & safety training from a skilled person.

Custom cables may only be assembled by a qualified electrician.

**Never** work on cables carrying a live current!

**Never** use cables or connectors that are visibly damaged or known to be defective! Faulty, defective, or improperly connected shielding, connectors, or cables present a risk of injury or death due to electric shock and may also constitute a fire hazard!

Before operating the device, check that all cables are in good order. Ensure in particular that the cables are undamaged (for example, kinks), that they are not wound too tightly around corners, and that no objects are placed on the cables.

Cables must be laid in such a way that they do not present a tripping hazard.

The power supply should be connected using a short, low-inductance cable. Avoid the use of power strips or extension cables if possible. If the use of such a device is unavoidable, ensure that it is expressly rated for the rated currents of all connected devices.

**Never** connect or disconnect power, data, or signal cables during a thunderstorm! Doing so presents a risk of injury or death, as cables and connectors may conduct very high voltages in the event of a lightning strike!

Device cables must be connected or disconnected in the order specified in the user documentation for the device. Connect all cables only while the device is de-energized before you connect the power supply.

**Always** pull cable connectors out at **both** ends before performing work on connectors! Improperly connecting or disconnecting this Meinberg system may result in electric shock, possibly resulting in injury or death!

When pulling out a connector, **never** pull on the cable itself! Pulling on the cable may cause the plug to become detached from the connector or cause damage to the connector itself. This presents a risk of direct contact with energized components.



5-Pin MSTB Connector

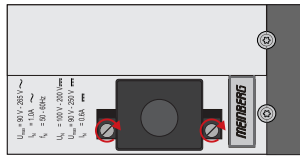

3-Pin MSTB Connector

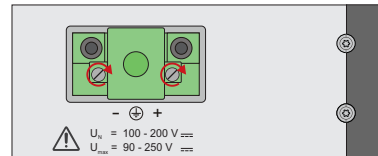

Illustration: Lock screws on an MSTB plug connector; in this case on a LANTIME M320

Ensure that all plug connections are secure. In particular, when using plug connectors with lock screws, ensure that the lock screws are securely tightened. This is especially important for power supply connectors where 3-pin or 5-pin MSTB connectors with lock screws are used (see illustration).

Before the device is connected to the power supply, the device housing must be grounded by connecting a grounding conductor to the grounding terminal of the device.

When installing the device in an electrical enclosure, it must be ensured that adequate clearance is provided, minimum creepage distances to adjacent conductors are maintained, and that there is no risk of short circuits.



Protect the device from the ingress of objects or liquids!

If the device malfunctions or requires servicing (for example, due to damage to the housing, power supply cable, or the ingress of liquids or objects), the power supply may be cut off. In this case, the device must be isolated immediately and physically from all power supplies! The following procedure must be followed in order to correctly and reliably isolate the device:

- Pull the power supply plug from the power source.
- Loosen the locking screws of the MSTB power supply plug on the device and pull it out of the device.
- Contact the person responsible for your electrical infrastructure.
- If your device is connected to one or more uninterruptible power supplies (UPS), the direct power supply connection between the device and the UPS solution must be first be disconnected.

### 4.5.1 Special Information for Devices with AC Power Supply

This device is a Protection Class 1 device and may only be connected to a grounded outlet (TN system).

For safe operation, the installation must be protected by a fuse rated for currents not exceeding 20 A and equipped with a residual-current circuit breaker in accordance with applicable national standards.



The appliance must only ever be disconnected from the mains power supply via the mains socket and not from the appliance itself.



Make sure that the mains socket on the appliance or the mains socket of the house installation is readily accessible for the user so that the mains cable can be pulled out of the socket in an emergency.

Non-compliant cabling or improperly grounded sockets are an electrical hazard!

Only connect the appliance to a grounded shockproof outlet using a safety-tested mains cable designed for use in the country of operation.

### 4.5.2 Special Information for Devices with DC Power Supply

In accordance with IEC 62368-1, it must be possible to disconnect the appliance from the supply voltage from a point other than the appliance itself (e.g., from the primary circuit breaker).



The power supply plug may only be fitted or dismantled while the appliance is isolated from the power supply (e.g., disconnected via the primary circuit breaker).



Power supply cables must have adequate fuse protection and have an adequate wire gauge size (1 mm<sup>2</sup> – 2.5 mm<sup>2</sup> / 17 AWG – 13 AWG)

The power supply of the device must have a suitable on-demand disconnection mechanism (i.e., a switch). This disconnection mechanism must be readily accessible in the vicinity of the appliance and marked accordingly as a disconnection mechanism for the appliance.

## 4.6 Safety when Handling SFP Modules

The SFP modules recommended by Meinberg are equipped with a Class 1 laser.



- Only use fiber-optic SFP modules that are compliant with the definition of a Class 1 laser in accordance with IEC standard 60825-1. Fiber-optic products that are not compliant with this standard may emit radiation capable of causing eye injuries.
- Never look into an unconnected connector of a fiber-optic cable or an unconnected SFP port.
- Unused fiber-optic connectors should always be fitted with a suitable protective cap.
- The safety information and manufacturer specifications relating to the SFP modules used must be heeded.
- The SFP module used must be capable of providing protection against voltage spikes in accordance with IEC 62368-1.
- The SFP module used must be tested and certified in accordance with applicable standards.





## 4.7 Safety when Maintaining and Cleaning the Device

Only use a soft, dry cloth to clean the device.

**Never** use liquids such as detergents or solvents to clean the device! The ingress of liquids into the device housing may cause short circuits in the electronic circuitry, which in turn can cause a fire or electric shock!



Neither the device nor its individual components may be opened. The device or its components may only be repaired by the manufacturer or by authorized personnel. Improperly performed repairs can put the user at significant risk!



In particular, **never** open a power supply unit or module, as hazardous voltages may be present within the power supply device even after it is isolated from the upstream voltage. If a power supply unit or module is no longer functional (for example due to a defect), it can be returned to Meinberg for repair.

Some components of the device may become very hot during operation. Do not touch these surfaces!

If maintenance work is to be performed on the device and the device housing is still hot, switch off the device beforehand and allow it to cool.

## 4.8 Battery Safety

The integrated CR2032 lithium battery has a service life of at least ten years.

Should it be necessary to replace the battery, please note the following:



- The battery may only be replaced by the same type or a comparable type recommended by the manufacturer.
- The battery may only be replaced by the manufacturer or authorized personnel.
- The battery must not be exposed to air pressure levels outside of the limits specified by the manufacturer.

Improper handling of the battery may result in the battery exploding or in leakages of flammable or corrosive liquids or gases.

- **Never** short-circuit the battery!
- **Never** attempt to recharge the battery!
- **Never** throw the battery in a fire or dispose of it in an oven!
- **Never** dispose of the battery in a mechanical shredder!

## 5 Important Product Information

### 5.1 CE Marking

This product bears the CE mark as is required to introduce the product into the EU Single Market.



The use of this mark is a declaration that the product is compliant with all requirements of the EU directives effective and applicable as at the time of manufacture of the product.

These directives are listed in the EU Declaration of Conformity, appended to this manual as Chapter 14.

### 5.2 UKCA Marking

This product bears the British UKCA mark as is required to introduce the product into the United Kingdom (excluding Northern Ireland, where the CE marking remains valid).



The use of this mark is a declaration that the product is in conformity with all requirements of the UK statutory instruments applicable and effective as at the time of manufacture of the product.

These statutory instruments are listed in the UK Declaration of Conformity, appended to this manual as Chapter 15.

### 5.3 Ensuring the Optimum Operation of Your Device

- Ensure that ventilation slots are not obscured or blocked by dust, or else heat may build up inside the device. While the system is designed to shut down safely and automatically in the event of temperature limits being exceeded, the risk of malfunctions and product damage following overheating cannot be entirely eliminated.
- The device is only deemed to be appropriately used and EMC limits (electromagnetic compatibility) are only deemed to be complied with while the device housing is fully assembled in order to ensure that requirements pertaining to cooling, fire safety, electrical shielding and (electro)magnetic shielding are upheld.

## 5.4 Maintenance and Modifications



### Important!

Before performing any maintenance work on or authorized modification to your Meinberg system, we recommend making a backup of any stored configuration data (e.g., to a USB flash drive from the Web Interface).

### 5.4.1 Replacing the Battery

Your device's clock module is fitted with a lithium battery (type CR2032) that is used to locally storage almanac data and sustain operation of the real-time clock (RTC) in the reference clock.

This battery has a life of at least ten years. However, if the device exhibits the following unexpected behaviors, the voltage of the battery may have dropped below 3 V, and the battery will need to be replaced:

- The reference clock has the wrong date or wrong date when the system is started.
- The reference clock repeatedly starts in Cold Boot mode (i.e., upon starting, the system has no ephemeris data saved whatsoever, resulting in the synchronization process taking a very long time due to the need to rediscover all of the visible satellites).
- Some configuration options relating to the reference clock are lost every time the system is restarted.

In this case you should not replace the battery on your own. Please contact the Meinberg Technical Support team, who will provide you with precise guidance on how to perform the replacement.

## 5.5 Prevention of ESD Damage



An **ESDS** device (electrostatic discharge-sensitive device) is any device at risk of damage or malfunction due to electrostatic discharge (ESD) and thus requires special measures to prevent such damage or malfunction. Systems and modules with ESDS devices usually bear this symbol.

Precautionary measures should be taken to protect ESDS components from damage and malfunction.

- Before removing or installing a module, ground your body first (for example, by touching a grounded object) before touching ESDS components.
- Ensure that you wear a grounding strap on your wrist when handling such ESDS components. These straps must in turn be attached to an uncoated, non-conductive metal part of the system.
- Use only tools and equipment that are free of static electricity.
- Ensure that your clothing is suitable for the handling of ESDS components. In particular, do not wear garments that are susceptible to electrostatic discharges (wool, polyester). Ensure that your shoes enable a low-resistance path for electrostatic charges to dissipate to the ground.
- Only touch or hold ESDS components by the edges. Never touch any pins or conductors on the ESDS components.
- When removing or installing ESDS components, avoid coming into contact with persons who are not grounded. Such contact may compromise your connection with the grounding conductor and thus also compromise the ESDS component's protection from any static charges you may be carrying.
- Always store ESDS components in ESD-proof ("antistatic") bags. These bags must not be damaged in any way. ESD-proof bags that are crumpled or have holes cannot provide effective protection against electrostatic discharges. ESD-proof bags must have a sufficient electrical resistance and must not be made of conductive metals if the ESDS component has a lithium battery fitted on it.

## 5.6 Disposal

### Disposal of Packaging Materials



The packaging materials that we use are fully recyclable:

Material	Used for	Disposal
Polystyrene	Packaging frame/filling material (e.g., polystyrene peanuts)	Recycling Depot
PE-LD (Low-density polyethylene)	Accessories packaging, bubble wrap	Recycling Depot
Cardboard	Shipping packaging, accessories packaging	Paper Recycling

For information on the proper disposal of packaging materials in your specific country, please inquire with your local waste disposal company or authority.

### Disposal of the Device



This product falls under the labeling obligations of the Waste Electrical and Electronic Equipment Directive 2012/19/EU ("*WEEE Directive*") and thus bears this WEEE symbol. The presence of this symbol indicates that this electronic product may only be disposed of in accordance with the following provisions.



#### Important!

Do not dispose of the product or batteries via the household waste. Inquire with your local waste disposal company or authority on how to best dispose of the product or battery if necessary.

This product is considered to be a "B2B" product for the purposes of the WEEE Directive and is also classified as "IT and Telecommunications Equipment" in accordance with Annex I of the Directive.

It can be returned to Meinberg for disposal. In this case, the shipping costs are to be borne by the customer, while Meinberg will cover the costs for disposal. If you wish for Meinberg to handle disposal for you, please get in touch with us. Otherwise, please use the return and collection systems provided within your country to ensure that your device is disposed of in a compliant fashion to protect the environment and conserve valuable resources.

### Disposal of Batteries

Please consult your local waste disposal regulations for information on the correct disposal of batteries as hazardous waste.

## 6 microSync Introduction

The **microSync** is Meinberg's versatile and powerful synchronization solution in a compact design. Depending on customer requirements, the microSync system is available with familiar input and output signals, such as PPS (pulse per second), Time Code AM and Time Code DCLS and programmable pulses, as well as with industry-specific signals such as Blackburst, DARS, Word Clock, etc. Furthermore, the microSync enables the synchronization of NTP clients and PTP slaves.

The device has four 100/1000 MBit network interfaces and can provide both, optical and electrical network connections by using SFP modules. It is possible to use different receiver variants, e.g. the 72-channel GNSS receiver for GPS, Galileo, GLONASS and BeiDou.

The sync optimized operating system supports NTP, PTP IEEE 1588 and a variety of protocols for management tasks.

### Product Highlights

- Powerful IEEE 1588 PTP Time Server incl. IEC/IEEE 61850-9-3 & IEEE C.37.238
- High performance (S)NTP server
- Half rack solution for a space efficient design
- Different Oscillator options for advanced holdover performance
- Meinberg Device Manager for configuration and status monitoring
- Three-year manufacturer's warranty
- Unlimited technical support including firmware updates

# 7 microSync RX800/AD10DC20 Connectors

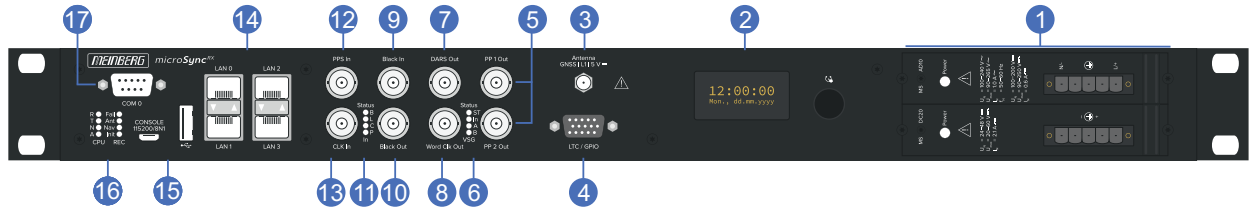

## 7.1 AC/DC Power Supply



### Important!

#### Hotplug

It is possible to remove or install power supplies from the system housing during operation.

#### Required Tools

- Slot screwdriver 0.4 mm thick, 2,5 mm wide
- Screwdriver Torx TR8x60

## Hints for Hot-Plug compatible Power Supplies

### Replacing the power supply unit

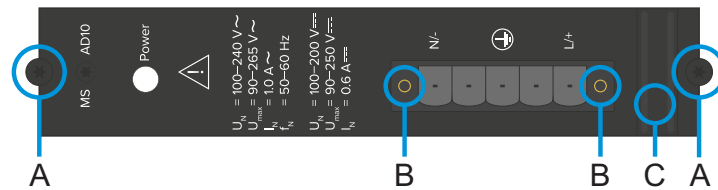

1. Interrupt the power supply of the power supply unit by pulling off the protective plug of the power cable.
2. Remove the 5-pin DFK-jack from the power supply after dissolving the two clamping screws (B) with the slot screwdriver.
3. Then loosen the two Torx screws (A) of the power supply that needs to be replaced with the Torx screwdriver (TR8).
4. The dissolved power supply can be removed with the handle (C) now.
5. Put the new power supply in the free slot and secure it with the two previously dissolved Torx fastening screws (A).
6. Connect the 5-pin DFK jack of the power cable to the power supply and put the two slit screws (B) back on.
7. The protective contact plug of the power cable can be reconnected to the power supply.
8. The LED of the new power supply should now light up. Furthermore, the status **Power Supply "green"** should be displayed in the Status System menu of the Meinberg Device Manager.

The status LED of the new power supply should now light up. The "OK" status must be displayed in the system's web interface.

### Checking Power Status

The status of the power supplies can be observed in the program *Meinberg Device Manager* under "Status → System Status".



## AD10 - AC/DC Power Supply

Connector Type:	5-pol. DFK
Pin Assignment:	1: N/- 2: not connected 3: PE (Protective Earth) 4: not connected 5: L/+

## Input Parameter

Nominal Voltage Range:	$U_N$	=	100-240 V $\sim$ 100-200 V $\overline{\sim}$
Maximum Voltage Range:	$U_{max}$	=	90-265 V $\sim$ 90-250 V $\overline{\sim}$
Nominal Current:	$I_N$	=	1.0 A $\sim$ 0.6 A $\overline{\sim}$
Nominal Frequency Range:	$f_N$	=	50-60Hz
Maximum Frequency Range:	$f_{max}$	=	47-63Hz

## Output Parameter

Maximum Power:	$P_{max}$	=	50 W
Max. Heat Emission:	$E_{therm}$	=	180.00 kJ/h (170.61 BTU/h)

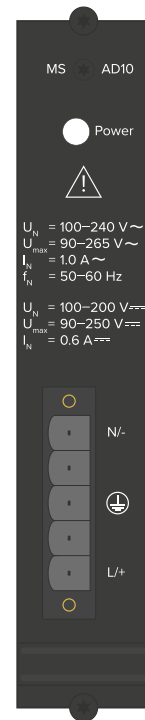

## Danger!

This equipment is operated at a hazardous voltage.

### Danger of death from electric shock!



- This device must be connected by qualified personnel (electricians) only.
- Never handle exposed terminals or plugs while the power is on.
- All connectors must provide protection against contact with live parts in the form of a suitable plug body!
- Note: Always ensure that wiring is safe!
- Important: The device must be grounded by means of a connection with a correctly installed protective earth conductor (PE).

## DC20 - DC Power Supply

**Connector Type:** 5pin DFK

**Pin Assignment:**

- 1: not connected
- 2:  $V_{IN-}$
- 3: PE (Protective Earth)
- 4:  $V_{IN+}$
- 5: not connected

### Input Parameter

**Nominal Voltage Range:**  $U_N = 24-48\text{ V} \overline{\overline{=}}$

**Maximum Voltage Range:**  $U_{max} = 20-60\text{ V} \overline{\overline{=}}$

**Nominal Current:**  $I_N = 2.10\text{ A} \overline{\overline{=}}$

### Output Parameter

**Maximum Power:**  $P_{max} = 50\text{ W}$

**Max. Heat Emission:**  $E_{therm} = 180.00\text{ kJ/h (170.61 BTU/h)}$

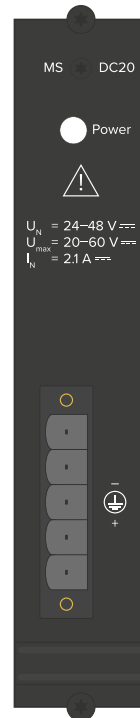

## 7.2 microSync OLED Display

For the microSync<sup>RX</sup> models an OLED display is optionally available. With this display the network management port LAN 0 can be configured for initial start of operation.

The configuration is limited to the setting of the IP address, the netmask, the gateway and the activation/de-activation of the DHCP service. In addition, the status of the receiver can be queried via the display:

- Time (time / date / offset)
- Status [sync, not sync or holdover].
- Technical data of the receiver
- Network configuration

In idle state, the display shows the time, date and sync status of the system.

You can navigate through the menu with the rotary knob, pressing the knob confirms your entry. In this way, submenus can be called up by pressing the knob or parameters can be reset. When a parameter change has been made, press and hold the rotary knob for a few seconds - "Save" will then appear. Use the rotary knob to select either "Yes" to save the configuration or "No" to exit the menu without saving the changes.

### Menu Navigation

#### 1. Start Display

Display of time / date / UTC offset and sync status

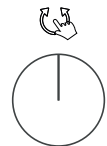
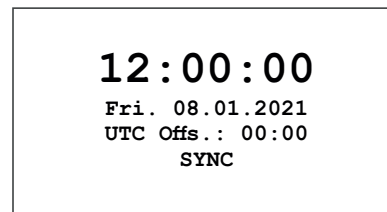

#### 2. Technical Data

The technical data provides the most important information about the connected system (i.e. the microSync) that is relevant for technical support or sales. In addition to the usual information, such as name and software version (SW → Software Version of the connected system), additional hardware-specific data, such as the FPGA, kernel or target version, are also shown in the display.

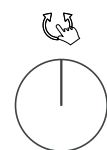
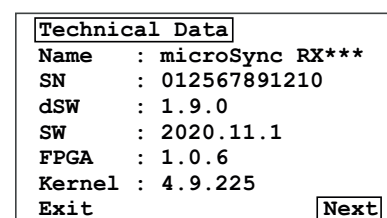

For optimum technical support, the Device Manager version (Devman), which should support all current functions, and the commit value, which is an internal identification for the software, are displayed.

- System type - e.g.: microSync RX800/AD10DC20
- SN - serial number
- dSW - display software version
- SW - firmware version
- FPGA - version
- Kernel - version

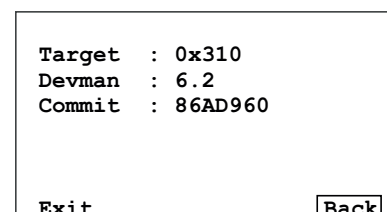

### 3. System Status Info

The hint "external changed" indicates that the configuration made via the display has been changed externally. This case occurs if e.g. the IP address, which was configured via the display, is changed by using the Meinberg Device Manager later.

- DHCP - On / Off
- IP address / Subnet mask
- Gateway
- Hostname

```

DHCP On
(*) external changed
IP Address:
166.030.044.002/16
Gateway:
166.030.000.001
Hostname:
mssb100                                Exit
    
```

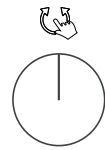

### 4. Network Parameters (DHCP On)

In this menu item only the DHCP service can be deactivated, all other parameters are set by the DHCP service.

```

Set Network Parm.
lan0:0

DHCP On                                Exit
    
```



```

DHCP On
DHCP On [Off]

Save: No [Yes]
    
```

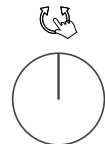

### 5. Network Parameter (DHCP Off)

After selection, the IP address can be entered by turning and pressing the rotary knob. The subnet mask and gateway can also be configured in the same way.

These settings are only possible if the DHCP service has been disabled before.

```

Set Network Parm.
lan0:0
IP Address
Subnetmask
Gateway
DHCP off                                Exit
    
```

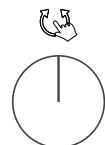

```

IP Address
00.000.000.000

Save: No [Yes]
    
```

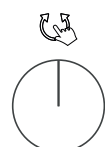

## 7.3 GNSS Antenna

Antenna type	Multi GNSS L1 antenna with integrated lightning protection
Receiver type	72-channel GPS/Galileo/Glonass/Beidou
Frequency band	L1 / E1 / B1 , 1575.42 +- 10 MHz / 1602-1615 MHz
Signal gain	40 dB
Antenna gain:	$\geq 3.5$ dBic / $\geq 3$ dBic
DC Voltage:	5 V (power supply via antenna cable)
DC Current:	max. 100 mA
Nominal impedance:	50 Ohm
Connection type:	SMA female
Cable:	shielded coaxial line, max. 70 m with Belden H155 coaxial cable

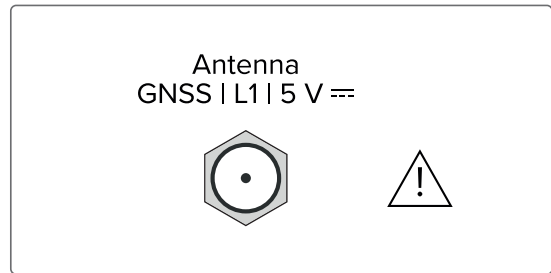

### Danger!

Do not work on the antenna system during thunderstorms!

**Danger of death from electric shock!**

- Do not carry out any work on the antenna system or the antenna cable if there is a risk of lightning strike.
- Do not carry out any work on the antenna system if it is not possible to maintain the prescribed safe distance to exposed lines and electrical substations.



## 7.4 LTC/GPIO

**Signal:** LTC-Reader (25 fps)

**Signal level:** TTL; 2,5 V<sub>ss</sub> (MARK/SPACE)  
at 50 Ohm

**Pin Assignment:**

- 1. LTC out - LTC symmetric Lo Pot. Output
- 2. LTC\_out + LTC symmetric Hi Pot. Output
- 3. LTC\_in + LTC symmetric Hi Pot. Input
- 4. LTC in - LTC symmetric Lo Pot. Input
- 5. LTC TTL in LTC, TTL-Level, Input
- 6. GND
- 7. GND
- 8. GND
- 9. GND
- 10. GND
- 11. DARS + DARS symmetric Hi Pot. Output
- 12. DARS - DARS symmetricLo-Pot. Output
- 13. n.c. not connected
- 14. TIME\_SYN TS-Output, TTL-Level
- 15. LTC TTL out LTC-Output, TTL-Level

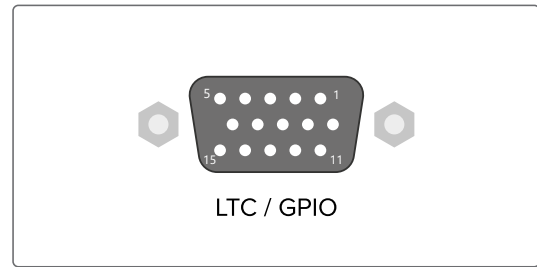

**Connection type** D-SUB female

**Cable:** Coaxial cable, shielded

## 7.5 Programmable Pulse Output

**Signal output** Programmable pulses

**Signal level:** TTL; 2.5 V into 50 Ohm

**Connector:** BNC, female

**Cable:** Coaxial cable, shielded

**Mode:** Idle  
Timer  
Single Shot  
Cyclic Pulse  
Pulse Per Second  
Pulse Per Minute  
Pulse Per Hour  
DCF77 Marks  
Position OK  
Time Sync  
All Sync  
DCLS Time Code  
Serial Time String  
10 MHz Frequency  
DCF77-like M59  
Synthesizer Frequency  
PTTI 1 PPS  
1 MHz Frequency  
5 MHz Frequency

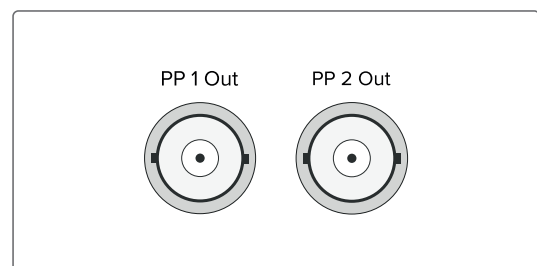

## 7.6 Status LEDs - VSG Signals

### Status indicator

LED St:	Status of the internal VSG
LED In:	Synchronization status
LED A:	Status of the blackburst output
LED B:	Status of the LTC output

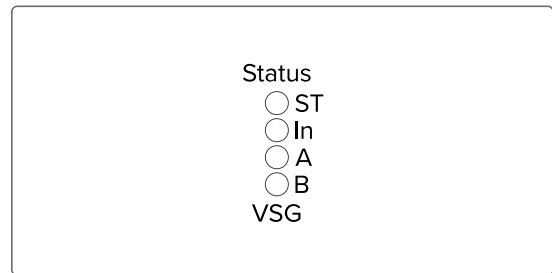

The status messages of the LEDs result as follows:

### LED St:

Blue	During initialization
Green	During operation

### LED In:

Shows status after initialization

Green	Accurate (accuracy of $\leq 200$ ns to reference).
Green Flashing	Timesync
Yellow	Insufficient quality of the reference signal.
Red	Reference signal not available / internal VSG is not synchronous

### LED A - Status *Black Out*

1 sec Red -> 1 sec Yellow -> 1 sec Green -> 1 sec Off

Off	Output switched off
Green blinking	Timing pattern of the signal is corrected
Yellow flashing	Timing pattern of the signal is corrected
Green on	Output on, control is in 'warmed up' state (fine control )
Yellow light	Output on, control not yet in 'warmed up' state (coarse control)

### LED B - Status *LTC Out*

1 sec red -> 1 sec yellow -> 1 sec green -> 1 sec off

Off	Output switched off
Green blinking	Timing pattern of the signal is corrected
Yellow flashing	Timing pattern of the signal is corrected
Green on	Output on, control is in 'warmed up' state (fine control)
Yellow glowing	Output on, control not yet in 'warmed up' state (coarse control)

## 7.7 DARS Output

<b>Output signal:</b>	DARS
<b>Signal level:</b>	TTL; 2.5 V <sub>SS</sub> into 75 ohms
<b>Signal type:</b>	Base frequencies: 44.1 kHz and 48 kHz
<b>Connection type:</b>	BNC female connector
<b>Cable:</b>	Coaxial cable, shielded

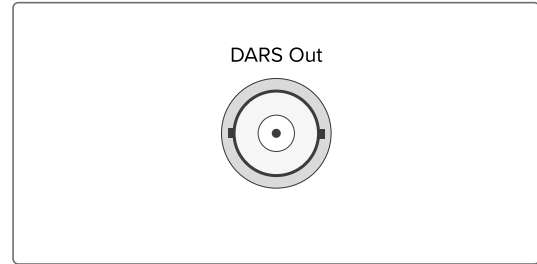

## 7.8 Word Clock Output

<b>Output signal:</b>	Word Clock
<b>Signal level:</b>	TTL; 2.5 V <sub>SS</sub> into 75 ohms
<hr/>	
<b>Base frequency:</b>	44.1 kHz
<b>Frequency range:</b>	1.378125 kHz ... 1.4112 MHz
<b>Multipliers:</b>	1/32, 1/16, 1/8, 1/4, 1/2, 1, 2, 4, 8, 16, 32
<hr/>	
<b>Base frequency:</b>	48 kHz
<b>Frequency range:</b>	1.5 kHz ... 1.536 MHz
<b>Multipliers:</b>	1/32, 1/16, 1/8, 1/4, 1/2, 1, 2, 4, 8, 16, 32
<hr/>	
<b>Connection type:</b>	BNC female connector.
<b>Cable:</b>	Coaxial cable, shielded

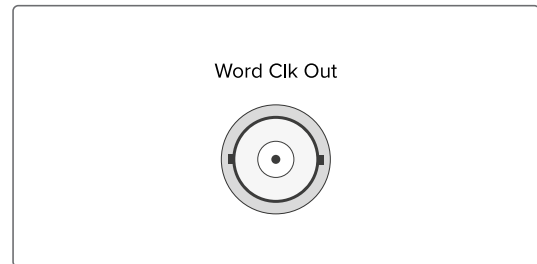



## 7.9 Blackburst Input

<b>Input Signal</b>	Black Burst (PAL) Input with VITC Reader Input with Prescaler mode (Frequency only)
<b>Signal level:</b>	300 mV <sub>ss</sub> into 75 ohms (unbalanced)
<b>Time Code Formats:</b>	PAL SMPTE259M / ITU-R BT.470-6 SMPTE12M-1 / SMPTE ST309M
<b>Connection type:</b>	BNC female connector
<b>Cable:</b>	Coaxial cable, shielded

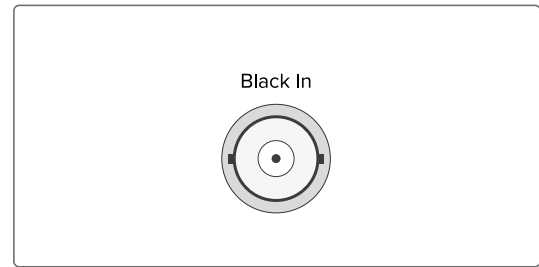

## 7.10 Blackburst Output

<b>Output Signal:</b>	PAL, NTSC Black Burst with VITC Support
<b>Signal level:</b>	300 mV <sub>ss</sub> into 75 ohms (unbalanced)
<b>Formats:</b>	Black Burst: PAL (SMPTE259M/ITU-R BT.470-6) NTSC (SMPTE170M/ITU-R BT.470-7) VITC (SMPTE12M-1/SMPTE ST309M)  Tri-Level Sync: 720p 50 Hz (SMPTE296M3) 1080i 25 Hz (SMPTE274M6) 720p 59.94 Hz (SMPTE296M1) 1080i 29.97 Hz (SMPTE274M7)
<b>Connection type:</b>	BNC female connector
<b>Cable:</b>	Coaxial cable, shielded

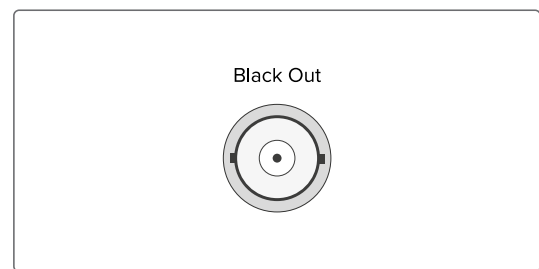

## 7.11 Status LEDs - input signals

### Status indicator

LED B: Status of the blackburst input signal.  
 LED L: Status of the LTC input signal  
 LED C: Status of the Word Clock input signal  
 LED P: Status of the PPS input signal

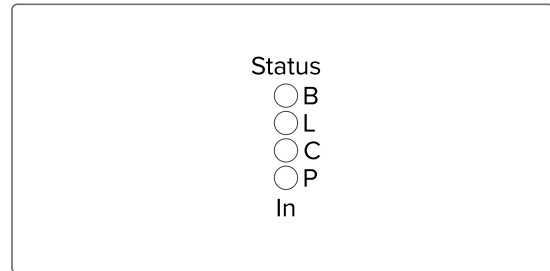

The status messages of the LEDs are as follows:.

### LED B (Blackburst In).

1 sec Red -> 1 sec Yellow -> 1 sec Green -> 1 sec Off.

Blue	During initialization
Green	During operation
Yellow	Insufficient quality of reference signal.
Red	Reference signal not available / signals not synchronous

### LED L (LTC In)

1 sec Red -> 1 sec Yellow -> 1 sec Green -> 1 sec Off

Blue	During initialization
Green	During operation
Yellow	Insufficient quality of reference signal
Red	Reference signal not available / signals not synchronous

### LED C (Word Clock In)

1 sec Red -> 1 sec Yellow -> 1 sec Green -> 1 sec Off

Blue	During initialization
Green	During operation
Yellow	Insufficient quality of the reference signal
Red	Reference signal not available / signals not synchronous

### LED P (PPS In)

1 sec Red -> 1 sec Yellow -> 1 sec Green -> 1 sec Off

Blue	During initialization
Green	During operation
Yellow	Insufficient quality of reference signal
Red	Reference signal not available / signals not synchronous

## 7.12 Pulse Per Second Input

Input signal	PPS (pulse per second)
Signal level:	TTL
Pulse length:	$\geq 5 \mu s$ , active high
Connection type:	BNC, female
Cable:	Coaxial cable, shielded

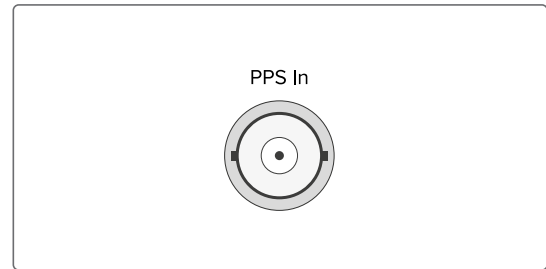

## 7.13 Word Clock Input

Input signal:	Word Clock Input with programmable frequency range
Signal level:	TTL
Frequency range:	1 kHz - 10 MHz
Cable:	Coaxial cable, shielded

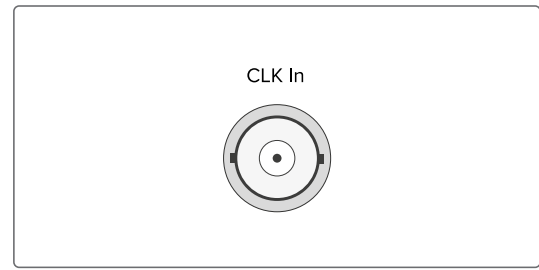

## 7.14 LAN Network Interfaces

Gigabit Ethernet (GbE), 100/1000 MBit - SFP

LAN 0, 1: Management / NTP  
10/100/1000Mbit RJ45 or 1000FX

LAN 2, 3: Management  
10/100/1000Mbit RJ45 or 1000FX  
NTP / PTP

Synchronous Ethernet:  
Master and Slave Capability  
Compliant to ITU-T G.8261, G.8262 and G.8264  
Ethernet Synchronization Messaging Channel (ESMC)

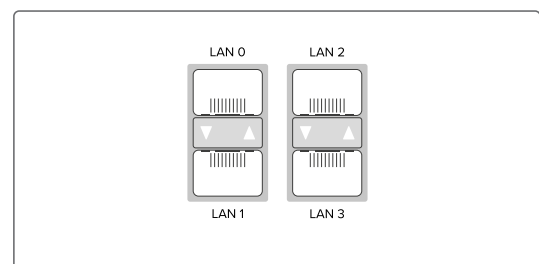

## Available SFP Modules

### SFP Transceivers Recommended and Tested by Meinberg



Output Type	Manufacturer Designation
Multi Mode:	Avago AFBR-5710PZ Finisar FTLF8524P3BNL Cisco GLC-SX-MMD
Single Mode:	Avago AFCT-5710PZ Finisar FTLF1318P3BTL
RJ-45:	Avago ABCU-5740RZ Finisar FCLF8521P2BTL

### Warning!



#### Prevention of Eye Injuries

- Fiber optic SFP modules that are not compliant with the definition of a Class 1 laser in accordance with IEC standard 60825-1 may emit radiation capable of causing eye injuries.
- Never look into an unconnected connector of a fiber optic cable or an unconnected SFP port, and ensure that unused fiber optic connectors are always fitted with a suitable protective cap.

## 7.15 USB Interface

Signal	Signal Type	Connector
USB Terminal	USB-to-serial console	Micro-USB Type B
USB Host	USB connector management CPU	USB Type A

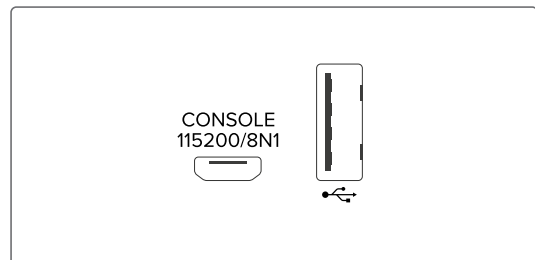

## 7.16 Status Indicators - CPU and Receiver

### CPU:

#### R (Receiver)

green: The reference clock (e.g. build-in GNS) provides a valid time

red: the reference clock does not provide a valid time

#### T (Time Service)

green: NTP is synchronized to the reference clock, e.g. GNS

red: NTP is not synchronized or switched to the "local clock"

#### N (Network)

green: All monitored network interfaces are connected ("Link up")

red: At least one of the monitored network interfaces is faulty

#### A (Alarm)

off: No error

red: General error

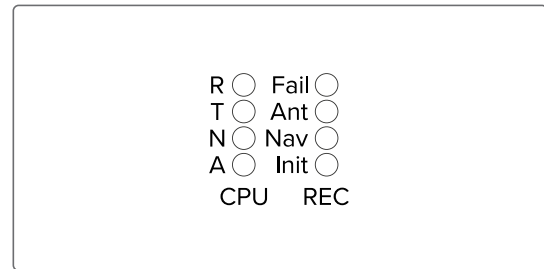

### REC:

#### Fail

red: No synchronization

#### Ant

red: No synchronization resp. no antenna connected or short circuit on the antenna line

green: Antenna connected and clock is synchronized

#### Nav

green: Positioning complete

#### Init

blue: Initialisation phase

green: "warmed up" - oscillator is adjusted

## 7.17 RS-232 COMx Timestring

**Data transfer:** serial  
**Baudrate/framing:** 19200 / 8N1 (default)  
**Time-string:** Meinberg Standard (default)

**Assignment:**

Pin 2: RxD (receive)  
Pin 3: TxD (transmit)  
Pin 5: GND (ground)

**Connector:** 9pin D-SUB male

**Cable:** data cable (shielded)  
PC connector 1:1

**Synchronization with PPS + String:**

**Pin 1 - PPS In**

Signal level: TTL

Pulse length:  $\geq 5 \mu s$  (active high)

**Pin 2 - String\* In (RxD)**

\* The following timestrings (time telegrams) can be used:

NMEA RMC

NMEA ZDA

Meinberg Standard

Uni Erlangen

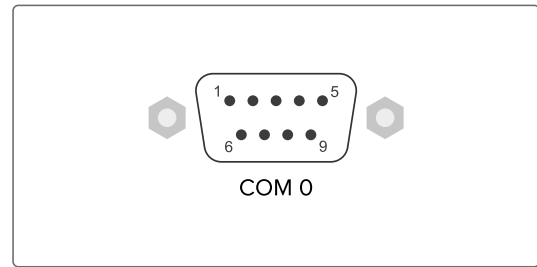

# 8 Information on Satellite Reception

## 8.1 Multi GNSS Satellite Receiver

Your system is fitted with the GNS, a 72-channel satellite receiver clock which serves as a high-accuracy time reference and high-precision frequency reference for your Meinberg system and is designed to receive signals from the United States GPS (Global Positioning System), Russian GLONASS (GLObal NAVigation Satellite System), the European Galileo system, and the Chinese BeiDou system. This enables your Meinberg system to be used practically anywhere in the world.

The GNSS reference clock allows for simultaneous reception of signals from up to three of these systems, and the system can be configured to allow only signals from selected satellite systems. It is possible, for example, to exclude a certain system as needed, or restrict reception to a single satellite system.

## 8.2 How Satellite Navigation Works

The use of a receiver for location tracking and time synchronization relies on the ability to measure the satellite-to-receiver propagation delay as precisely as possible. It is necessary to have simultaneous reception from four satellites so that the receiver can determine its relative spatial position in three dimensions (x, y, z) and measure the deviation of its clock against the system clock. Monitoring stations around the planet track the orbital trajectory of the satellites and detect deviations between the local atomic clocks and the system time. The collected data is transmitted up to the satellites, which then send navigation data back to Earth.

The high-precision trajectory data of each satellite, known as the satellite's ephemeris, is needed by the receiver to continuously calculate the precise location of the satellites in space. A roughly defined ephemeridal schedule based on empirical data, referred to as an almanac, is used by a receiver to identify which satellites are visible above the horizon given a known approximate location and time. Each satellite transmits its own ephemeridal schedule as well as the almanacs of all existing satellites.

### Satellite Systems

**GPS** was installed by the United States Department of Defense (US DoD) and operates at two performance levels: the Standard Positioning Service, or SPS, and the Precise Positioning Service, or PPS. The structure of the messages transmitted by the SPS has been openly published and reception is provided for public use. The timing and navigation data of the more precise PPS is encrypted and is thus only accessible to certain (usually military) users.

**GLONASS** was originally developed by the Russian military for real-time navigation and ballistic missile guidance systems. GLONASS satellites also send two types of signal: a Standard Precision Signal (SP) and an encrypted High Precision Signal (HP).

**BeiDou** is a Chinese satellite navigation system. The second-generation system, officially referred to as the BeiDou Navigation Satellite System (BDS) and also known as "COMPASS", consists of 35 satellites. BeiDou entered service in December 2011 with ten satellites and was made available to users in the Asia-Pacific region. The system was completed in June 2020 with the launch of the final satellite.

**Galileo** is an in-development global European satellite navigation and time reference system controlled by a civilian authority (European Union Agency for the Space Programme, EUSPA). Its purpose is the worldwide delivery of high-precision navigation data and is similarly structured to the American GPS, Russian GLONASS and Chinese BeiDou systems. The main differences in the systems lie in their approaches to frequency usage & modulation and the satellite constellation.

### 8.2.1 Time Zones and Daylight Saving Time

GPS System Time is a linear timescale that was synchronized with the international UTC timescale (Coordinated Universal Time) when the satellite system became operational in 1980. Since it has entered service, however, several leap seconds have been introduced to the UTC timescale to adjust UTC time to irregularities in the Earth's rotation. While GPS System Time deviates from UTC time by several seconds for this very reason, satellite messages do incorporate the number of seconds by which these timescales deviate from one another, allowing GPS receivers to be synchronized internally with the international UTC timescale.

The receiver's microprocessor can identify any time zone based on UTC time and automatically apply Daylight Saving Time adjustments over several years if so configured by the user.



## 9 GNSS Antenna Installation

Two different antennas are available for our combined GPS/GLONASS/Galileo/BeiDou satellite receivers that are each designed to fulfill different tasks or applications.

The active Multi-GNSS L1 antenna is the standard accessory and can receive signals from the GPS, GLONASS, Galileo, and BeiDou satellite systems. This antenna is ideal for fixed-location systems, operates using a 5 V DC supply voltage supplied by the receiver, and features an integrated surge protector.

For mobile applications, such as cars, RVs, vans, ships, trains, and aircraft, we recommend the use of the RV-76G, an active GNSS antenna that is suitable for direct installation in an enclosure (chassis, panels, etc.)

## 9.1 Installation of the Multi-GNSS Antenna



### Danger!

Do not mount the antenna without an effective fall arrester!

**Danger of death from falling!**

- Ensure that all necessary safety measures are taken when installing an antenna!
- In particular, never work without an effective fall arrester!



### Danger!

Do not work on the antenna system during thunderstorms!

**Danger of death from electric shock!**

- Do not carry out any work on the antenna system or the antenna cable if there is a risk of lightning strike.
- Do not carry out any work on the antenna system if it is not possible to maintain the prescribed safe distance to exposed lines and electrical substations.

## Selecting the Antenna Location

To avoid difficulties with synchronization, select a location that allows for an unobstructed view of the sky so as to ensure that enough satellites can be found. The line of sight between the antenna and satellites should not be obstructed in any way. The antenna must also not be installed under power lines or other electrical lighting or power circuits.

### Installation Conditions for Optimum Operation:

- clear view of 8° above the horizon or
- clear view towards equator (if clear view of 8° not possible) or
- clear view between 55th north and 55th south parallels (satellite orbits).



### Information:

Problems may arise if all of these views are obstructed, as four satellites must be located to calculate a new position.

## Important Information Regarding Surge Protection

The following illustration is a visual representation of where there is a risk of hazardous voltage surges in the cable route (from antenna to Meinberg system). The examples below explain how you can protect your Meinberg system from these.

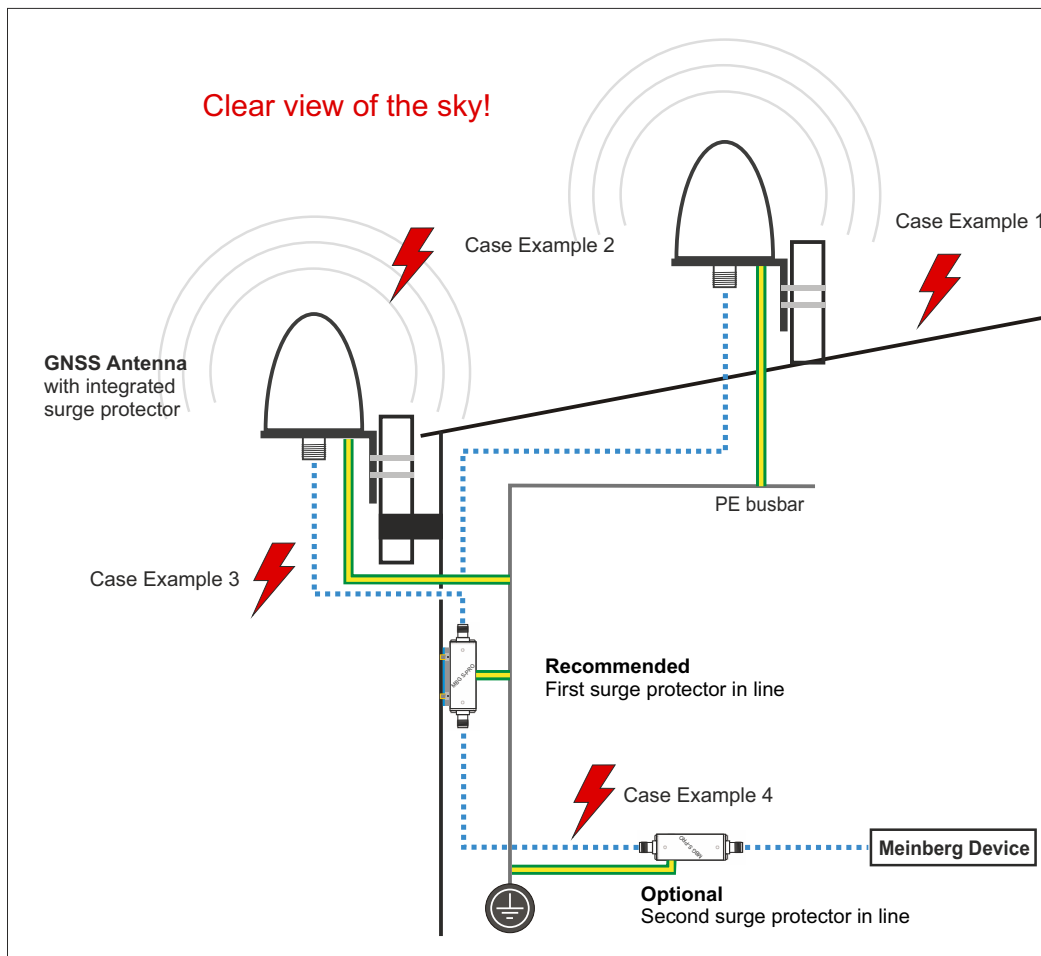

### Case Example 1:

An indirect lightning strike near the antenna or coaxial cable may induce transient voltages ("spikes" or "surges"). These spikes can be carried via the coaxial cable to the inside of the building and consequently to the system's receiver. It is therefore strongly recommended to have the surge protector installed at the point directly after the cable enters the building.

### Case Example 2:

In the event of a direct lightning strike on the antenna, the resultant transient voltage may be discharged via the PE busbar (GNS L1 antenna only). This prevents the transient voltage from being carried to the coaxial cable and subsequently to the system's receiver.

### Case Example 3:

If the length of the coaxial cable between the antenna and point of entry into the building is rather long (e.g., 10 meters), there is a greater risk of transient voltages being introduced into the antenna cable as a result of lightning strike. In this case, the integrated surge protector of the GNSS antenna may not be adequate, so the installation of a surge protector immediately after the point of entry into the building is also strongly recommended here.

### Case Example 4:

If the cable leading from the point of entry into the building to the Meinberg system is laid together with other cables (for example in a cable duct alongside high-voltage cables), transient voltages may "leak" into the antenna cable, causing damage to your system. To prevent this, a second surge protector can optionally be installed in the line just before the device.

## Mounting the Antenna

1.

Use the included mounting kit to mount the L1 antenna at a distance of 50 cm from other antennas on a vertical pole of a diameter of between 60 mm and 215 mm (2½"-8½").

The antenna cable should then be connected to the Type-N connector of the antenna.

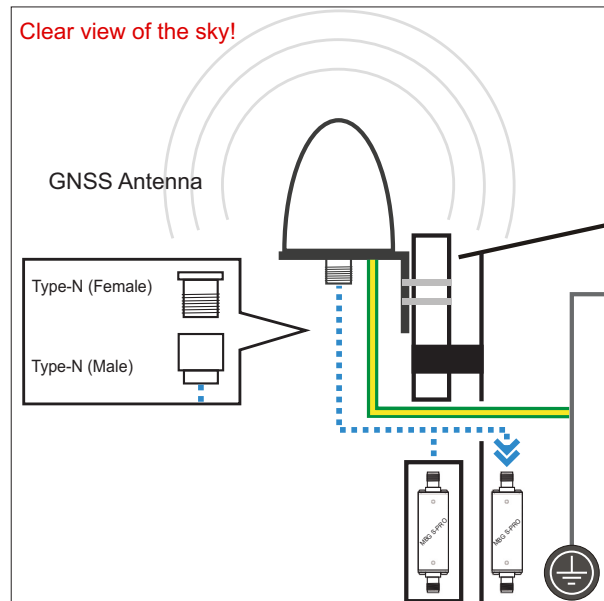

### Information:

Make sure that the maximum cable length is not exceeded when installing the antenna cable between the antenna and receiver. The maximum length will depend on the type of cable used (RG213, RG58) and its attenuation factor.

2.

Voltage surges (e.g., caused by lightning strike) may be transmitted along the antenna cable and cause damage to the receiver. Using an MBG S-PRO surge protector can help to protect your receiver against such surges.

If installed in a waterproof housing, the MBG S-PRO can be installed outdoors. However, Meinberg recommends installing the surge protector indoors—as closely to the entrance point of the antenna cable as possible—in order to minimize the risk of surge damage (such as that caused by lightning strike).

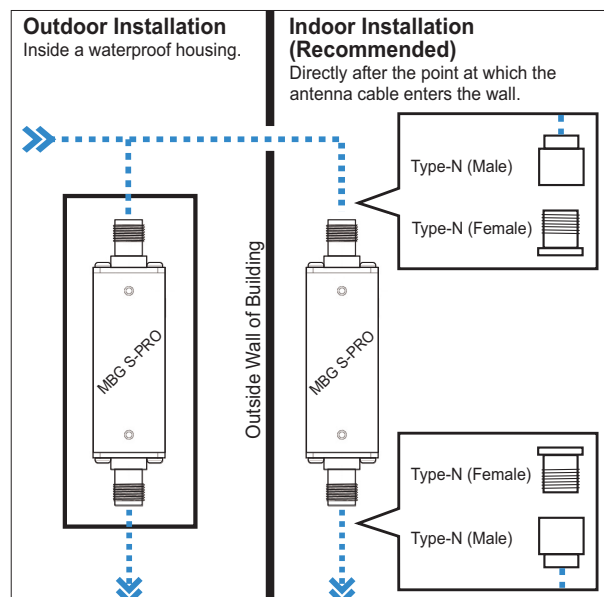

## 3.

To ground the antenna cable, connect the surge protector to a grounding busbar using a grounding conductor (see illustration).

Once installation is complete, connect the other end of the antenna cable to the surge protector female connector.

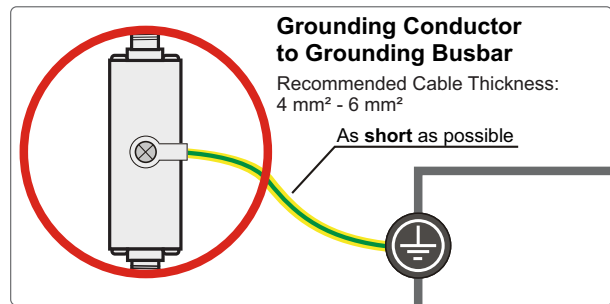

## 4.

The next step is to connect the supplied coaxial cable from the surge protector to the receiver.

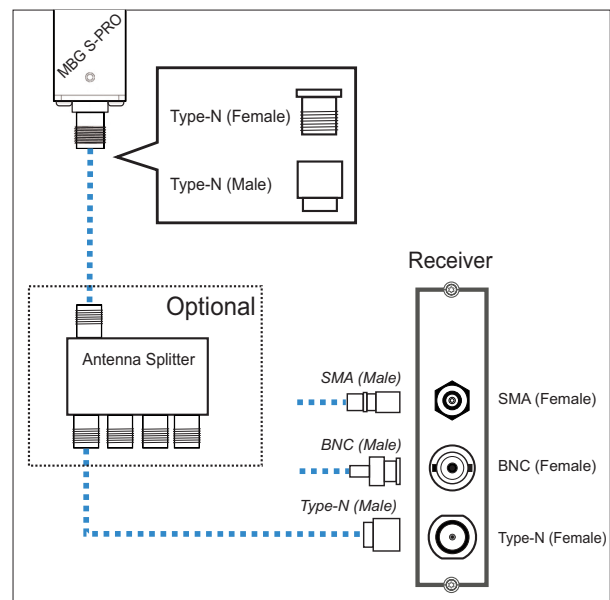

### Optional Antenna Splitter

Multiple receivers can be connected to one antenna using the antenna splitter. When doing so, be aware that the total distance, comprising the cable from the antenna to the splitter, and from there to the receiver, must not exceed the maximum cable length. The splitter may be installed at any location between the surge protector and the receivers.



#### Information:

It is not possible to directly connect a Meinberg GPS antenna/converter unit to an L1 antenna splitter.

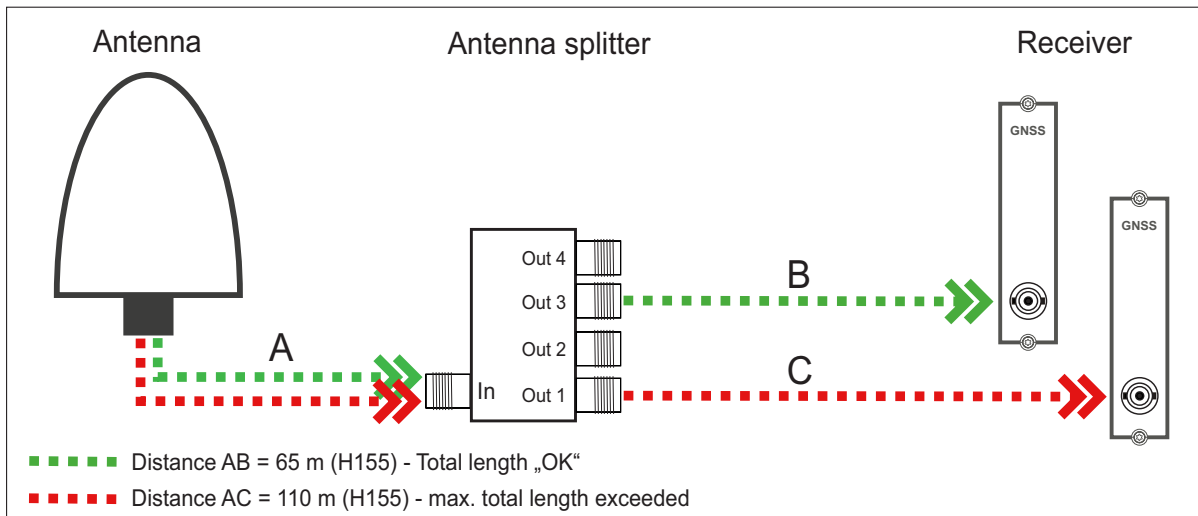

### Compensating for Signal Propagation Delay in the Antenna Cable

To enable the connected receiver to compensate for the signal propagation delay inherent in the antenna cable, you will need to enter either the length of your antenna cable in meters or the offset time in nanoseconds into your receiver.

To do so, go to the web interface of your system to the menu "Clock" -> Status u. Configuration -> Miscellaneous

#### Antenna Cable Length (m):

The satellite signal reception is delayed as a result of coaxial cable used.

Cable	Delay	Usage
RG58U	5 ns/m	For GPS and GNS-UC receivers
H155	4 ns/m	For GNS and GNM receivers

The cable length entered (from antenna to receiver) is used by the system to calculate the delay time and to automatically compensate for propagation delay. A value of 20 m is set by default.

When using a different type of coaxial cable, please use the "By Delay" option. You will need to calculate the delay yourself using the information provided in the product specifications provided by the manufacturer of your coaxial cable.

## 9.2 Technical Specifications: RV-76G GPS/GLONASS Antenna for Mobile Applications

### Installation of the Antenna

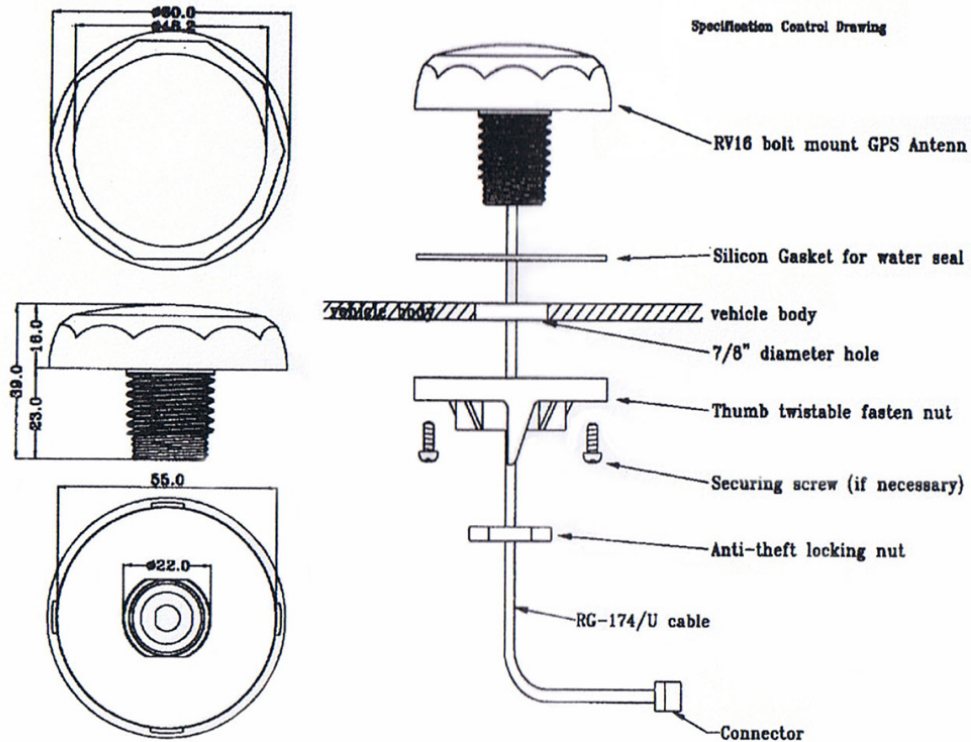

### Further Information on the Product

Detailed specifications are provided in the manufacturer's data sheet.

Source: *RV-76G\_Catalog\_V1.0\_20130502 Data Sheet (Sanav)*

Download: [https://www.meinbergglobal.com/download/docs/other/rv-76g\\_en.pdf](https://www.meinbergglobal.com/download/docs/other/rv-76g_en.pdf)

# 10 Starting of Operation

## 10.1 Initial Network Configuration

Once the microSync has been successfully started, the initial setup process can be performed.

The microSync is shipped with DHCP disabled and a statically configured IP address. This means that a network connection must be manually established to be able to setup the device fully.

There are three ways to perform the basic network configuration of your microSync:

- Configuration via a serial connection, see Chapter 10.1.1.
- Configuration via the Web Interface, see Chapter 10.1.2.
- Configuration via Meinberg Device Manager, see Chapter 10.1.3.



### 10.1.1 Network Configuration via Serial Connection

The initial network configuration of the microSync can also be performed via a serial USB connection. You can connect the USB port on the PC with the micro-USB port of the microSync using a standard USB cable (Micro-USB Type B to USB-A). Your PC will recognize this connection as a serial connection.

Under Windows, you can identify which COM interface is used to communicate by opening the Device Manager. The information is usually provided under the group "*Ports (COM & LPT)*".

In many commonly used Linux distributions, the output of the terminal command *dmesg* can be used to identify which serial interface is to be used to communicate with the microSync. The relevant entry would look something like this:

```
[77833.359948] usb 1-1.2.1.6.3: FTDI USB Serial Device converter now
attached to ttyUSB0
```

This reveals, for example, that you should establish a connection via */dev/ttyUSB0*.

You can now use a terminal client such as PuTTY to establish a serial connection with the system.

Use the following connection parameters:

**Conn. Type:** Serial

**Serial Line:** The serial interface identified as above (e.g., *COM13* or */dev/ttyUSB0*)

**Speed:** 115200

**Framing:** 8N1

Once the connection has been detected, you will be prompted to enter a username and password. User: *admin* / Password: *timeserver*. Press the Enter key after each entry.

Once a connection has been successfully established, you can use the meinbergOS Wizard to perform the initial network configuration.

First, launch the wizard by entering *mbgOSWizard.sh*; this will prompt you to enter the password (Default: *timeserver*).

You can now select the physical network interface that you wish to use for management purposes. The next step is to enter the IPv4 address that you wish to assign to the selected port. The final step is to enter the subnet mask (e.g., *255.255.255.0*). You can then confirm your entries with *'y'*.

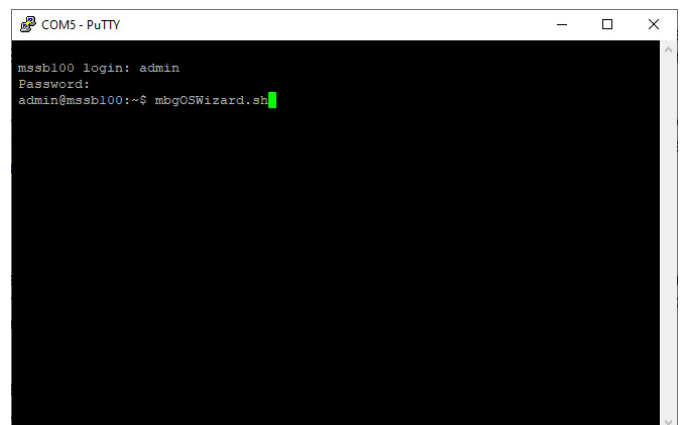

The initial network configuration process is now complete and you can close the setup wizard. All further configuration can be performed using the Web Interface or Meinberg Device Manager.



### Information:

If the microSync's network configuration has already been previously performed using the Web Interface or Meinberg Device Manager, you will not be able to do this using *mbgOSWizard.sh*.

### 10.1.2 Network Configuration via Web Interface

The network configuration for the microSync can be performed via the Web Interface. In its factory-shipped state, the microSync has the following network configuration:

#### Network Port LAN 0

IPv4 Address: 192.168.19.79

Subnet Mask: 255.255.255.0

Gateway: Not defined

DHCP: Disabled

The PC from which the Web Interface will be accessed via a browser must be able to establish a network connection with the above address in the appropriate subnet. If the PC's network configuration or the network's topology or addressing prevent a connection from being established with the microSync, the network configuration of the PC will need to be (temporarily) changed and a different physical connection may need to be established (e.g. a direct network connection).

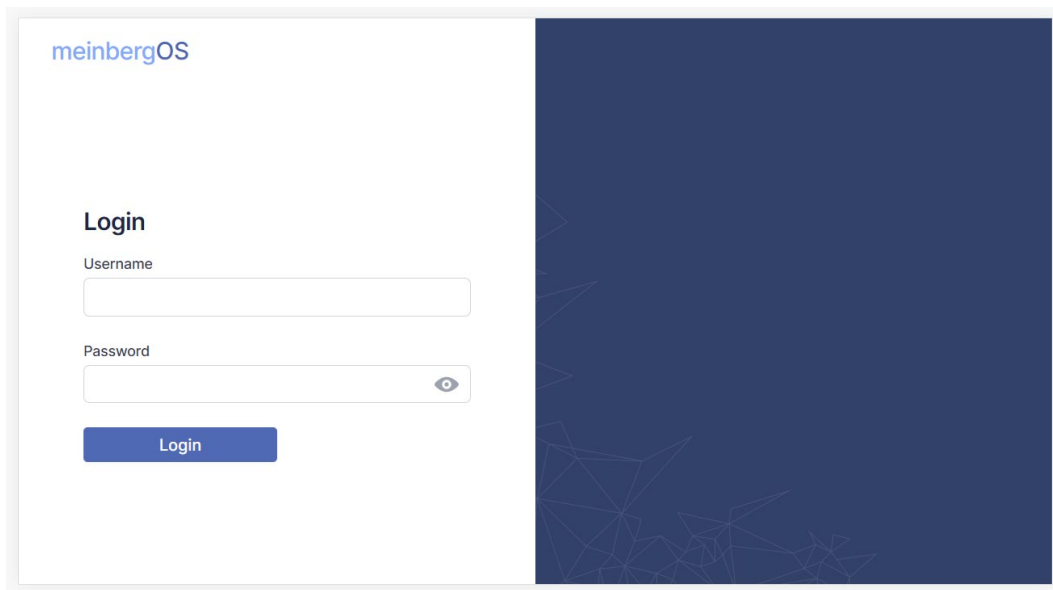

Open a web browser of your choice and open the address <https://192.168.19.79>. This should bring up the login page. Enter "admin" as the username and "timeserver" as the password.

Configuration > Network

## Network

State → Save

Main Interfaces PRP Bonding Extended Configuration

Main network configuration parameters. API /configuration/network/main

Hostname  Default Gateway (IPv4)

Default Gateway (IPv6)

DNS Servers (3/3) Domain name servers used for name resolution. + Add DNS Server

<input type="text" value="172.16.3.11"/>	Edit	Remove
--	------	--------

As soon as the Dashboard appears, click on the "Configuration" section in the Header Bar, then select the "Network" tile. Be sure in particular to correctly configure the network settings for the intended management interface ("Interfaces" tab) to ensure that it is accessible within the subnet.

Once you have performed the configuration, click on "Save" to store the changes.

### 10.1.3 Network Configuration via Meinberg Device Manager

#### Meinberg Device Manager

The Meinberg Device Manager software is a graphical desktop application that allows to configure Meinberg modules and assembly groups over an encrypted network connection or a local USB or serial connection. A great advantage of the Meinberg Device Manager is that various modules/assembly groups can be configured and monitored simultaneously. The Meinberg Device Manager for Windows can be used under Windows 7 and all newer versions. Supported Linux distributions include Ubuntu, Mint Linux, Debian, SUSE Linux, CentOS, and others.

The software does not need to be installed or copied on the PC. The Meinberg Device Manager can be started directly from an USB storage device. The computer must be connected to the network in which the microSync system is connected.

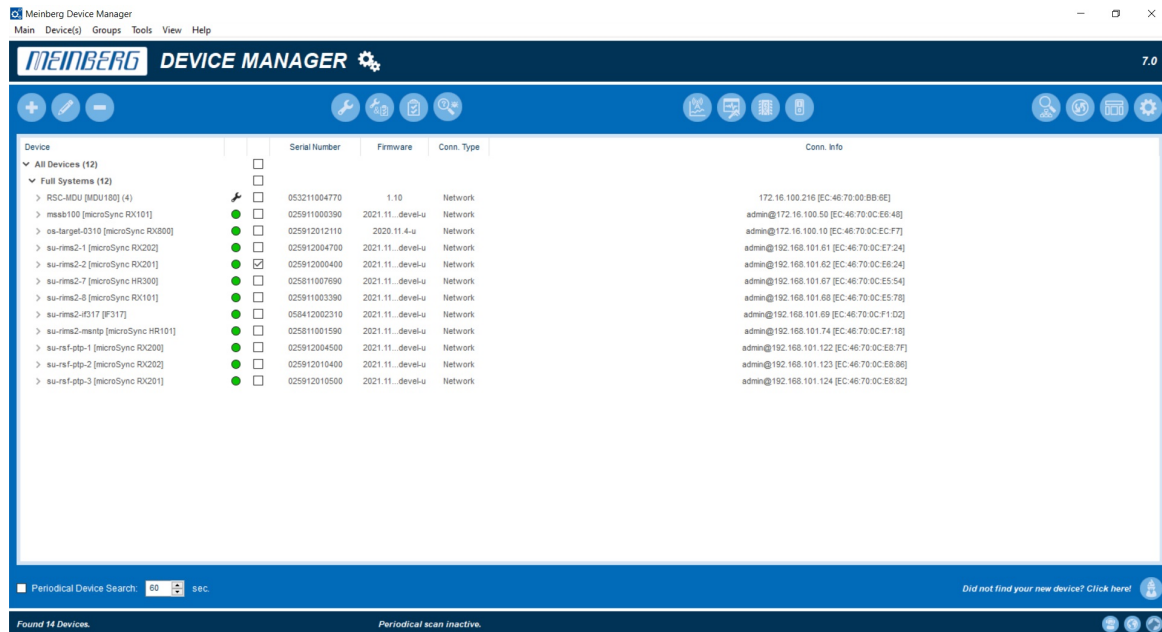

The Meinberg Device Manager software is downloadable free of charge from our homepage:  
<https://www.meinbergglobal.com/english/sw/mbg-devman.htm>



#### Information:

You can download a complete and detailed manual about the Meinberg monitoring software on our homepage:

<https://www.meinbergglobal.com/download/docs/manuals/english/meinberg-device-manager.pdf>

The network configuration for the microSync can be performed using Meinberg Device Manager – see chapter "Additional Software" in the microSync installation manual.

In its factory-shipped state the microSync has the following network configuration:

### Netzwerkport LAN 0

IPv4 Adresse    *192.168.19.79*

Netzmaske:    *255.255.255.0*

Gateway:        Not defined

DHCP:            Disabled

The PC on which Meinberg Device Manager is used must be able to establish a network connection with the above address in the appropriate subnet. If the PC's network configuration or the network's topology or addressing prevent a connection from being established with the microSync, the network configuration of the PC will need to be (temporarily) changed and a different physical connection may need to be established (e.g. a direct network connection).



### Important!

Please ensure that any effective firewalls or other security solutions allow network traffic to pass through TCP port *10002*.

Clicking on the button "**Search Devices**" will cause all Meinberg products accessible over the network connection to be detected and then listed.

Select the device with which you wish to establish a connection. With the microSync, you will then be prompted to enter your account details. When setting the device up for the first time, please enter "*admin*" as the username and "*timeserver*" as the password.

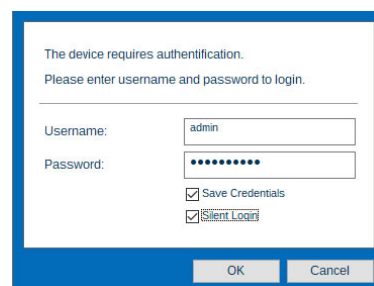



If the inserted microSync cannot be found via the automatic search, the **Add Device** button can be used to set up the connection manually.

### Manual Setup

Select the connection type  
**microSyncHR, microSyncRX (Network)**.

Then enter the IPv4 address of the microSync (192.168.19.79). Enter "admin" as the username and "timeserver" as the password.

Once the network connection has been established, open the "Network" section of the left "Config" panel, then make the appropriate adjustments to the network settings. Be sure in particular to correctly configure the network settings for the intended management interface ("Interfaces" tab) to ensure that it is accessible within the subnet.

Once you have performed the configuration, click on "Apply Configuration" (the check mark) to store the changes.

## 10.2 Initial Start of Operation

### 10.2.1 Start of Operation with meinbergOS Web Interface

microSync systems with meinbergOS Version *2022.05.1* or later provide a feature-rich Web Interface that can be used to perform most configuration processes easily and also allows you to monitor your device's status and condition.

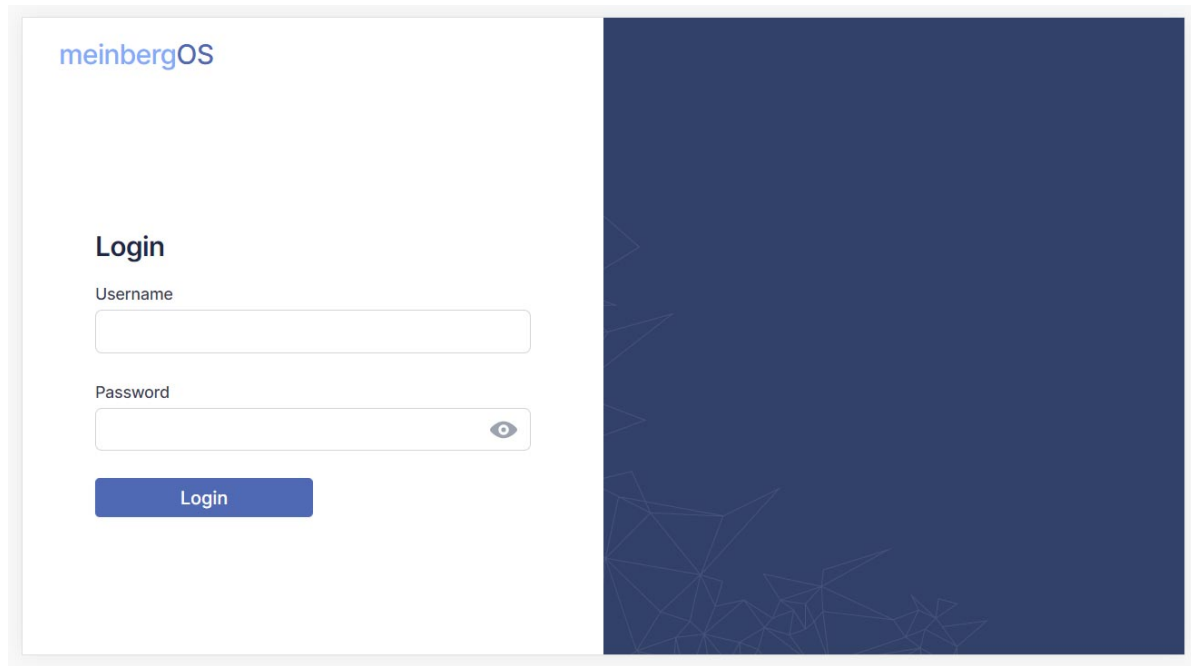

Figure 10.1: Login Page of meinbergOS Web Interface

Once you have entered the IP address of your meinbergOS device into the address bar of your web browser, the login page will appear (Figure 10.1).

The default settings are:

Username: *admin*  
Password: *timeserver*

Further information about the meinbergOS web interface in the chapter "The meinbergOS Web Interface" to be found in the microSync installation manual:

<https://www.meinberg.de/download/docs/manuals/english/microsync.pdf>



## 10.2.2 Start of Operation with Meinberg Device Manager Software

First install the Meinberg Device Manager software. After the setup, start the program. If you do not wish to install the software on your local PC, you can also download the "Portable Version" of Meinberg Device Manager and launch it directly from a portable USB storage medium.

The Meinberg Device Manager software is freely available for download from our website:

<https://www.meinbergglobal.com/english/sw/mbg-devman.htm>

A comprehensive manual of the Meinberg Device Manager software can be downloaded here:

<https://www.meinbergglobal.com/download/docs/manuals/english/meinberg-device-manager.pdf>

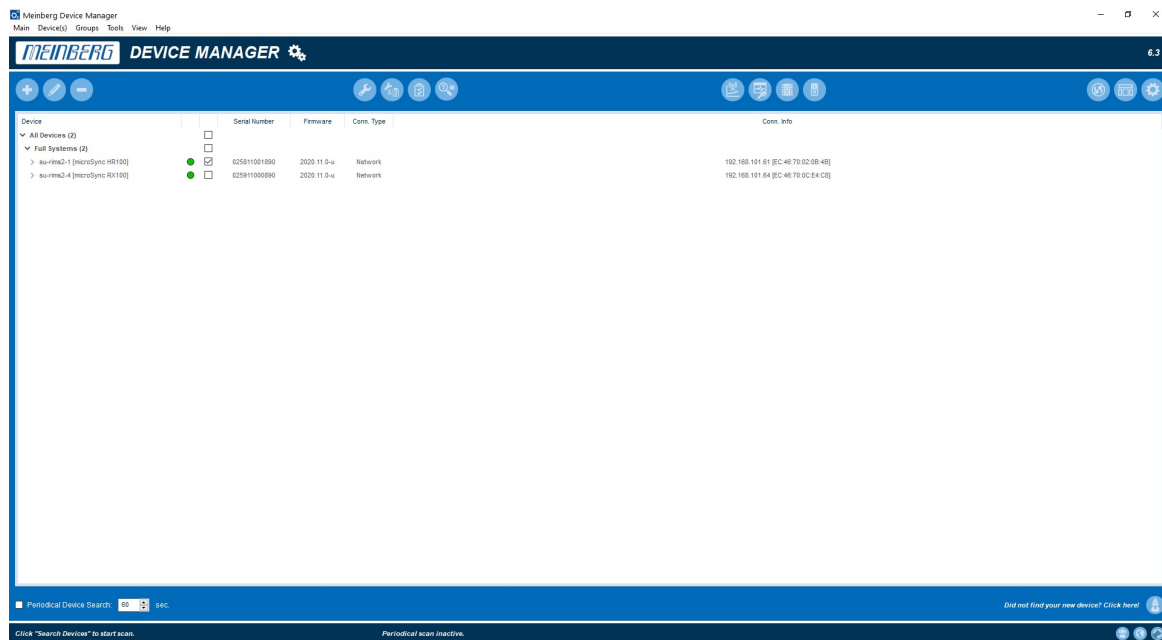

By clicking on the Search Devices button, all available microSync systems that have a serial or a network connection are recognized by the Meinberg Device Manager and will be listed then.

- Found systems are displayed with a green dot.
- Modules that are no longer recognized are displayed with a red dot.
- Modules whose password or password/user name combination is unknown will be marked with a red x.

Use the corresponding checkbox to select the device with which you want to establish a connection. With a microSync system you will then be prompted to enter your connection data. At the initial start please use **"admin"** for user and **"timeserver"** as password.



If the connected system was not found by the automatic search, a connection can be established manually by **Add Device**.

### Establishing a Network Connection

Select the connection type *Network*. Then enter the IPv4 address of the system you want to connect to.

### Authentication

Select the authentication option. The option *Username & Password* is only supported on systems with MeinbergOS.

### TCP Port

The TCP port is used to communicate with your system. Please make sure that the port is not blocked by your firewall configuration.

### Save Credentials

With this checkbox you ensure that the Device Manager has remembered the login for this system. When the program is restarted, the User and Password fields are already filled out.

### Silent Login

You have the option that the Meinberg Device Manager does not ask for a user name and password every time you log in.

### Custom Alias

Assign a custom alias for better identification of individual systems/modules in Device Manager.

### Custom Group

Assign the module/assembly to a previously created group.

# 11 Technical Appendix

## 11.1 Technical Specifications microSync Chassis

Protection Rating:	IP30
Ambient Temperature:	-20 ... 55 °C
Storage Temperature:	-30 ... 70 °C
Humidity:	5% to 95% (non-condensing) @ 40 °C
Operating Altitude:	up to 4,000 m (13,123 ft) above sea level
Atmospheric Pressure:	615 to 1,600 hPa

### Physical Dimensions:

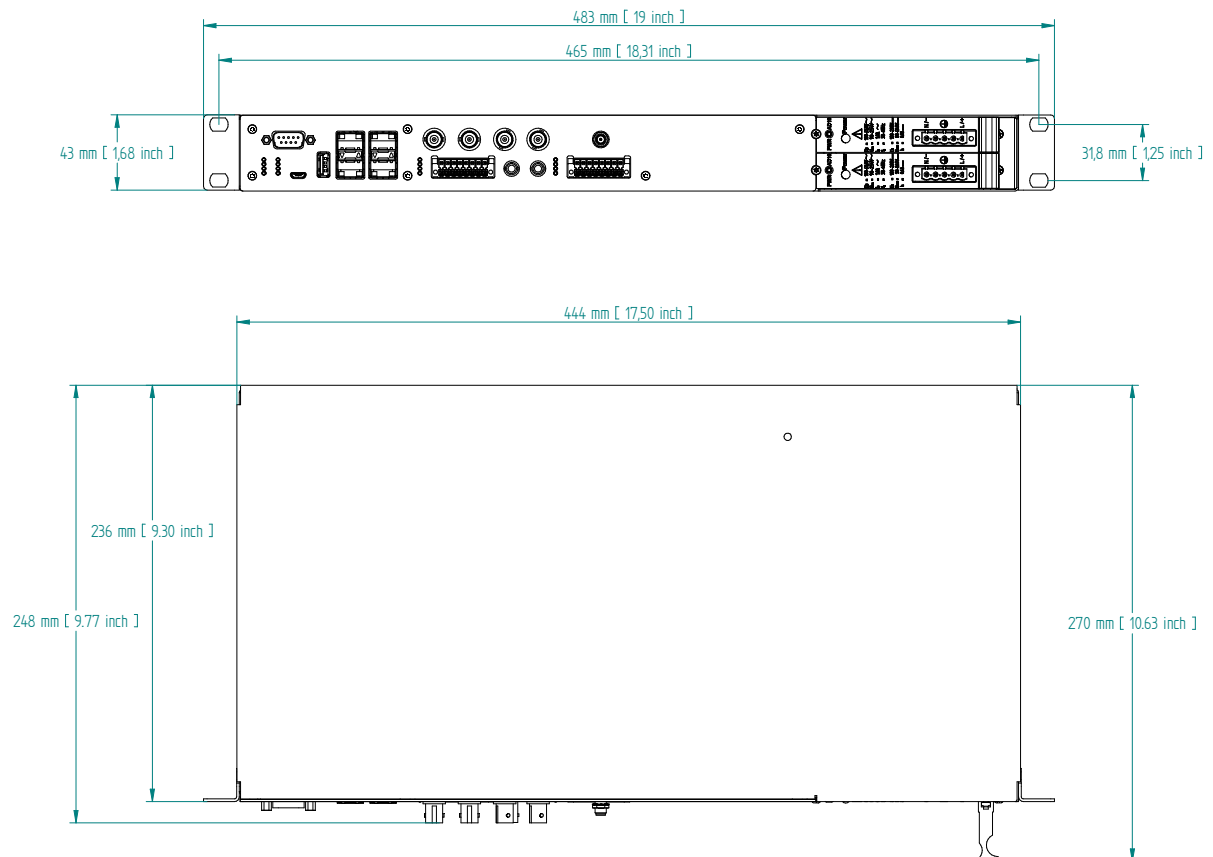

## 11.2 Technical Specifications GNSS Receiver

<b>Time to Synchronization:</b>	one minute with known receiver position and valid almanac 12 minutes if invalid battery buffered memory
<b>Pulse Outputs:</b>	HR and RX systems: eight programmable outputs (PP 1 - PP 8) <i>Timer, Single Shot, Cyclic Pulse, Pulse Per Second / Minute / Hour, DCF77 Marks, Position OK, Time Sync, All Sync, DCLS Time Code, Serial Time String, 10 MHz Frequency, Synthesizer Frequency, PTTI 1PPS</i>  DC-insulated by optocouplers $U_{CEmax} = 55 \text{ V}$ , $I_{Cmax} = 50 \text{ mA}$ , $P_{tot} = 150 \text{ mW}$ , $V_{iso} = 5000 \text{ V}$  pulse delay: $t_{on}$ e.g. $20 \mu\text{sec}$ ( $I_C = 10 \text{ mA}$ ) $t_{off}$ e.g. $3 \mu\text{sec}$ ( $I_C = 10 \text{ mA}$ )
<b>Accuracy of Pulses:</b>	after synchronization and 20 minutes of operation OCXO SQ/MQ/HQ/DHQ: better than $\pm 50 \text{ nsec}$  better than $\pm 2 \mu\text{sec}$ during the first 20 minutes of operation
<b>Frequency Outputs:</b>	10 MHz, TTL level into 50 Ohm 1 MHz, TTL level 100 kHz, TTL level
<b>Frequency Synthesizer:</b>	1/8 Hz up to 10 MHz
<b>Accuracy of Synthesizer:</b>	base accuracy depends on system accuracy 1/8 Hz to 10 kHz Phase synchron with pulse output P_SEC 10 kHz to 10 MHz frequency deviation $< 0.0047 \text{ Hz}$
<b>Synthesizer Outputs:</b>	F_SYNTH: TTL level
<b>Serial Ports:</b>	asynchronous serial port RS-232 Baud Rate: 300, 600, 1200, 2400, 4800, 9600, 19200 Baud Framing: 7E1, 7E2, 7N2, 7O1, 7O2, 8E1, 8N1, 8N2, 8O1
<b>Default Setting:</b>	COM 0: 19200, 8N1 Meinberg Standard time string, per second
<b>Time Code Outputs:</b>	Unbalanced modulated sine wave signal: $3 V_{pp}$ (MARK), $1 V_{pp}$ (SPACE) into $50 \Omega$  PWM DCLS-signal: TTL into $50 \Omega$ , active-high or -low

## GNS Receiver

<b>Type of receiver:</b>	GPS/GLONASS/Galileo/BeiDou receiver Number of channels: 72 Frequency band: GNSS L1 GPS: 1575.42 ±10 MHz GLONASS: 1602-1615 MHz Galileo: 1542.5 MHz BeiDou: 1561.09 MHz	
<b>Antenna:</b>	Combined GPS/GLONASS antenna 3 dB Bandwidth: 1590 ±30 MHz Impedance: 50 Ω Gain: 40 ±4 dB	
<b>Cable length:</b>	max. 70 m	low-loss cable (Belden H155)
<b>Antenna Connector:</b>	SMA female	
<b>Power Supply for Antenna:</b>	5 V, 100 mA – continuous short circuit protection, automatic recovery power supply via antenna cable	

## GPS Receiver

<b>Receiver:</b>	12 channel C/A code receiver with external antenna/converter unit	
<b>Antenna:</b>	antenna/converter unit with remote power supply	
<b>Cable length:</b>	max. 300 m (RG58 coax-cable)	
<b>Antenna Connector:</b>	BNC female	
<b>Power Supply for Antenna:</b>	15 V DC, continuous short circuit protection, automatic recovery isolation voltage 1000 VDC, provided via antenna cable	

## GNS-UC Receiver

<b>Type of receiver:</b>	72 channel receiver GPS/Galileo	
	Frequency band: GPS: L1C/A Galileo: E1B/C	
<b>Cable length:</b>	max. 300 m (RG58 coax-cable)	
<b>Antenna Connector:</b>	BNC female	
<b>Power Supply for Antenna:</b>	15 V DC, continuous short circuit protection, automatic recovery isolation voltage 1000 VDC, provided via antenna cable	

## 11.3 Configuration Options

### Receiver Options

RECEIVER TYPE	SIGNAL TYPE	VALUE	CONNECTOR
Meinberg GPS IF, 12-channel	IF (Meinberg Antenna))	15 V DC	BNC
Meinberg GNS-UC GPS/Galileo IF	IF (Meinberg Antenna))	15 V DC	BNC
GNSS (GPS, GLONASS, Galileo, BeiDou), 72-Channel	L1/E1/B1 Band	5 V DC	SMA

### Oscillator Options

TYP	HOLDOVER PERFORMANCE (1 DAY)	HOLDOVER PERFORMANCE (1 YEAR)
OCXO HQ	+/- 22 $\mu$ sec	+/- 788 msec
OCXO DHQ	+/- 4.5 $\mu$ sec	+/- 158 msec

## 11.4 Protocols and Profiles

NETWORK PROTOCOLS	IEEE 1588 PROFILES
IPv4, IPv6	IEEE 1588v2 Default Profile
NTPv3, NTPv4	IEEE C.37.238-2011 Power Profile
PTPv1, PTPv2	IEEE C.37.238-2017 Power Profile
IEC 62439-3 (PRP)	IEC/IEEE 61850-9-3 Power Utility Profile
DHCP, DHCPv6	Enterprise-Profile
DSCP	ITU-T G.8265.1, ITU-T G.8275.1, ITU-T G.8275.2 Telecom Profile
IEEE 802.1q VLAN Filtering/Tagging	SMPTE ST 2059-2 Broadcast Profile
IEEE 802.1p QOS	IEEE 802.1AS TSN/AVB Profile
SNMPv1/v2/v3	AES67 Media Profile
Remote Syslog Support (UDP)	DOCSIS 3.1

## 11.5 Compliances

Compliance	
CB Scheme	
CE	
FCC	
UL	
CSA	
WEEE	Waste of Electrical and Electronic Equipment
RoHS	Restriction of Hazardous Substances
REACH	Registration, Evaluation, Authorization and Restriction of Chemicals

## 12 Technical Appendix: GNSS Antennas + Accessories

### 12.1 Technical Specifications: 40 dB Multi GNSS Antenna

#### GPS L1 / GLONASS L1 / Galileo E1 / BeiDou B1 Frequency Band

GPS, GLONASS, Galileo, and BeiDou satellites do not hold a geostationary orbit, but circle the Earth once roughly every 12 hours. Satellites can only be received as long as there is nothing obstructing the line of sight between the antenna and the satellite. Detailed installation requirements can be found in the chapter **Antenna Installation**.

This active L1 antenna incorporates a high-performance antenna and low-noise amplifier in a weatherproof housing. The connected GPS/GLONASS receiver supplies the antenna with a 5.0 V DC voltage via the antenna cable.

A standard coaxial cable with 50 Ohm impedance can be used to connect the antenna to the receiver. The length of the cable between the antenna and receiver should not exceed 70 meters (H155, Low-Loss). A mounting kit is provided with the product as shipped.

Please refer to the data sheet, which can be downloaded here:

[https://www.meinbergglobal.com/download/docs/other/pctel\\_gp11gl.pdf](https://www.meinbergglobal.com/download/docs/other/pctel_gp11gl.pdf)

## 12.2 Technical Specifications: Antenna Cable

The table below shows which coaxial cable types and lengths are supported by Meinberg for each of the receiver types. If you need to purchase a replacement cable at any time, please refer to this table to ensure that you select cable with suitable cutoff frequency and attenuation properties.

Kabeltyp	RG58C/U	RG213	H2010 (Ultraflex)
Signallaufzeit bei 35 MHz (ns/100 m*)	503,6	509,61	387,45
Dämpfung bei 35 MHz (dB/100 m)	8,48	3,46	2,29
Gleichstromwiderstand (Ohm/100 m)	5,3	1,0	1,24
Kabeldurchmesser (mm)	5	10,3	7,3
max. Kabellänge (m)	300	700	1100

Please refer to the data sheet of the cable in question for further specifications.



## 12.3 Technical Specifications: MBG-S-PRO Surge Protector

Adapter plug with replaceable gas discharge tube for coaxial signal connections.

Connector Type: Type-N connector female/female. The MBG S-PRO set includes a surge protector (Phoenix CN-UB-280DC-BB), a pre-assembled coaxial cable, and a mounting bracket.

The coaxial cable surge protector must be installed on the antenna line. The shielding is grounded using a conductor that is short as possible. The CN-UB-280DC-BB is equipped with two Type-N female connectors and has no dedicated input/output polarity and no preferred installation orientation.



Phoenix CN-UB-280DC-BB

### Features:

- High RF Performance
- Multiple Strike Capability
- 20 kA Surge Protection
- Bidirectional Protection

<b>Installation Method:</b>	Connector Type-Specific Adapter Plug	
<b>Direction of Action:</b>	Line Shield/Earth Ground	
<b>Maximum Continuous Operating Voltage:</b>	UC (Wire-Ground) 195 V AC	280 V DC
<b>Rated Current:</b>	$I_N$	5 A (25 °C)
<b>Effective Operating Current:</b>	$I_C$ at UC	$\leq 1 \mu\text{A}$
<b>Rated Discharge Current:</b>	$I_n$ (8/20) $\mu\text{s}$ (Core-Earth) $I_n$ (8/20) $\mu\text{s}$ (Core-Shield)	20 kA 20 kA
<b>Total Surge Current:</b>	(8/20) $\mu\text{s}$ (10/350) $\mu\text{s}$	20 kA 2.5 kA

<b>Max. Discharge Current:</b>	$I_{\max} (8/20)\mu s$ Maximum (Core-Shield)	20 kA
<b>Rated Pulse Current:</b>	$I_{\text{an}} (10/1000)\mu s$ (Core-Shield)	100 A
<b>Impulse Discharge Current:</b>	$(10/350) \mu s$ , Peak Value $I_{\text{imp}}$	2.5 kA
<b>Output Voltage Limit:</b>	At 1 kV/ $\mu s$ (Core-Earth) spike At 1 kV/ $\mu s$ (Core-Earth) spike	$\leq 900$ V $\leq 900$ V
<b>Response Time:</b>	tA (Core-Earth) tA (Core-GND)	$\leq 100$ ns $\leq 100$ ns
<b>Input Attenuation:</b>	aE, asym.	Typically 0.1 dB ( $\leq 1.2$ GHz) Typically 0.2 dB ( $\leq 2.2$ GHz)
<b>Cut-Off Frequency:</b>	$f_g$ (3 dB), asym. (Shield) in 50 $\Omega$ System	$> 3$ GHz
<b>Standing Wave Ratio:</b>	VSWR in a 50 $\Omega$ System	Typically 1.1 ( $\leq 2$ GHz)
<b>Permissible HF Power:</b>	$P_{\max}$ at VSWR = xx (50 $\Omega$ System)	700 W (VSWR = 1.1) 200 W (VSWR = $\infty$ )
<b>Capacitance:</b>	(Core-Earth) Asymmetric (Shield)	Typically 1.5 pF Typically 1.5 pF
<b>Surge Current Resistance:</b>	(Core-Earth)	C1 - 1 kV/500 A C2 - 10 kV/5 kA C3 - 100 A D1 - 2.5 kA
<b>Ambient Temperature:</b>	(During Operation)	-40 °C ... 80 °C
<b>Supported Altitude:</b>		$\leq 2000$ m (above sea level)
<b>IP Rating:</b>		IP55
<b>Housing Material:</b>		Nickel-Plated Brass Colored Nickel
<b>Dimensions:</b>		Height 25 mm, Width 25 mm, Depth 67 mm
<b>Connection Type:</b>	IN OUT	Type-N Connector 50 $\Omega$ Type-N Connector, Female Type-N Connector, Female
<b>Standards/Regulations:</b>		IEC 61643-21 2000 + A1:2008 EN 61643-21 2001 + A1:2009

The original product page of the supplier (see link) of the CN-UB-280DC-BB surge protector is the source of the specifications above. Please refer to the manufacturer's product page at the following link for detailed specifications as well as a variety of product-specific documents:

<https://www.phoenixcontact.com/online/portal/gb/?uri=pxc-oc-itemdetail:pid=2818850>

### 12.3.1 MBG S-PRO: Physical Dimensions

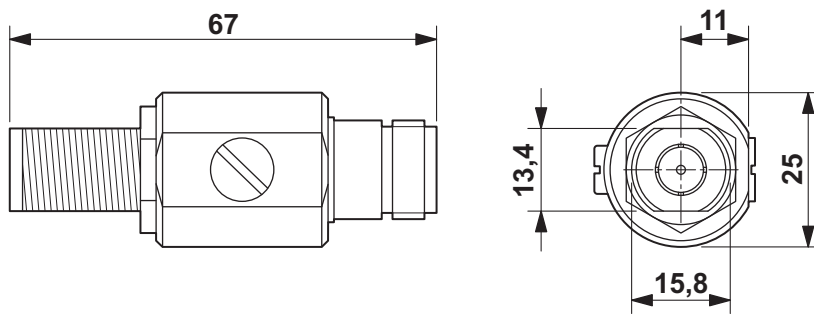

### 12.3.2 Installation and Grounding

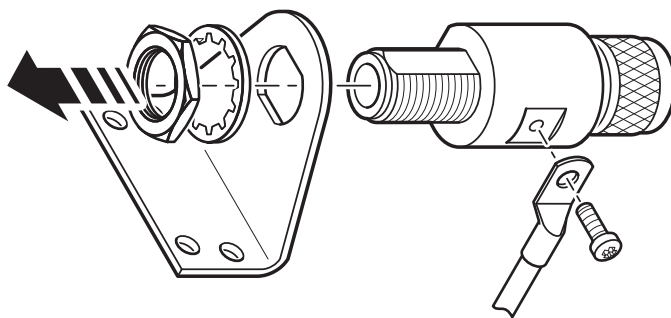

## 12.4 Technical Specifications: RV-76G GPS/GLONASS Antenna for Mobile Applications

### General Information

The antenna system RV-76G is the integration of a high performance GPS/GLONASS patch antenna and a state-of-the-art low-noise amplifier into a very low-profile, extremely compact and fully waterproof antenna signal enclosure. When connected to a GPS/GLONASS receiver with +2.5 to 5 V DC antenna power, it provides excellent signal amplification and out-of-band rejection for that receiver.

The flat design and the robustness of the enclosure make the RV-76G one of the most popular antennas in the vehicle navigation and marine market.

### Specifications

#### Physical Characteristics

Construction:	Polycarbonate radome with detachable cable/connector for easy mounting, rubber O-ring between top radome and screw base for waterproofing.
Dimensions:	60 mm diameter x 38 mm height
Weight:	125 g (excluding cable and connector)
Color:	Standard ivory white
Mounting:	Bulkhead mount with 0.8-inch threaded wing nut

#### Antenna Element

Center Frequency:	1575.42 MHz $\pm$ 10 MHz & 1602 MHz $\pm$ 8 MHz
Polarization:	R.H.C.P. (Right Hand Circular Polarization)
Gain at Zenith:	+1.5 dBic typ.
Axial Ratio:	3 dB max. <i>mounted on the 70 mm x 70 mm square ground plane</i>

#### Low Noise Amplifier

Gain:	27 dB @ 3 V typ.
Band Width:	43 MHz min. @ 511 $\leq$ -10 dB
Noise Figure:	1.5 typ.
Supply Voltage:	+2.5 ~5 V DC
Current Draw:	3 V DC: 10.6 mA typ. / 5.0 V DC: 21 mA typ.
Impedance:	50 Ohm

#### Cable & Connector

RF Cable:	5 m RG174/U (Standard)
Tensile Strength:	6 kg (13 lbs) @ 5 sec. with molded plastics on connector for strain relief

**Overall Performance** (Antenna Element, LNA & Cable)

Center Frequency: 1575.42 MHz  $\pm$  10 MHz & 1602 MHz  $\pm$  8 MHz

Gain: At 90°, 27  $\pm$  3dB (Cable Loss)  
*Note: When mounted on the 70 mm x 70 mm square base plate*

**Environmental Conditions**

Operating Temperature: ~40°C +85°C

Storage Temperature: ~40°C +90°C

Relative Humidity: 95% non-condensing

*Source: Datasheet gps-glonass\_antenna\_rv-76g\_catalog\_v1.pdf (Sanav)*  
[https://www.meinberg.de/download/docs/other/rv-76g\\_en.pdf](https://www.meinberg.de/download/docs/other/rv-76g_en.pdf)

## 13 RoHS Conformity

### Conformity with EU Directive 2011/65/EU (RoHS)

We hereby declare that this product is compliant with the European Union Directive 2011/65/EU and its delegated directive 2015/863/EU "Restrictions of Hazardous Substances in Electrical and Electronic Equipment" and that no impermissible substances are present in our products pursuant to these Directives.

We warrant that our electrical and electronic products sold in the EU do not contain lead, cadmium, mercury, hexavalent chromium, polybrominated biphenyls (PBBs), polybrominated diphenyl ethers (PBDEs), bis(2-ethylhexyl)phthalat (DEHP), benzyl butyl phthalate (BBP), dibutyl phthalate (DBP), or diisobutyl phthalate (DIBP) above the legal limits.



# 14 Declaration of Conformity for Operation in the European Union

## EU-Konformitätserklärung

Doc ID: microSync RX800/AD10DC20-December 1, 2023

**Hersteller**  
*Manufacturer* Meinberg Funkuhren GmbH & Co. KG  
Lange Wand 9, D-31812 Bad Pyrmont

erklärt in alleiniger Verantwortung, dass das Produkt,  
*declares under its sole responsibility, that the product*

**Produktbezeichnung**  
*Product Designation* microSync RX800/AD10DC20

auf das sich diese Erklärung bezieht, mit den folgenden Normen und Richtlinien übereinstimmt:  
*to which this declaration relates is in conformity with the following standards and provisions of the directives:*

---

RED – Richtlinie <i>RED Directive</i> 2014/53/EU	ETSI EN 303 413 V1.2.1 (2021-04)
EMV – Richtlinie <i>EMC Directive</i> 2014/30/EU	ETSI EN 301 489-1 V2.2.3 (2019-11) ETSI EN 301 489-19 V2.2.1 (2022-09) DIN EN IEC 61000-6-2:2019 DIN EN IEC 61000-6-3:2021 DIN EN 55032:2015/AC:2016/A11:2020/A1:2020 DIN EN 55035:2017/A11:2020
Niederspannungsrichtlinie <i>Low Voltage Directive</i> 2014/35/EU	DIN EN IEC 62368-1:2020/A11:2020
RoHS – Richtlinie <i>RoHS Directive</i> 2011/65/EU + 2015/863/EU	DIN EN IEC 63000:2018

---

Bad Pyrmont, den December 1, 2023

  
Stephan Meinberg  
Production Manager

# 15 Declaration of Conformity for Operation in the United Kingdom

## UK Declaration of Conformity

Doc ID: microSync RX800/AD10DC20-December 1, 2023

**Manufacturer**    Meinberg Funkuhren GmbH & Co. KG  
Lange Wand 9  
31812 Bad Pyrmont  
Germany

*declares that the product*

**Product Designation**    microSync RX800/AD10DC20

*to which this declaration relates, is in conformity with the following standards and provisions of the following regulations under British law:*

Radio Equipment Regulations 2017 (as amended) <i>SI 2017/1206</i>	ETSI EN 303 413 V1.2.1 (2021-04)
Electromagnetic Compatibility Regulations 2016 (as amended) <i>SI 2016/1091</i>	ETSI EN 301 489-1 V2.2.3 (2019-11) ETSI EN 301 489-19 V2.2.1 (2022-09) EN IEC 61000-6-2:2019 EN IEC 61000-6-3:2021 EN 55032:2015/AC:2016/A11:2020/A1:2020 EN 55035:2017/A11:2020
Electrical Equipment (Safety) Regulations 2016 (as amended) <i>SI 2016/1101</i>	EN IEC 62368-1:2020/A11:2020
The Restriction of the Use of Certain Hazardous Substances in Electrical and Electronic Equipment Regulations 2012 (as amended) <i>SI 2012/3032</i>	EN IEC 63000:2018

Bad Pyrmont, Germany, dated December 1, 2023

  
 Stephan Meinberg  
 Production Manager