



The Synchronization Experts.



TECHNICAL REFERENCE

LANTIME

M900/GPS/LNE/RPS/BGT

October 27, 2022

Meinberg Funkuhren GmbH & Co. KG

Table of Contents

1	Imprint	1
2	Important Safety Information	2
2.1	Important Safety Information and Safety Precautions	2
2.2	Used Symbols	3
2.3	Product Documentation	4
2.4	Safety during Installation	5
2.5	Connection of Protective Earth Conductor/Grounding	8
2.6	Safety During Operation	9
2.7	Safety during Maintenance	10
2.8	Handling of Batteries	11
2.9	Cleaning and Care	12
2.10	Prevention of ESD Damage	12
2.11	Return of Electrical and Electronic Equipment	13
3	General Information about LANTIME	14
4	Technical specifications 3U Chassis	15
5	LANTIME M900 Front Connectors	17
5.1	LNE-GE: Additional ethernet ports for LANTIME time servers	20
5.2	GPS Receiver	21
6	LANTIME M900 Rear Connectors	23
6.1	Power Connector	24
6.2	RS-232 COMx Timestring	25
6.3	Error Relay	26
6.4	Pulses Outputs	27
6.5	10 MHz Frequency Output	27
6.6	Pulse per Second Output	27
6.7	Antenna Input: GPS Reference Clock	28
7	Installation of a GPS Antenna	29
8	Technical Appendix: GPS Antenna + Accessories	34
8.1	Technical Specifications: Antenna Cable	36
8.2	Antenna Short Circuit	36
8.3	Technical Specifications: MBG S-PRO Surge Protector	37
8.3.1	MBG S-PRO: Physical Dimensions	39
8.3.2	Installation and Grounding	39
9	RoHS and WEEE	40
10	Declaration of Conformity	41

1 Imprint

Meinberg Funkuhren GmbH & Co. KG
Lange Wand 9, 31812 Bad Pyrmont, Germany

Phone: + 49 (0) 52 81 / 93 09 - 0

Fax: + 49 (0) 52 81 / 93 09 - 230

Website: <https://www.meinbergglobal.com>

Email: info@meinberg.de

Date: January 12, 2021

2 Important Safety Information

2.1 Important Safety Information and Safety Precautions

The following safety information must be observed whenever the device is being installed or operated. Failure to observe this safety information and other special warnings or operating instructions in the product manuals constitutes improper usage and may violate safety standards and the manufacturer's requirements.



Depending on the configuration of your device or installed options, some information may not specifically apply to your device.



The device satisfies the requirements of the following EU regulations: EMC Directive, Low Voltage Directive, RoHS Directive and—where applicable—the Radio Equipment Directive.

If a procedure is marked with the following signal words, you may only proceed with it if you have understood and fulfilled all requirements. Hazard notices and other relevant information are classified and indicated as such in this manual according to the following system:



DANGER!

This signal word indicates a hazard with a high risk level. Such a notice refers to a procedure or other action that will very likely result in serious injury or even death if not observed or if improperly performed.



WARNING!

This signal indicates a hazard with a medium risk level. Such a notice refers to a procedure or other action that may result in serious injury or even death if not observed or if improperly performed.



CAUTION!

This signal word indicates a hazard with a low risk level. Such a notice refers to a procedure or other action that may result in minor injury if not observed or if improperly performed.















ATTENTION!

This signal word refers to a procedure or other action that may result in product damage or the loss of important data if not observed or if improperly performed.

2.2 Used Symbols

The following symbols and pictograms are used in this manual. Pictograms are used in particular to indicate potential hazards in all hazard categories.

Symbol	Beschreibung / Description
	IEC 60417-5031 Gleichstrom / <i>Direct current</i>
	IEC 60417-5032 Wechselstrom / <i>Alternating current</i>
	IEC 60417-5017 Erdungsanschluss / <i>Earth (ground) terminal</i>
	IEC 60417-5019 Schutzleiteranschluss / <i>Protective earth (ground) terminal</i>
	ISO 7000-0434A Vorsicht / <i>Caution</i>
	IEC 60417-6042 Vorsicht, Risiko eines elektrischen Schlages / <i>Caution, risk of electric shock</i>
	IEC 60417-5041 Vorsicht, heiße Oberfläche / <i>Caution, hot surface</i>
	IEC 60417-6056 Vorsicht, Gefährlich sich bewegende Teile / <i>Caution, moving parts</i>
	IEC 60417-6172 Trennen Sie alle Netzstecker / <i>Disconnect all power connectors</i>
	IEC 60417-5134 Elektrostatisch gefährdete Bauteile / <i>Electrostatic Discharge Sensitive Devices</i>
	IEC 60417-6222 Information generell / <i>General information</i>
 	2012/19/EU Dieses Produkt fällt unter die B2B Kategorie. Zur Entsorgung muss es an den Hersteller übergeben werden. <i>This product is handled as a B2B-category product. To ensure that the product is disposed of in a WEEE-compliant fashion, it must be returned to the manufacturer.</i>

2.3 Product Documentation

Detailed product documentation is provided on a USB flash drive delivered with the Meinberg system. The manuals can also be downloaded from the Meinberg website at <https://www.meinbergglobal.com>, where you can enter your system name into the search box at the top of the page to find the relevant manual. Alternatively, contact Meinberg Support for further assistance.

The "Docs & Support" menu on the Web Interface also provides user manuals for time server administrators.



This manual contains important safety instructions for the installation and operation of the device. Please read this manual thoroughly before using the device.

This device may only be used for the purpose described in this manual. In particular, the specified operating limits of the device must be heeded. The person setting up the device is responsible for safety matters in relation to any larger system in which the device is installed!

Failure to observe these instructions may have an adverse impact on device safety!

Please keep this manual in a safe place.

Target Readership

This manual is only intended to be used by qualified electricians, or by persons who have been appropriately instructed by a qualified electrician and who are familiar with applicable national standards and with safety rules & regulations. This device may only be installed, set up, and operated by qualified personnel.

2.4 Safety during Installation



WARNING!

Pre-Operation Procedures and Preparation for Use

This mountable device has been designed and examined in accordance with the requirements of the standard IEC 62368-1 "Audio/Video, Information and Communication Technology Equipment - Part 1: Safety Requirements".

When the mountable device is to be used as part of a larger unit (e.g., electrical enclosure), there will be additional requirements in the IEC 62368-1 standard that must be observed and complied with. General requirements regarding the safety of electrical equipment (such as IEC, VDE, DIN, ANSI) and applicable national standards must be observed in particular.

The device has been developed for use in the industrial sector or in home environments and may only be used in such environments. In environments at risk of high environmental conductivity ("high pollution degree" according to IEC 60664-1), additional measures such as installation of the device in an air-conditioned electrical cabinet may be necessary.

Transport, Unpacking, Installation

If the unit has been brought into the usage area from a cold environment, condensation may develop; in this case, wait until the unit has adjusted to the temperature and is completely dry before setting it up.

When unpacking & setting up, and before operating the equipment, be sure to read the information on installing the hardware and the specifications of the device. These include, for example, dimensions, electrical characteristics, or necessary environmental conditions.

Fire safety standards must be upheld with the device in its installed state.

The device must not be damaged in any way when mounting it. In particular, holes must not be drilled into the housing.

For safety reasons, the device with the highest mass should be installed at the lowest position in the rack. Further devices should be installed from the bottom, working your way up.

The device must be protected against mechanical & physical stresses such as vibration or shock.



Connecting Data Cables

Do not connect or disconnect data cables during a thunderstorm, as doing so presents a risk in the event of a lightning strike.

The device cables must be connected or disconnected in the order specified in the user documentation for the device. Cables should always be held by the connector body when connecting or disconnecting them. Never pull a connector out by pulling on the cable. Doing so may cause the plug to be detached from the cable or cause damage to the plug itself.

Cables must be installed so that they do not represent a health & safety hazard (e.g., tripping) and are not at risk of damage (e.g., kinks).

Connecting the Power Supply

This equipment is operated at a hazardous voltage. Failure to observe the safety instructions in this manual may result in serious injury, death or property damage.

Before the device is connected to the power supply, a grounding conductor must be connected to the earth terminal of the device.

The power supply should be connected with a short, low-inductance cable.

Before operation, check that all cables and lines work properly and are undamaged. Ensure in particular that the cables do not have kinks, that they are not wound too tightly around corners, and that no objects are placed on the cables.

Ensure that all connections are secure—make sure that the lock screws of the power supply plug are tightened when using a 3-pin MSTB or 5-pin MSTB connector (see diagram, LANTIME M300 power supply).

5-Pin MSTB Connector

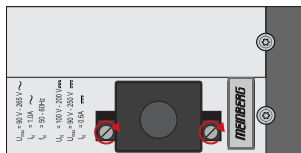

3-Pin MSTB Connector

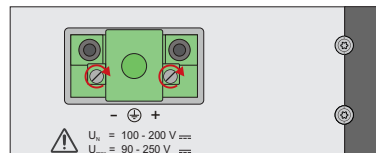

Faulty shielding or cabling and improperly connected plugs are a health & safety risk (risk of injury or death due to electrical shock) and may damage or even destroy your Meinberg device or other equipment.

Ensure that all necessary safety precautions have been taken. Connect all cables to the device only while the device is de-energized before turning on the power. Observe the safety instructions on the device itself (see safety symbols).

The metal chassis of the device is grounded. When installing the device in an electrical enclosure, it must be ensured that adequate clearance is provided, creepage distances to adjacent conductors are maintained, and that there is no risk of short circuits.

In the event of a malfunction or if servicing is required (e.g., damage to the chassis or power cable, ingress of fluids or foreign objects), the power supply may be cut off.

Please address any questions regarding your building's electrical, cable or antenna installations to the person or department responsible for that installation within your building.

AC Power Supply	DC Power Supply
<ul style="list-style-type: none"> • The device is a Protection Class 1 device and may only be connected to a grounded outlet (TN system). • For safe operation, the installation must be protected by a fuse of a rating not exceeding 16 A and equipped with a residual-current circuit breaker in accordance with applicable national standards. • The disconnection of the appliance from the mains power supply must always be performed from the mains socket and not from the appliance itself. • Mains-powered appliances are equipped with a safety-tested mains cable designed for use in the country of operation and may only be connected to a grounded shockproof socket, otherwise electric shock may occur. • Make sure that the mains socket on the appliance or the mains socket of the house installation is readily accessible for the user so that the mains cable can be pulled out of the socket in an emergency. 	<ul style="list-style-type: none"> • In accordance with IEC 62368-1, it must be possible to disconnect the appliance from the supply voltage from a point other than the appliance itself (e.g., from the primary circuit breaker). • The power supply plug may only be fitted or dismantled while the appliance is isolated from the power supply (e.g., disconnected at the primary circuit breaker). • Supply cables must be adequately secured and have an adequate wire gauge size. <p style="text-align: center;"><i>Connection Cable Wire Gauge:</i> $1\text{ mm}^2 - 2.5\text{ mm}^2$ 17 AWG – 13 AWG</p> <ul style="list-style-type: none"> • The power supply of the device must have a suitable disconnection mechanism such as a switch. This disconnection mechanism must be readily accessible in the vicinity of the appliance and marked accordingly as a cut-off mechanism for the appliance.

2.5 Connection of Protective Earth Conductor/Grounding



ATTENTION!



In order to ensure that the device can be operated safely and to meet the requirements of IEC 62368-1, the device must be correctly connected to the protective earth conductor via the protective earth connection terminal.



If an external ground connection is provided on the housing, it must be connected to the grounding busbar (earthing busbar) for safety reasons before connecting the power supply. Like this, any possible leakage current on the housing is safely discharged to earth.

The screw, washer and toothed lock washer necessary for mounting the grounding cable are located at the grounding point of the housing. A grounding cable is not included in the contents of delivery.

Note:

Please use a grounding cable with cross-section $\geq 1.5 \text{ mm}^2$, as well as a suitable grounding clamp/lug. Always ensure that the connection is properly crimped!

2.6 Safety During Operation



WARNING!

Avoiding Short-Circuits

Protect the device against all ingress of solid objects or liquids. Ingress presents a risk of electric shock or short-circuiting!

Ventilation Slots

Ensure that ventilation slots are clean and uncovered at all times. Blocked ventilation slots may cause heat to be trapped in the system, resulting in overheating. This may cause your device to malfunction or fail.

Appropriate Usage

The device is only deemed to be appropriately used and EMC limits (electromagnetic compatibility) are only deemed to be observed if the chassis cover is properly fitted (thus ensuring that the device is properly cooled, fire-safe, and shielded against electrical, magnetic and electromagnetic fields).



Switching the Device Off in the Event of a Malfunction or when Repairs are Required

It is not sufficient to simply switch off the device itself in order to disconnect the power supply. If the device is malfunctioning, or if repairs become necessary, the device must be isolated from all power supplies immediately.

To do so, follow the procedure below:

- Switch off the device from the unit itself.
- Pull out all power supply plugs.
- Inform the person or department responsible for your electrical installation.
- If your device is connected to an Uninterruptible Power Supply (UPS), it will remain operational even after pulling the UPS power cable from the mains socket. In this case, you will need to shut down your UPS in accordance with the user documentation of your UPS system.

2.7 Safety during Maintenance



WARNING!

The device must never be opened. Repairs to the device may only be performed by the manufacturer or by authorized personnel. Improper repairs may expose the user to considerable safety risks (electric shock, fire hazard).

Opening the device or individual device components in an unauthorized fashion may also expose the user to considerable risks and invalidate your warranty. Meinberg Funkuhren accepts no liability for consequences arising from such unauthorized actions.



Danger from moving parts—do not touch moving parts.



Parts of the device may become very hot during operation. Do not touch these surfaces! If necessary, switch off the device before installing or removing any equipment, and allow it to cool down.

2.8 Handling of Batteries



WARNING!

The lithium battery on the receiver modules has a life of at least ten years. Should it be necessary to replace it, please note the following:

Improper handling of the battery can lead to an explosion or to a leakage of flammable liquids or gases.

- Never short-circuit the battery.
- Never attempt to recharge the battery.
- Never throw the battery into a fire.
- The battery must only be exposed to the barometric pressure range specified by the battery manufacturer.
- The battery must only ever be replaced with one of the same type or a comparable type recommended by the manufacturer. The battery must only be replaced by the manufacturer or an authorized technician.
- Never dispose of the battery in a mechanical crusher or shredder, or in an open fire or furnace.

Please consult your local waste disposal regulations for information on how to dispose of hazardous waste.



IMPORTANT!

The battery is used to power components such as the RAM and the reserve real-time backup clock for the reference clock.

If the battery voltage drops below 3 V DC, Meinberg recommends having the battery replaced. If the battery voltage drops below the specified minimum, the following behavior may be observed in the reference clock:

- The reference clock may have the wrong date or wrong date upon power-up
- The reference clock repeatedly starts in Cold Boot mode
- Some of the configurations saved for the reference clock may be lost

2.9 Cleaning and Care



ATTENTION!

Never clean the device using liquids! Water ingress is a significant safety risk for the user (e.g., electric shock).

Liquids can cause irreparable damage to the electronics of the device! The ingress of liquids into the device chassis may cause short circuits in the electronic circuitry.

Only clean with a soft, dry cloth. Never use solvents or cleaners.

2.10 Prevention of ESD Damage



ATTENTION!

An ESDS device (electrostatic discharge-sensitive device) is any device at risk of damage or malfunction due to electrostatic discharges (ESD) and thus requires special measures to prevent such damage or malfunction. Systems and modules with ESDS devices usually bear the following symbol:



Symbol Indicating Devices with ESDS Components

The following measures will help to protect ESDS components from damage and malfunction.

When preparing to dismantle or install devices:

Ground your body (for example, by touching a grounded object) before touching sensitive devices.

Ensure that you wear a grounding strap on your wrist when handling such devices. These straps must in turn be attached to an uncoated, non-conductive metal part of the system.

Use only tools and devices that are free of static electricity.

When transporting devices:

Devices must only be touched or held by the edges. Never touch any pins or conductors on the device.

When dismantling or installing devices:

Avoid coming into contact with persons who are not grounded. Such contact may compromise your connection with the earth conductor and thus also compromise the device's protection from any static charges you may be carrying.

When storing devices:

Always store devices in ESD-proof ("antistatic") bags. These bags must not be damaged in any way. ESD-proof bags that are crumpled or have holes cannot provide effective protection against electrostatic discharges.

ESD-proof bags must have a sufficient electrical resistance and must not be made of conductive metals if the device has a lithium battery fitted on it.

2.11 Return of Electrical and Electronic Equipment



ATTENTION!

WEEE Directive on Waste Electrical and Electronic Equipment 2012/19/EU
(WEEE Waste Electrical and Electronic Equipment)

Waste Separation

Product Category: According to the device types listed in Annex I of the WEEE Directive, this product is classified as "IT and Telecommunications Equipment".



This product satisfies the labeling requirements of the WEEE Directive. The product symbol on the left indicates that this electronic product must not be disposed of in domestic waste.

Return and Collection Systems

When disposing of your old equipment, please use the national return or collection systems available to you. Alternatively, you may contact Meinberg, who will provide further assistance.

The return of electronic waste may not be accepted if the device is soiled or contaminated in such a way that it potentially presents a risk to human health or safety.

Return of Used Batteries

The EU Battery Directive prohibits the disposal of batteries marked with the WEEE trashcan symbol above in household waste.

3 General Information about LANTIME

LANTIME stands for Local Area Network **T**ime Server. The LANTIME provides an absolute and highly precise time reference in a TCP/IP network (stratum 1 server). The time is made available to all NTP clients via the NTP protocol (Network Time Protocol) and allows easy integration of an absolute time reference into an existing network.

The individual LANTIME variants differ mainly in the time reference source used. An external radio clock, a built-in GPS, GNSS (GPS, GLONASS, Galileo, BeiDou), or GNS-UC (only GPS and Galileo) satellite receiver, an IRIG time code receiver, a long-wave radio receiver (DCF77, MSF, WWVB), external NTP servers, or a hybrid DCF77/GNSS receiver system can be used as a time reference source. A GNSS-synchronized LANTIME, for example, consists of a GNSS satellite receiver, a single-board computer with an integrated network card, and a power supply unit.

A simplified LINUX operating system is implemented on the single-board computer and is loaded from a flash disk during the boot phase. All settings can be made using eight pushbuttons and a display*. The time server can also be remotely configured via network over SSH, FTP, or Telnet. An integrated web server provides access to the LANTIME via any standard web browser.

* LANTIME M100 time servers do not have a display or function keys. Instead, these systems are configured and monitored via the LANTIME Web Interface, SSH, Telnet, or FTP.

4 Technical specifications 3U Chassis

Housing Chassis 19" / 3U

Housing material Aluminium

Temperature range

Operation 0 ... 50 °C (32 ... 122 °F)

Storage -20 ... 70 °C (-4 ... 158 °F)

Relative humidity

Operation 85 % max. (non-condensing)

Operation height

Operation 2000 m / 6562 ft (above sea level)

Acoustics 0 dB (A)

IP protection class IP20

Housing dimensions

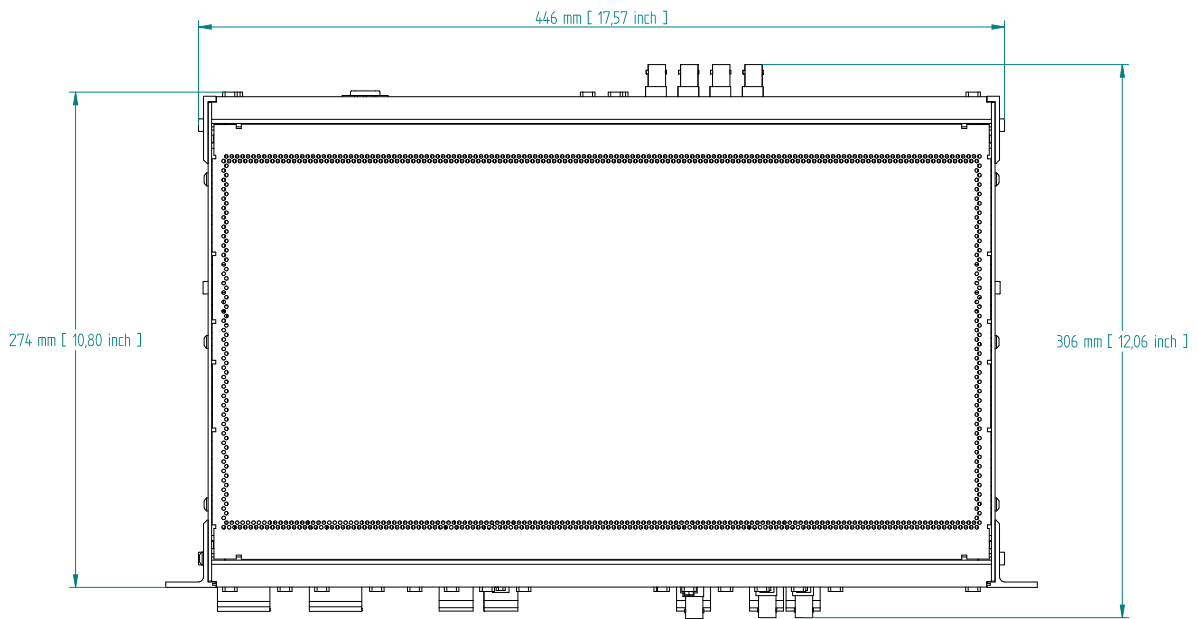
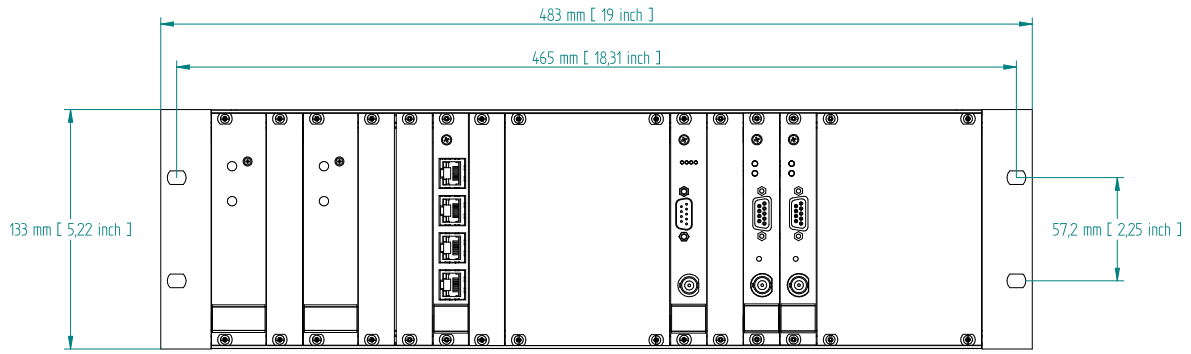

5 LANTIME M900 Front Connectors

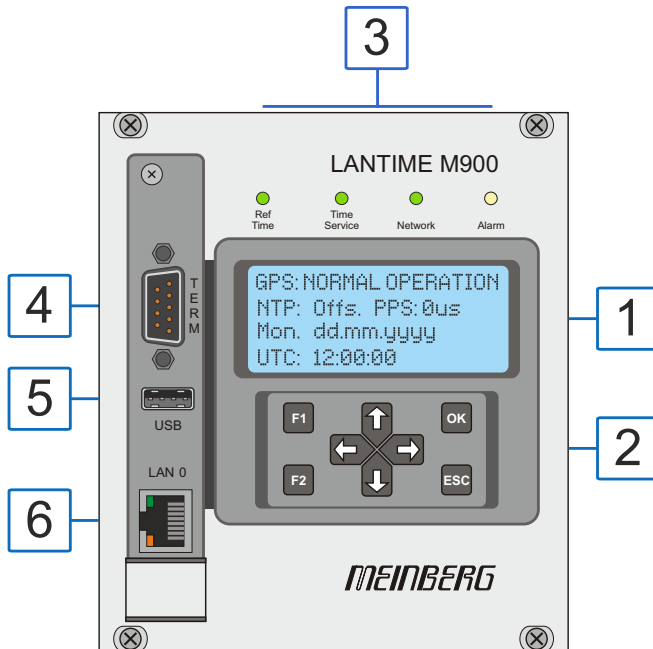

1. The main menu is displayed after switching on the device and having completed the initialization phase. In the main menu the most important status information are displayed. In the top line of the display the operating mode of the reference clock / reference time is shown. Instead of "GPS: NORMAL OPERATION" the messages, "GPS: COLD BOOT", "GPS: WARM BOOT" or "GPS: UPDATE ALMANAC" can appear. In case the antenna connection is interrupted, the following message is shown: "GPS: ANTENNA FAULTY".

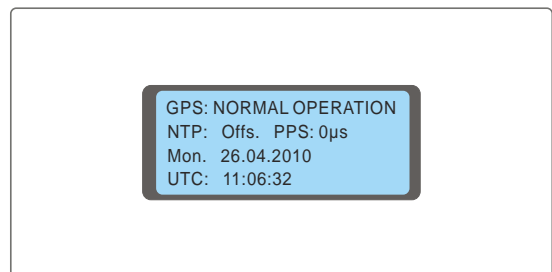

2. By using the 4 arrows and the "ESC", "F1" and "F2" buttons of the keypad you can navigate through each menu in the display. You can always return to the main menu by pressing the "ESC" button several times.

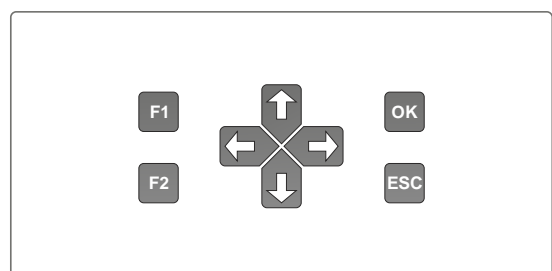

3.

"Ref. Time"

- green: the reference clock (e.g. build-in GPS) provides a valid time
- red: the reference clock does not provide a valid time

"Time Service"

- green: NTP is synchronized to the reference clock, e.g. GPS
- red: NTP is not synchronized or switched to the "local clock"

"Network"

- green: all monitored network interfaces are connected ("Link up")
- red: at least one of the monitored network interfaces is faulty

"Alarm"

- off: no error
- red: general error

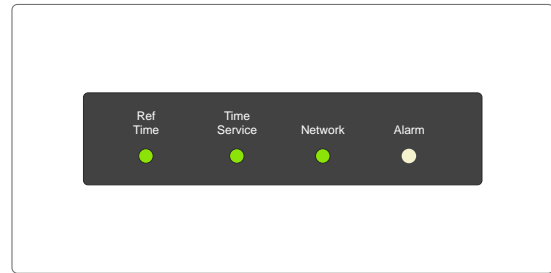

4.

To connect a serial terminal use the 9 pin SUBD RS-232 connector in the front panel. Via the serial terminal connection it is possible to configure the parameters with a terminal program. To establish a connection between the LANTIME and a PC, use a NULL-MODEM cable. Configure your terminal program with 38400 Baud, 8 Databits, no parity and one Stopbit (8N1). The terminal emulation has to be set to VT100. After connecting to the time server the login message will be displayed. Enter user name and password:

Default User: *root*; Password: *timeserver*

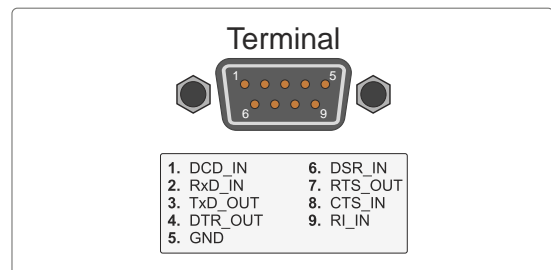

5.

All devices of the LANTIME M-Series dispose a USB interface, which can be used to plug in a USB Stick. The USB Stick can be deployed for the following tasks:

- to lock the keys on the LC-Display, to prevent unauthorized access
- to save the LANTIME configuration
- to transfer the configuration between several LANTIMES
- to save log files

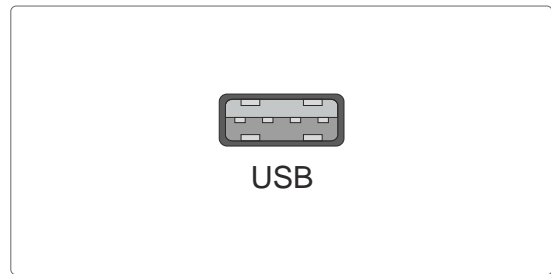

6.

Link speed: 10/100 MBit

Connector Type: 8P8C (RJ45)

Cable: CAT 5.0

Duplex Modes: Half/Full/Autonegotiaton

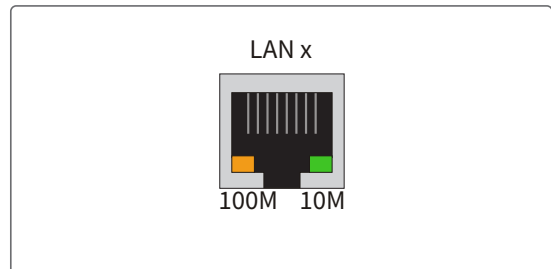

5.1 LNE-GE: Additional ethernet ports for LANTIME time servers

Description

The module LNE-GE extends a LANTIME NTP time server (3U models) with additional network connections.

The additional ports can be used to provide time synchronization to additional separate networks or - by using a feature called "bonding" - to configure redundant network connections (note: the involved active network components like switches have to support this).

There are 7 modes available:

- Autosensing
- 10 MBit/Halb-Duplex
- 100 MBit/Halb-Duplex
- 1000 MBit/Halb-Duplex
- 10MBit/Voll-Duplex
- 100 MBit/Voll-Duplex
- 1000 MBit/Voll-Duplex

Configuration can be done via display menu or web interface.

Key Features

- Four additional 10/100/1000MBit network ports
- Status LEDs: Connect, Activity, Speed
- RJ45 network connectors at the front panel

1000Base-T Network Port

Output signal	1000Base-T
Data transmission speed:	10/100/1000 MBit/s
Connector Type:	8P8C (RJ45)
Cable:	Copper twisted pair, e.g. CAT 5.0
Duplex Modes:	Half/Full/Autonegotiaton

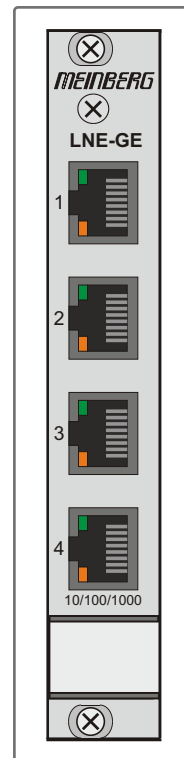

5.2 GPS Receiver

Description

The GPS is using the "Standard Positioning Service" SPS. Navigation messages coming in from the satellites are decoded by the GPS microprocessor in order to track the GPS system time. Compensation of the RF signal's propagation delay is done by automatic determination of the receiver's geographical position. A correction value computed from the satellites' navigation messages drift caused by the board's oven controlled master oscillator (OCXO) and automatically compensates the OCXO's aging. The last state of this value is restored from the battery buffered memory at power-up.

Technical specification

Receiver type:	12 channel GPS C/A-code receiver
Accuracy of pulse outputs:	Depends on oscillator option: < +-100 ns (TCXO, OCXO LQ) < +-50 ns (OCXO-SQ, -MQ, -HQ, -DHQ)
Antenna Cable:	shielded coax
Cable length:	max. 300 m to RG58, max. 700 m to RG213
Antenna Connector:	BNC female
Input GPS:	Antenna circuit 1000 V DC insulated
Mixed frequency	
Reference clock to antenna (GPS-converter):	10 MHz ¹
IF frequency	
Antenna (GPS-converter) to reference clock:	35.4 MHz ¹
	1) these frequencies are transferred via the antenna cable
Power Requirements of the Antenna:	15 V, 100 mA (via antenna cable)

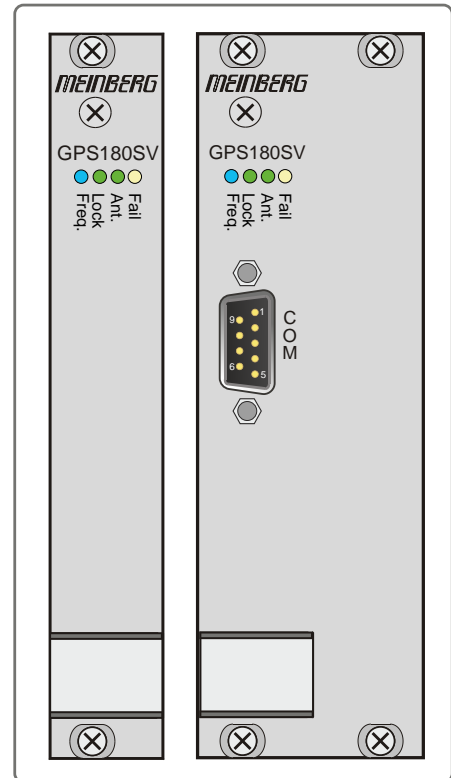

LED Indicators

Freq. LED

blue: Initialisation phase
 green: "warmed up" - oscillator is adjusted

Lock LED

green: positioning complete

Ant. LED

red: no synchronization resp. no antenna connected or short circuit on the antenna line
 green: antenna connected and clock is synchronized

Fail LED

red: no synchronization

Figure right: Status LEDs with COM port option

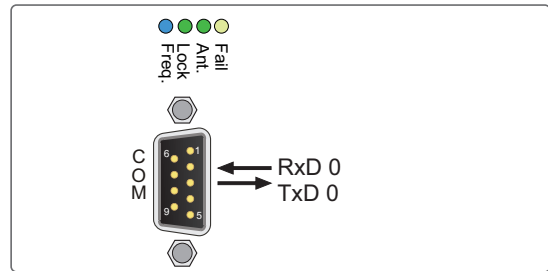

6 LANTIME M900 Rear Connectors

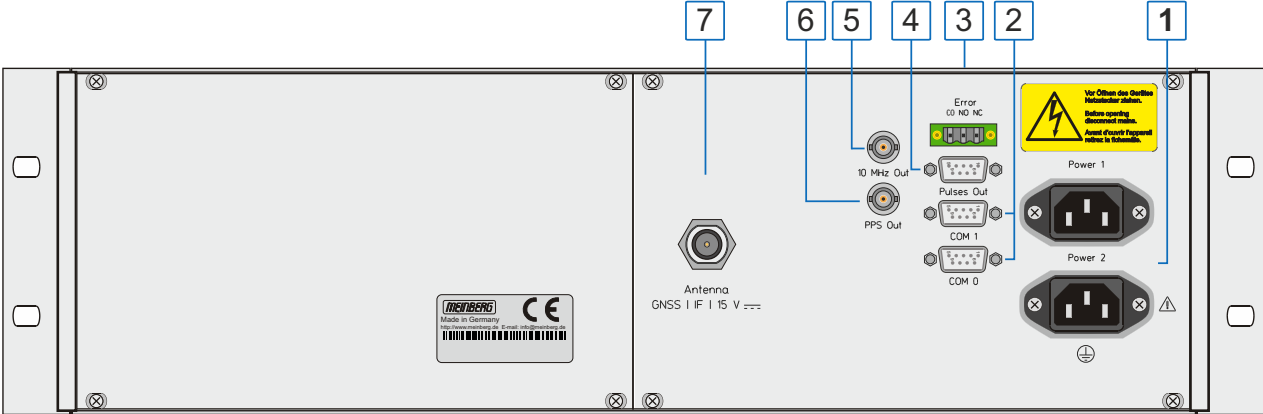

6.1 Power Connector

Connector Type: IEC320 AC inlet

Input Parameter

Nominal Voltage Range: $U_N = 100-240\text{ V}\sim$
 $U_N = 100-200\text{ V}\sim$

Maximum Voltage Range: $U_{max} = 90-265\text{ V}\sim$
 $U_{max} = 90-250\text{ V}\sim$

Nominal Current: $I_N = 0.30\text{ A}$

Nominal Frequency Range: $f_N = 50-60\text{ Hz}$

Maximum Frequency Range: $f_{max} = 47-63\text{ Hz}$

Output Parameter

Maximum Power: $P_{max} = 30\text{ W}$

Max. Heat Emission: $E_{therm} = 108.00\text{ kJ/h (102.37 BTU/h)}$

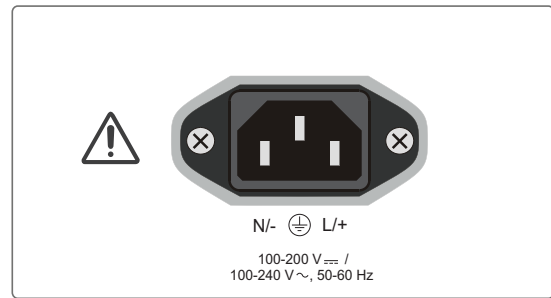

Danger!

This equipment is operated at a hazardous voltage.

Danger of death from electric shock!



- This device must be connected by qualified personnel (electricians) only.
- Never handle exposed terminals or plugs while the power is on.
- All connectors must provide protection against contact with live parts in the form of a suitable plug body!
- Note: Always ensure that wiring is safe!
- Important: The device must be grounded by means of a connection with a correctly installed protective earth conductor (PE).

6.2 RS-232 COMx Timestring

Data transfer	serial
Data transfer	19200 / 8N1 (default)
Time string	Meinberg Standard (default)
Assignment:	
Pin 2:	TxD (transmit)
Pin 3:	RxD (receive)
Pin 5:	GND (ground)
Connection type:	D-Sub female 9pol.
Cable:	data cable (shielded) PC connector 1:1

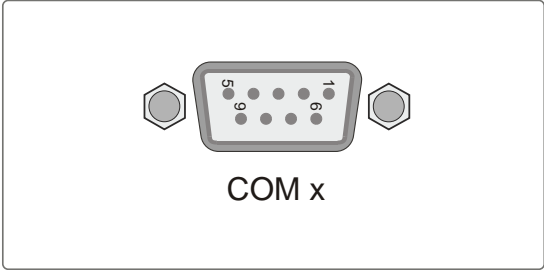

6.3 Error Relay

The device is equipped with a 3-pin relay output labeled with "Error". This 0 V ("dry") relay output is connected to the TTL TIME_SYNC output of the reference clock (GPS, PZF, TCR, etc.) Normally, when the internal reference clock has been synchronized to its source (GPS, DCF77, or IGIG), this relay will switch to "NO" (Normally Open) mode. However, if there is a poor antenna signal or the device has been switched off, the relay will fall back to "NC" (Normally Closed) mode.

This relay can also be switched to a "NO" state using messages, providing a variety of switch states at this output.

Technical Specifications

Max. Switching Voltage:	125 V DC
	140 V AC
Max. Switching Current:	1 A
Max. Switching Load:	DC 30 W
	AC 60 VA
UL/CSA Switching Current:	0.46 A 140 V AC
	0.46 A 65 V DC
	1 A 30 V DC
Response Time:	Approx. 2 ms

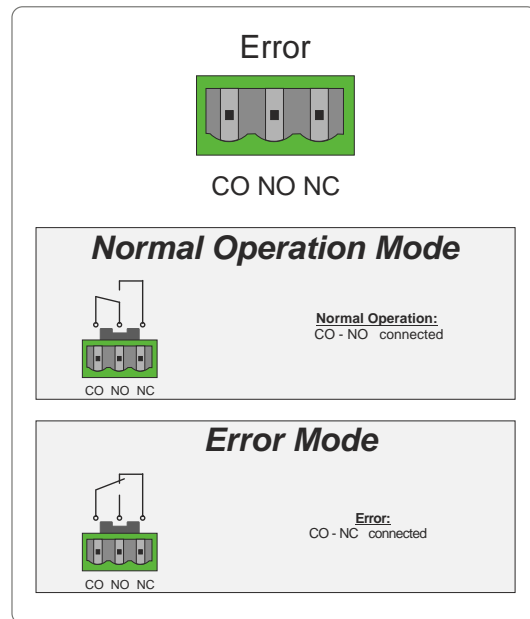

Danger!

This equipment is operated at a hazardous voltage.

Danger of death from electric shock!

- Never work on open terminals and plugs while the power is on!
- When handling the connectors of the error relay cable, always disconnect both ends of the cable from their respective devices!
- Hazardous voltages may be passing through the terminal of the fault signal relay! Never handle the fault signal relay terminal while the signal voltage is present!



6.4 Pulses Outputs

Connector Type:: 9pin D-Sub female

Cable: shielded data line

Pin Layout:

Pin 1: PPS (Pulse Per Second)
 Pin 3: PPM (Pulse Per Minute)
 Pin 5: GND (ground)
 Pin 6: F.Synth
 Pin 7: CAP0
 Pin 8: CAP1
 Pin 9: GND (ground)

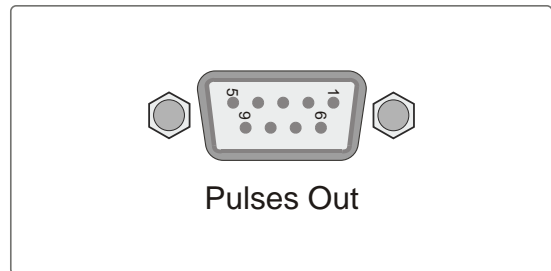

6.5 10 MHz Frequency Output

Output Signal: 10 MHz Frequency

Signal Level: TTL, 2.5 V, 50 Ω Termination

Connection Type: BNC Female

Cable: Coaxial Cable, Shielded

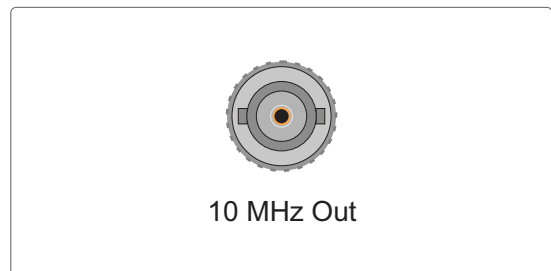

6.6 Pulse per Second Output

Output Signal: PPS (Pulse per Second)

Signal Level: TTL 2.5 V, 50 Ω Termination

Pulse Length: 200 ms

Connector Type: BNC Female

Cable: Coaxial Cable, Shielded

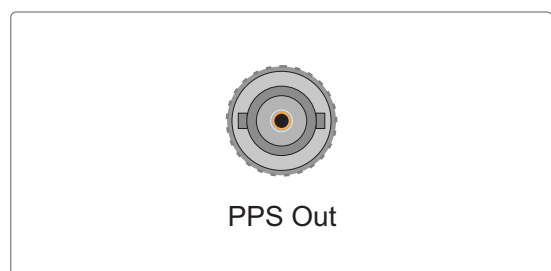

6.7 Antenna Input: GPS Reference Clock

Antenna Input Antenna Circuit, Galvanically Isolated

Dielectric Strength: 1000 V

Receiver Type: 12-Channel GPS Receiver

Signal Support: L1 C/A (1575.42 MHz)

Mixing Frequency

Reference Clock to Antenna
(GPS Converter): 10 MHz ¹

Intermediate Frequency

Antenna (GPS Converter)
to Reference Clock: 35.4 MHz ¹

¹ These frequencies are transferred via the antenna cable

Power Requirements

of the Antenna: 15 V, 100 mA (Via Antenna Cable)

Connection Type: BNC Female/Type-N Female

Cable Type: Coaxial Cable, Shielded

Cable Length: Max. 300 m to RG58,
Max. 700 m to RG213

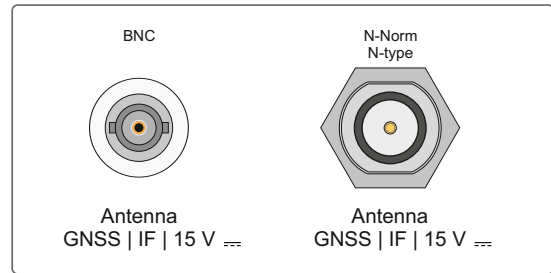

Danger!



Do not work on the antenna system during thunderstorms!

Danger of death from electric shock!

- Do not carry out any work on the antenna system or the antenna cable if there is a risk of lightning strike.
- Do not carry out any work on the antenna system if it is not possible to maintain the prescribed safe distance to exposed lines and electrical substations.

7 Installation of a GPS Antenna



Danger!

Do not mount the antenna without an effective fall arrester!

Danger of death from falling!

- Ensure that you work safely when installing antennas!
- Never work without an effective fall arrester!



Danger!

Do not work on the antenna system during thunderstorms!

Danger of death from electric shock!

- Do not carry out any work on the antenna system or the antenna cable if there is a risk of lightning strike.
- Do not carry out any work on the antenna system if it is not possible to maintain the prescribed safe distance to exposed lines and electrical substations.

Selecting the Antenna Location

To avoid difficulties with synchronization, select a location that allows for an unobstructed view of the sky so as to ensure that enough satellites can be found. The line of sight between the antenna and satellites should not be obstructed in any way. The antenna must also not be installed under power lines or other electrical lighting or power circuits.

Installation Conditions for Optimum Operation:

- clear view of 8° above the horizon or
- clear view towards equator (if clear view of 8° not possible) or
- clear view between 55th north and 55th south parallels (satellite orbits).



Information:

Problems may arise if all of these views are obstructed, as four satellites must be located to calculate a new position.

Important Information Regarding Surge Protection

The following illustration is a visual representation of where there is a risk of hazardous voltage surges in the cable route (from antenna to Meinberg system). The examples below explain how you can protect your Meinberg system from these.

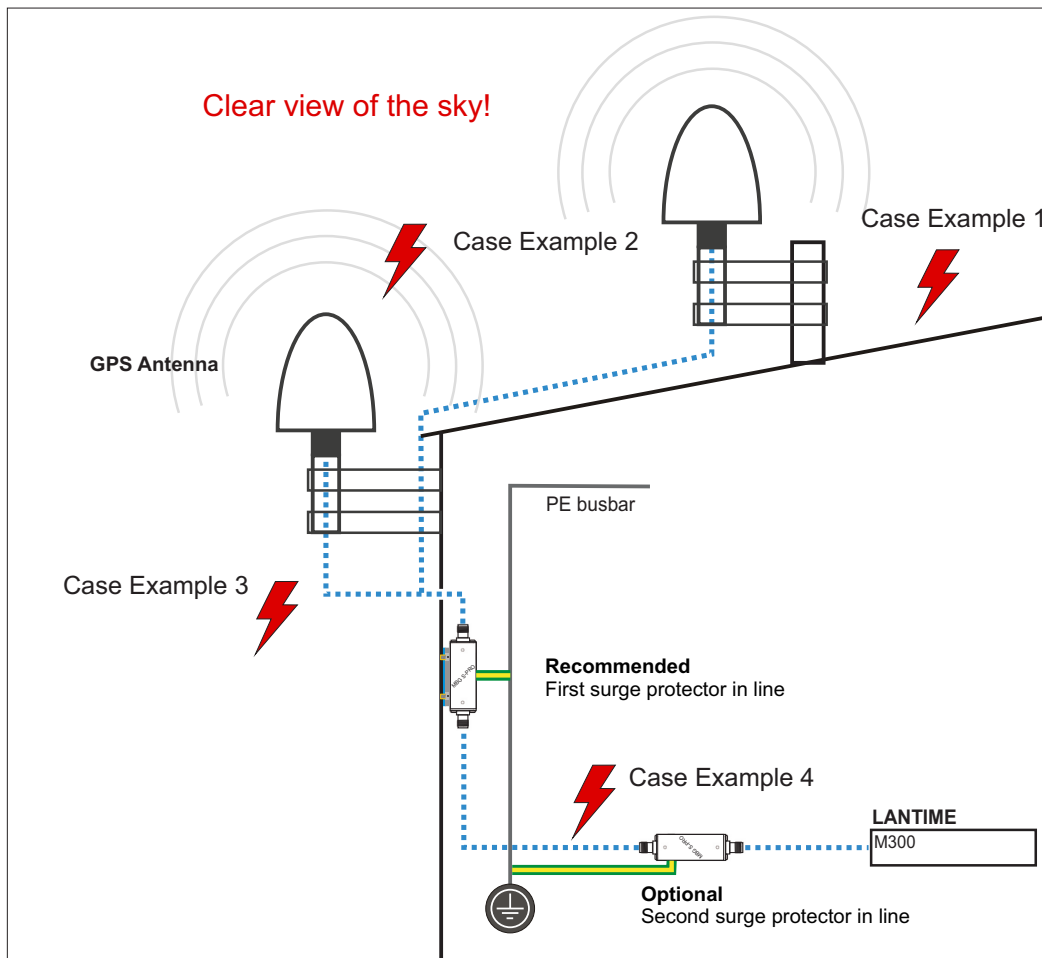

Case Example 1:

An indirect lightning strike near the antenna or coaxial cable may induce transient voltages ("spikes" or "surges"). These spikes can be carried via the coaxial cable to the inside of the building and consequently to the system's receiver. It is therefore strongly recommended to have the surge protector installed at the point directly after the cable enters the building.

Case Example 2:

In the event of a direct lightning strike on the antenna, the resultant transient voltage may be discharged via the PE busbar (GNS L1 antenna only). This prevents the transient voltage from being carried to the coaxial cable and subsequently to the system's receiver.

Case Example 3:

If the length of the coaxial cable between the antenna and point of entry into the building is rather long (e.g., 10 meters), there is a greater risk of transient voltages being introduced into the antenna cable as a result of lightning strike. So the installation of a surge protector immediately after the point of entry into the building is also strongly recommended here.

Case Example 4:

If the cable leading from the point of entry into the building to the Meinberg system is laid together with other cables (for example in a cable duct alongside high-voltage cables), transient voltages may "leak" into the antenna cable, causing damage to your system. To prevent this, a second surge protector can optionally be installed in the line just before the device.

Mounting the Antenna

1.

Use the included mounting kit to mount the antenna at a distance of 50 cm from other antennas, either on a vertical pole of a diameter of no more than 60 mm, or directly onto a wall.

The antenna cable should then be connected to the Type-N connector of the antenna. Feed the other end of the cable into the building through the wall.

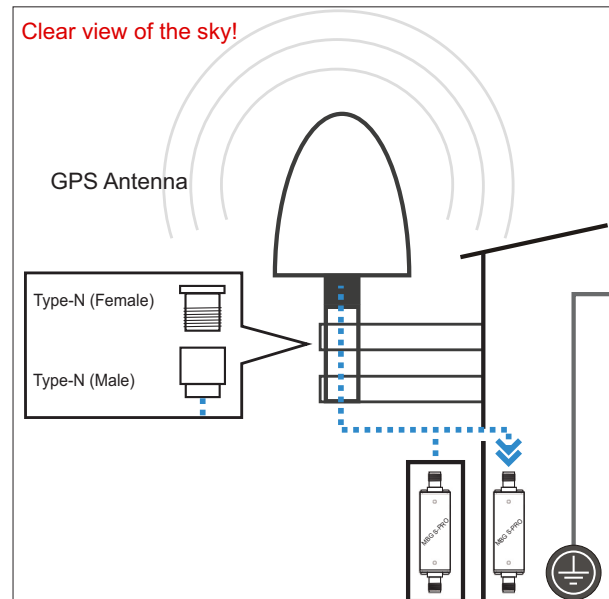

Information:

Make sure that the maximum cable length is not exceeded when installing the antenna cable between the antenna and receiver. The maximum length will depend on the type of cable used (RG213, RG58) and its attenuation factor.

2.

Voltage surges (e.g., caused by lightning strike) may be transmitted along the antenna cable and cause damage to the receiver. Using a MBG S-PRO surge protector can help to protect your receiver against such surges.

If installed in a waterproof housing, the MBG S-PRO can be installed outdoors. However, Meinberg recommends installing the surge protector indoors—as closely to the entrance point of the antenna cable as possible—in order to minimize the risk of surge damage (such as that caused by lightning strike).

Connect the other end of the antenna cable to the female connector of the surge protector.

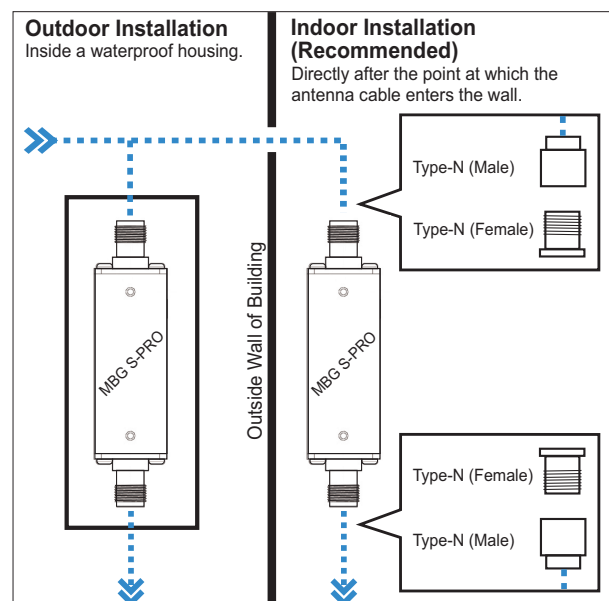

3.

To ground the antenna cable, connect the surge protector to a grounding busbar using a grounding conductor (see illustration).

Once installation is complete, connect the other end of the antenna cable to the surge protector female connector.

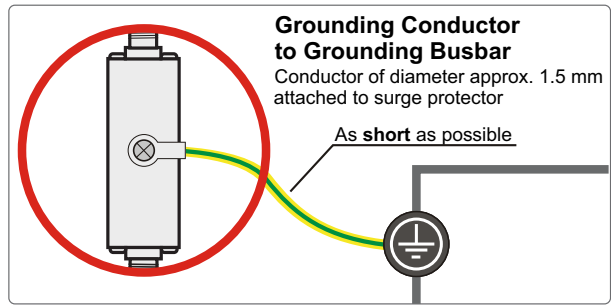

4.

The next step is to connect the supplied coaxial cable from the surge protector to the receiver.

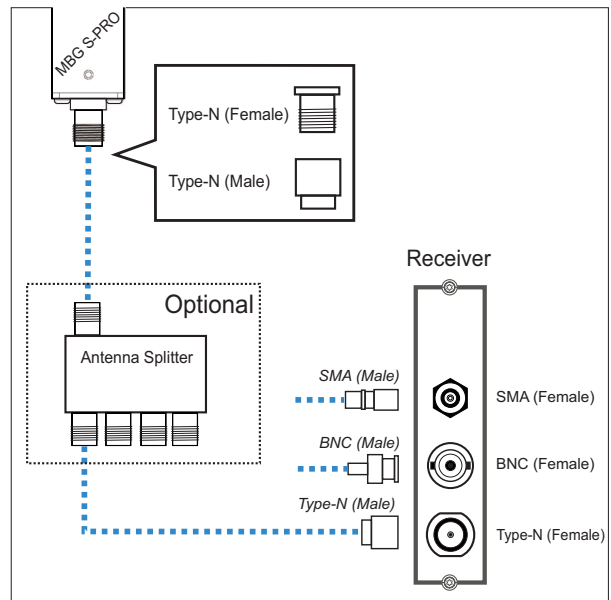

Optional Antenna Splitter

Multiple receivers can be connected to one antenna using the antenna splitter. When doing so, be aware that the total distance, comprising the cable from the antenna to the splitter, and from there to the receiver, must not exceed the maximum cable length. The splitter may be installed at any location between the surge protector and the receivers.



Information:

Please note for installation purposes that GNSS L1 components cannot be directly connected to or used with a Meinberg GPS antenna distributor.

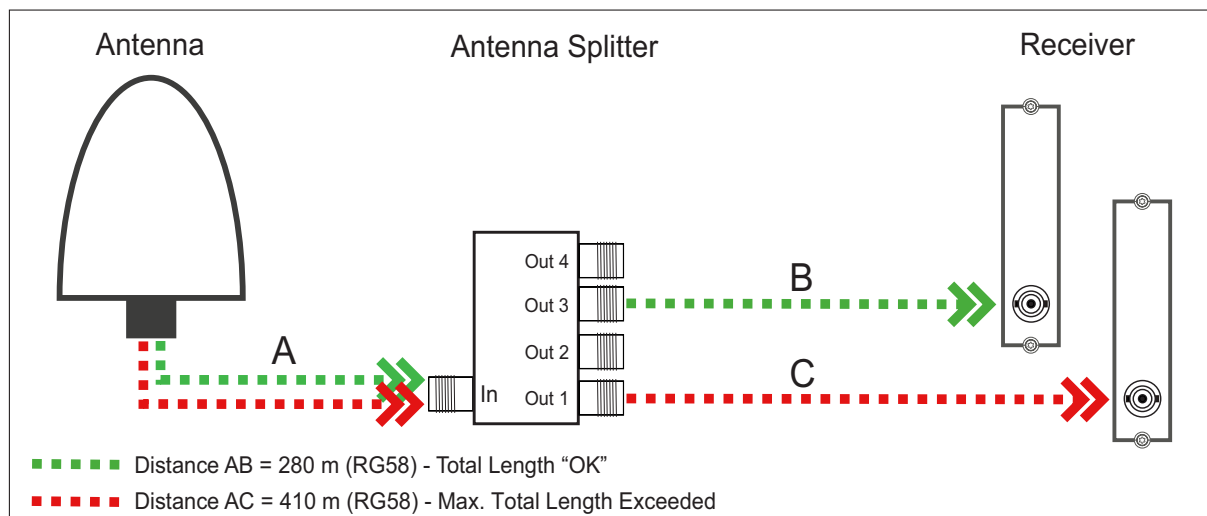

Compensating for Signal Propagation Delay in the Antenna Cable

To enable the connected receiver to compensate for the signal propagation delay inherent in the antenna cable, you will need to enter either the length of your antenna cable in meters or the offset time in nanoseconds into your receiver.

Antenna Cable Length (m):

The satellite signal reception is delayed as a result of coaxial cable used.

Cable	Delay	Usage
RG58U	5 ns/m	For GPS and GNS-UC receivers
H155	4 ns/m	For GNS and GNM receivers

The cable length entered (from antenna to receiver) is used by the system to calculate the delay time and to automatically compensate for propagation delay. A value of 20 m is set by default.

When using a different type of coaxial cable, please use the "By Delay" option. You will need to calculate the delay yourself using the information provided in the product specifications provided by the manufacturer of your coaxial cable.

8 Technical Appendix: GPS Antenna + Accessories

Physical Dimensions:

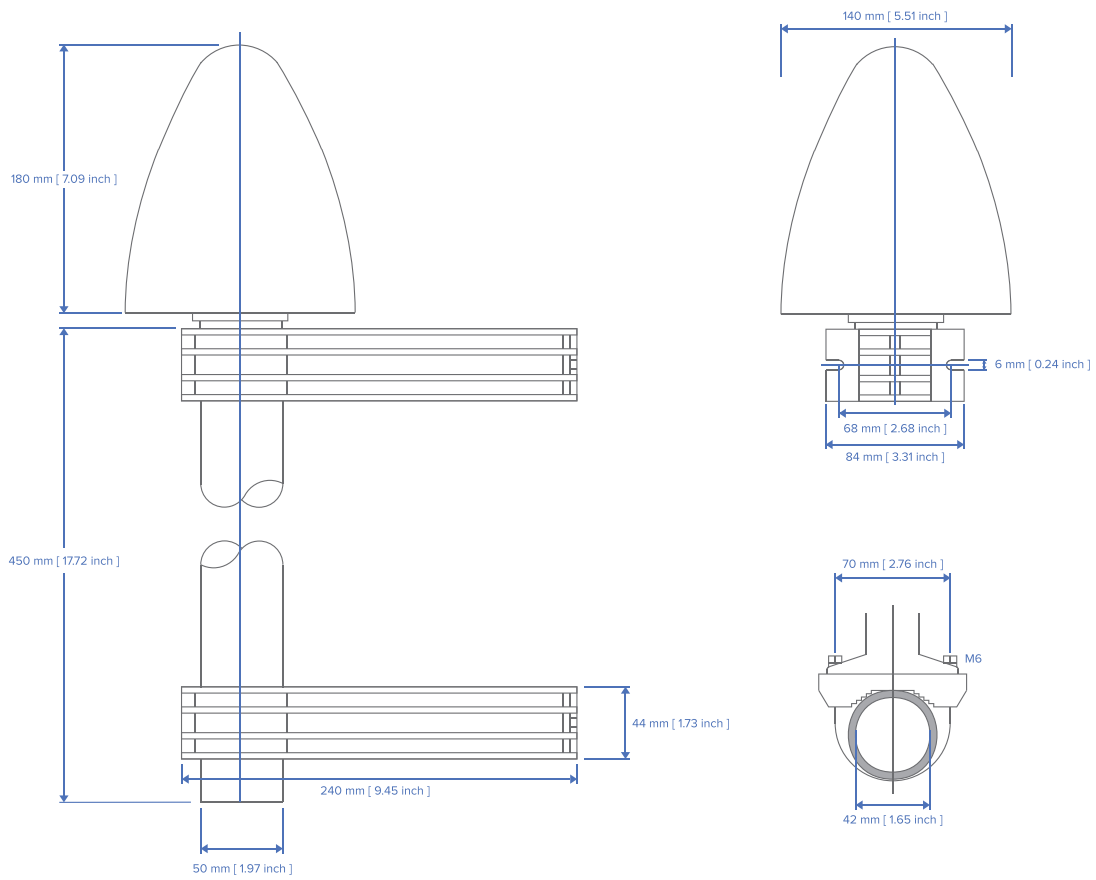

Specifications:

Power Supply:	15 V, 100 mA (provided via antenna cable)	
Reception Frequency:	1575.42 MHz	
Bandwidth:	9 MHz	
Frequencies:	Mixed Frequency	10 MHz
	IF frequency:	35.4 MHz
Connector:	Type-N Female	
Form Factor:	ABS Plastic Case for Outdoor Installation	
IP Rating:	IP66	
Humidity:	95 %	
Temperature Range:	-60 °C to +80 °C (-76 °F to 176 °F)	
Weight:	1.6 kg (3.53 lbs), including mounting kit	

8.1 Technical Specifications: Antenna Cable

The table below shows which coaxial cable types and lengths are supported by Meinberg for each of the receiver types. If you need to purchase a replacement cable at any time, please refer to this table to ensure that you select cable with suitable cutoff frequency and attenuation properties.

Cable Type	Cable Diameter (mm/in)	Attenuation at 100 MHz (db)/100 m/328 ft	Max. Cable Length (m/ft)	Used for Receiver Type
RG58/CU	5/0.2	17	300/984	GPS/GNS-UC/DCF/PZF
RG213	10.3/0.41	7	700/2297	GPS/GNS-UC
H155	5.4/0.21	9.1	70/230	GNM/GNS
H2010 Ultraflex	7.3/0,29	5.8	150/492	GNM/GNS

Please refer to the data sheet of the cable in question for further specifications.

8.2 Antenna Short Circuit



Information:

This information only applies to devices with a front display.

If the antenna line is short-circuited, the following message will be shown on the display:

Antenna Short-Circuit
Disconnect Power!!!

If this message appears, the clock must be switched off and the cause of the problem must be eliminated before the clock can be switched back on. The supply voltage for the antenna/converter unit is around 15 V DC with the antenna connected.

8.3 Technical Specifications: MBG S-PRO Surge Protector

Adapter plug with replaceable gas discharge tube for coaxial signal connections.

Connector Type: Type-N connector female/female. The MBG S-PRO set includes a surge protector (Phoenix CN-UB-280DC-BB), a pre-assembled coaxial cable, and a mounting bracket.

The coaxial cable surge protector must be installed on the antenna line. The shielding is grounded using a conductor that is short as possible. The CN-UB-280DC-BB is equipped with two Type-N female connectors and has no dedicated input/output polarity and no preferred installation orientation.



Phoenix CN-UB-280DC-BB

Features:

- High RF Performance
- Multiple Strike Capability
- 20 kA Surge Protection
- Bidirectional Protection

Installation Method:	Connector Type-Specific Adapter Plug	
Direction of Action:	Line Shield/Earth Ground	
Maximum Continuous Operating Voltage:	UC (Wire-Ground) 195 V AC	280 V DC
Rated Current:	I_N	5 A (25 °C)
Effective Operating Current:	I_C at UC	$\leq 1 \mu\text{A}$
Rated Discharge Current:	I_n (8/20) μs (Core-Earth) I_n (8/20) μs (Core-Shield)	20 kA 20 kA
Total Surge Current:	(8/20) μs (10/350) μs	20 kA 2.5 kA

Max. Discharge Current:	I_{\max} (8/20) μ s Maximum (Core-Shield)	20 kA
Rated Pulse Current:	I_{an} (10/1000) μ s (Core-Shield)	100 A
Impulse Discharge Current:	(10/350) μ s, Peak Value I_{imp}	2.5 kA
Output Voltage Limit:	At 1 kV/ μ s (Core-Earth) spike At 1 kV/ μ s (Core-Earth) spike	\leq 900 V \leq 900 V
Response Time:	tA (Core-Earth) tA (Core-GND)	\leq 100 ns \leq 100 ns
Input Attenuation:	aE, asym.	Typically 0.1 dB (\leq 1.2 GHz) Typically 0.2 dB (\leq 2.2 GHz)
Cut-Off Frequency:	f_g (3 dB), asym. (Shield) in 50 Ω System	$>$ 3 GHz
Standing Wave Ratio:	VSWR in a 50 Ω System	Typically 1.1 (\leq 2 GHz)
Permissible HF Power:	P_{\max} at VSWR = xx (50 Ω System)	700 W (VSWR = 1.1) 200 W (VSWR = ∞)
Capacitance:	(Core-Earth) Asymmetric (Shield)	Typically 1.5 pF Typically 1.5 pF
Surge Current Resistance:	(Core-Earth)	C1 - 1 kV/500 A C2 - 10 kV/5 kA C3 - 100 A D1 - 2.5 kA
Ambient Temperature:	(During Operation)	-40 $^{\circ}$ C ... 80 $^{\circ}$ C
Supported Altitude:		\leq 2000 m (above sea level)
IP Rating:		IP55
Housing Material:		Nickel-Plated Brass Colored Nickel
Dimensions:		Height 25 mm, Width 25 mm, Depth 67 mm
Connection Type:	IN OUT	Type-N Connector 50 Ω Type-N Connector, Female Type-N Connector, Female
Standards/Regulations:		IEC 61643-21 2000 + A1:2008 EN 61643-21 2001 + A1:2009

The original product page of the supplier (see link) of the CN-UB-280DC-BB surge protector is the source of the specifications above. Please refer to the manufacturer's product page at the following link for detailed specifications as well as a variety of product-specific documents:

<https://www.phoenixcontact.com/online/portal/gb/?uri=pxc-oc-itemdetail:pid=2818850>

8.3.1 MBG S-PRO: Physical Dimensions

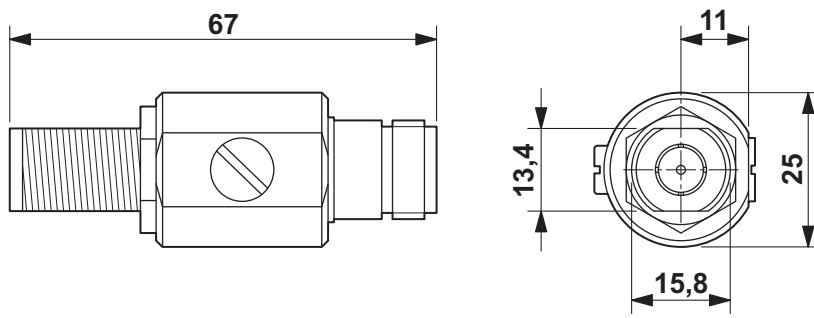

8.3.2 Installation and Grounding

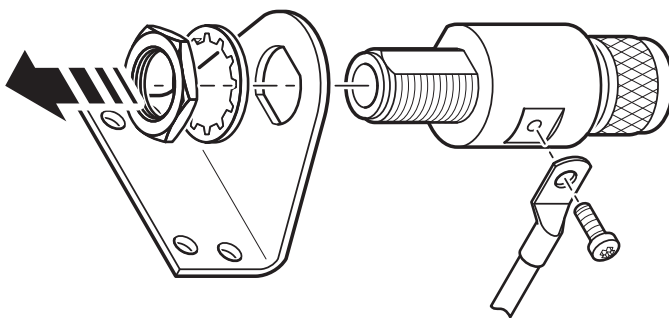

9 RoHS and WEEE

Compliance with EU Directive 2011/65/EU (RoHS)

We hereby declare that this product is compliant with the European Union Directive 2011/65/EU and its delegated directive 2015/863/EU "Restrictions of Hazardous Substances in Electrical and Electronic Equipment". We ensure that electrical and electronic products sold in the EU do not contain lead, cadmium, mercury, hexavalent chromium, polybrominated biphenyls (PBBs), polybrominated diphenyl ethers (PBDEs), bis(2-ethylhexyl)phthalat (DEHP), benzyl butyl phthalate (BBP), dibutyl phthalate (DBP), or diisobutyl phthalate (DIBP) above the legal limits.



WEEE status of the product

This product is handled as a B2B (Business to Business) category product. To ensure that the product is disposed of in a WEEE-compliant fashion, it can be returned to the manufacturer. Any transportation expenses for returning this product (at end-of-life) must be covered by the end user, while Meinberg will bear the costs for the waste disposal itself.



