



The Synchronization Experts.



MANUAL

LANTIME Firmware 7.06

Configuration and Management Manual

August 17, 2022

Meinberg Funkuhren GmbH & Co. KG

Table of Contents

| | | |
|----------|--|-----------|
| 1 | Imprint | 1 |
| 2 | Important Safety Information | 2 |
| 2.1 | Important Safety Information and Safety Precautions | 2 |
| 2.2 | Used Symbols | 3 |
| 2.3 | Product Documentation | 4 |
| 2.4 | Safety during Installation | 5 |
| 2.5 | Connection of Protective Earth Conductor/Grounding | 8 |
| 2.6 | Safety During Operation | 9 |
| 2.7 | Safety during Maintenance | 10 |
| 2.8 | Handling of Batteries | 11 |
| 2.9 | Cleaning and Care | 12 |
| 2.10 | Prevention of ESD Damage | 12 |
| 2.11 | Return of Electrical and Electronic Equipment | 13 |
| 3 | Before you start | 14 |
| 3.1 | Text and Syntax Conventions | 14 |
| 3.2 | Required Tools | 15 |
| 3.3 | Abbreviation List | 16 |
| 4 | Introduction | 18 |
| 4.1 | Network Configuration Concept | 19 |
| 4.2 | Additional Features | 19 |
| 4.3 | User Interface | 19 |
| 4.4 | Input and Output Options | 20 |
| 4.5 | The Network Time Protocol (NTP) | 21 |
| 4.5.1 | Computer Platforms Supported by NTP | 21 |
| 4.6 | Option: Precision Time Protocol (PTP) / IEEE 1588 | 22 |
| 4.6.1 | General Information | 23 |
| 4.6.2 | Functionality in Master Systems | 24 |
| 4.6.3 | Functionality in Slave Systems | 25 |
| 4.6.4 | PTPv2 IEEE 1588-2008 Configuration Guide | 26 |
| 5 | Unboxing | 32 |
| 6 | LANTIME Installation | 34 |
| 7 | Security User Guide / Security Advisories | 37 |
| 7.1 | General Informations | 38 |
| 7.2 | Optimizing Management Access Security | 40 |
| 7.3 | User Management/Administration | 44 |
| 7.3.1 | LANTIME User Management | 44 |
| 7.3.2 | External User Authentication: LDAP(S), Radius and TACACS+ | 46 |
| 7.4 | Securing the NTP Time Service | 49 |
| 7.4.1 | Configuring Symmetric Key Authentication | 49 |
| 7.4.2 | Configuring Network Time Security for External NTP Servers | 52 |
| 7.5 | Event Log Delivery | 53 |
| 7.6 | Update and Backup LANTIME Firmware | 54 |
| 8 | Antenna and Receiver Information | 57 |
| 8.1 | Reference Time Sources | 57 |
| 8.1.1 | Meinberg GPS Receiver | 57 |
| 8.1.2 | Meinberg GNSS Receiver (GPS, GLONASS, Galileo, BeiDou) | 58 |
| 8.1.3 | PZF - DCF77 Long Wave Receiver | 59 |

| | | |
|-----------|---|------------|
| 8.1.4 | MSF Receiver | 60 |
| 8.1.5 | WWVB Receiver | 62 |
| 8.1.6 | TCR Receiver | 63 |
| 8.2 | GNSS Signal Reception | 64 |
| 8.2.1 | Meinberg GPS Antenna/Converter | 65 |
| 8.2.2 | General GNSS Antennae | 68 |
| 8.2.3 | Powering up a GNSS Receiver | 71 |
| 8.3 | Long Wave Signal Reception | 72 |
| 8.3.1 | Introduction | 72 |
| 8.3.2 | Mounting and Installation of a Longwave Antenna | 73 |
| 8.3.3 | DCF77 / PZF Receiver | 75 |
| 8.4 | Cable Types | 75 |
| 9 | LTOS7 Management and Monitoring | 76 |
| 9.1 | Via Web GUI | 76 |
| 9.1.1 | Main Menu | 76 |
| 9.1.2 | Network | 82 |
| 9.1.3 | Notification | 92 |
| 9.1.4 | Security | 107 |
| 9.1.5 | NTP | 119 |
| 9.1.6 | PTP | 137 |
| 9.1.7 | FDM - Frequency Deviation Monitoring | 160 |
| 9.1.8 | System | 175 |
| 9.1.9 | Statistics | 199 |
| 9.1.10 | Clock | 206 |
| 9.1.11 | I/O Configuration | 228 |
| 9.1.12 | Sync Monitoring | 250 |
| 9.1.13 | Documentation and Support | 299 |
| 9.2 | Via Front Panel Display | 301 |
| 9.2.1 | LANTIME Display Types | 301 |
| 9.2.2 | Front Display - Root Menu | 306 |
| 9.2.3 | Menu: Reference Time | 308 |
| 9.2.4 | Menu: Time Service | 325 |
| 9.2.5 | Menu: Network | 346 |
| 9.2.6 | Menu: System | 351 |
| 9.2.7 | USB Stick Menu | 358 |
| 9.3 | Via Serial Connection | 361 |
| 9.4 | Via SNMP | 362 |
| 9.4.1 | The Simple Network Management Protocol | 362 |
| 9.4.2 | MIB Objects of a LANTIME | 363 |
| 9.4.3 | SNMP Traps | 368 |
| 10 | Troubleshooting and Alarming | 377 |
| 10.1 | NTP Messages | 377 |
| 10.2 | Ref. Clock Messages | 378 |
| 10.3 | Network Messages | 383 |
| 10.4 | Miscellaneous Messages | 384 |
| 11 | Support Information | 386 |
| 11.1 | Basic Customer Support | 387 |
| 11.2 | Support Ticket System | 387 |
| 11.3 | How to download a Diagnostic File | 388 |
| 11.3.1 | Download via Web GUI | 388 |
| 11.3.2 | Download via USB Stick | 388 |
| 11.4 | Self-Help Online Tools | 389 |
| 11.5 | NTP and IEEE 1588-PTP online tutorials | 389 |
| 11.6 | The Meinberg Academy introduction and offerings | 390 |
| 11.7 | Meinberg Newsletter | 390 |

| | |
|---|------------|
| 12 Appendix | 391 |
| 12.1 LANTIME CPU - Central Processing Unit | 391 |
| 12.1.1 Technical Specifications LAN CPU | 392 |
| 12.1.2 Technical Specifications - IMS CPU-C15G2 | 393 |
| 12.2 Description of Time String Formats | 395 |
| 12.2.1 Format of the Meinberg Standard Time String | 395 |
| 12.2.2 Format of the Meinberg GPS Time String | 395 |
| 12.2.3 Format of the Meinberg Capture String | 397 |
| 12.2.4 Format of the SAT Time String | 398 |
| 12.2.5 Format of the Uni Erlangen String (NTP) | 399 |
| 12.2.6 Format of the NMEA 0183 String (RMC) | 401 |
| 12.2.7 Format of the NMEA 0183 String (GGA) | 402 |
| 12.2.8 Format of the NMEA 0183 String (ZDA) | 403 |
| 12.2.9 Format of the ABB SPA Time String | 404 |
| 12.2.10 Format of the Computime Time String | 405 |
| 12.2.11 Format of the RACAL Standard Time String | 406 |
| 12.2.12 Format of the SYSPLEX-1 Time String | 407 |
| 12.2.13 Format of the ION Time String | 408 |
| 12.2.14 Format of the ION Blanked Time String | 409 |
| 12.2.15 Format of the IRIG-J Timecode | 410 |
| 12.3 Description of Time Code Formats | 411 |
| 12.4 Description of Programmable Pulse Signal Types | 413 |
| 12.5 SyncMon Formats | 415 |
| 12.6 Third party software | 416 |
| 12.6.1 Operating System GNU/Linux | 416 |
| 12.6.2 Samba | 416 |
| 12.6.3 Network Time Protocol Version 4 (NTP) | 417 |
| 12.6.4 lighttpd | 418 |
| 12.6.5 GNU General Public License (GPL) | 419 |
| 12.7 List of Literature | 423 |

1 Imprint

Meinberg Funkuhren GmbH & Co. KG
Lange Wand 9, 31812 Bad Pyrmont, Germany

Phone: + 49 (0) 52 81 / 93 09 - 0
Fax: + 49 (0) 52 81 / 93 09 - 230

Website: <https://www.meinbergglobal.com>
Email: info@meinberg.de

Date: August 17, 2022

Manual
Version: 1.03

2 Important Safety Information

2.1 Important Safety Information and Safety Precautions

The following safety information must be observed whenever the device is being installed or operated. Failure to observe this safety information and other special warnings or operating instructions in the product manuals constitutes improper usage and may violate safety standards and the manufacturer's requirements.



Depending on the configuration of your device or installed options, some information may not specifically apply to your device.



The device satisfies the requirements of the following EU regulations: EMC Directive, Low Voltage Directive, RoHS Directive and—where applicable—the Radio Equipment Directive.

If a procedure is marked with the following signal words, you may only proceed with it if you have understood and fulfilled all requirements. Hazard notices and other relevant information are classified and indicated as such in this manual according to the following system:



DANGER!

This signal word indicates a hazard with a high risk level . Such a notice refers to a procedure or other action that will very likely result in serious injury or even death if not observed or if improperly performed.



WARNING!

This signal indicates a hazard with a medium risk level . Such a notice refers to a procedure or other action that may result in serious injury or even death if not observed or if improperly performed.



CAUTION!

This signal word indicates a hazard with a low risk level . Such a notice refers to a procedure or other action that may result in minor injury if not observed or if improperly performed.















ATTENTION!

This signal word refers to a procedure or other action that may result in product damage or the loss of important data if not observed or if improperly performed.

2.2 Used Symbols

The following symbols and pictograms are used in this manual. Pictograms are used in particular to indicate potential hazards in all hazard categories.

| Symbol | Beschreibung / Description |
|---|---|
|  | IEC 60417-5031 Gleichstrom / <i>Direct current</i> |
|  | IEC 60417-5032 Wechselstrom / <i>Alternating current</i> |
|  | IEC 60417-5017 Erdungsanschluss / <i>Earth (ground) terminal</i> |
|  | IEC 60417-5019 Schutzleiteranschluss / <i>Protective earth (ground) terminal</i> |
|  | ISO 7000-0434A Vorsicht / <i>Caution</i> |
|  | IEC 60417-6042 Vorsicht, Risiko eines elektrischen Schlages / <i>Caution, risk of electric shock</i> |
|  | IEC 60417-5041 Vorsicht, heiße Oberfläche / <i>Caution, hot surface</i> |
|  | IEC 60417-6056 Vorsicht, Gefährlich sich bewegende Teile / <i>Caution, moving parts</i> |
|  | IEC 60417-6172 Trennen Sie alle Netzstecker / <i>Disconnect all power connectors</i> |
|  | IEC 60417-5134 Elektrostatisch gefährdete Bauteile / <i>Electrostatic Discharge Sensitive Devices</i> |
|  | IEC 60417-6222 Information generell / <i>General information</i> |
|  | 2012/19/EU Dieses Produkt fällt unter die B2B Kategorie. Zur Entsorgung muss es an den Hersteller übergeben werden. <i>This product is handled as a B2B-category product. To ensure that the product is disposed of in a WEEE-compliant fashion, it must be returned to the manufacturer.</i> |

2.3 Product Documentation

Detailed product documentation is provided on a USB flash drive delivered with the Meinberg system. The manuals can also be downloaded from the Meinberg website at <https://www.meinbergglobal.com>, where you can enter your system name into the search box at the top of the page to find the relevant manual. Alternatively, contact Meinberg Support for further assistance.

The "Docs & Support" menu on the Web Interface also provides user manuals for time server administrators.



This manual contains important safety instructions for the installation and operation of the device. Please read this manual thoroughly before using the device.

This device may only be used for the purpose described in this manual. In particular, the specified operating limits of the device must be heeded. The person setting up the device is responsible for safety matters in relation to any larger system in which the device is installed!

Failure to observe these instructions may have an adverse impact on device safety!

Please keep this manual in a safe place.

Target Readership

This manual is only intended to be used by qualified electricians, or by persons who have been appropriately instructed by a qualified electrician and who are familiar with applicable national standards and with safety rules & regulations. This device may only be installed, set up, and operated by qualified personnel.

2.4 Safety during Installation



WARNING!

Pre-Operation Procedures and Preparation for Use

This mountable device has been designed and examined in accordance with the requirements of the standard IEC 62368-1 "Audio/Video, Information and Communication Technology Equipment - Part 1: Safety Requirements".

When the mountable device is to be used as part of a larger unit (e.g., electrical enclosure), there will be additional requirements in the IEC 62368-1 standard that must be observed and complied with. General requirements regarding the safety of electrical equipment (such as IEC, VDE, DIN, ANSI) and applicable national standards must be observed in particular.

The device has been developed for use in the industrial sector or in home environments and may only be used in such environments. In environments at risk of high environmental conductivity ("high pollution degree" according to IEC 60664-1), additional measures such as installation of the device in an air-conditioned electrical cabinet may be necessary.

Transport, Unpacking, Installation

If the unit has been brought into the usage area from a cold environment, condensation may develop; in this case, wait until the unit has adjusted to the temperature and is completely dry before setting it up.

When unpacking & setting up, and before operating the equipment, be sure to read the information on installing the hardware and the specifications of the device. These include, for example, dimensions, electrical characteristics, or necessary environmental conditions.

Fire safety standards must be upheld with the device in its installed state.

The device must not be damaged in any way when mounting it. In particular, holes must not be drilled into the housing.

For safety reasons, the device with the highest mass should be installed at the lowest position in the rack. Further devices should be installed from the bottom, working your way up.

The device must be protected against mechanical & physical stresses such as vibration or shock.



Connecting Data Cables

Do not connect or disconnect data cables during a thunderstorm, as doing so presents a risk in the event of a lightning strike.

The device cables must be connected or disconnected in the order specified in the user documentation for the device. Cables should always be held by the connector body when connecting or disconnecting them. Never pull a connector out by pulling on the cable. Doing so may cause the plug to be detached from the cable or cause damage to the plug itself.

Cables must be installed so that they do not represent a health & safety hazard (e.g., tripping) and are not at risk of damage (e.g., kinks).

Connecting the Power Supply

This equipment is operated at a hazardous voltage. Failure to observe the safety instructions in this manual may result in serious injury, death or property damage.

Before the device is connected to the power supply, a grounding conductor must be connected to the earth terminal of the device.

The power supply should be connected with a short, low-inductance cable.

Before operation, check that all cables and lines work properly and are undamaged. Ensure in particular that the cables do not have kinks, that they are not wound too tightly around corners, and that no objects are placed on the cables.

Ensure that all connections are secure—make sure that the lock screws of the power supply plug are tightened when using a 3-pin MSTB or 5-pin MSTB connector (see diagram, LANTIME M300 power supply).

5-Pin MSTB Connector

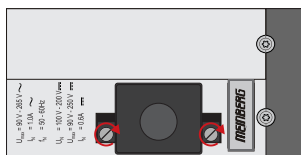

3-Pin MSTB Connector

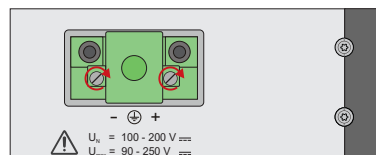

Faulty shielding or cabling and improperly connected plugs are a health & safety risk (risk of injury or death due to electrical shock) and may damage or even destroy your Meinberg device or other equipment.

Ensure that all necessary safety precautions have been taken. Connect all cables to the device only while the device is de-energized before turning on the power. Observe the safety instructions on the device itself (see safety symbols).

The metal chassis of the device is grounded. When installing the device in an electrical enclosure, it must be ensured that adequate clearance is provided, creepage distances to adjacent conductors are maintained, and that there is no risk of short circuits.

In the event of a malfunction or if servicing is required (e.g., damage to the chassis or power cable, ingress of fluids or foreign objects), the power supply may be cut off.

Please address any questions regarding your building's electrical, cable or antenna installations to the person or department responsible for that installation within your building.

| AC Power Supply | DC Power Supply |
|---|---|
| <ul style="list-style-type: none"> • The device is a Protection Class 1 device and may only be connected to a grounded outlet (TN system). • For safe operation, the installation must be protected by a fuse of a rating not exceeding 16 A and equipped with a residual-current circuit breaker in accordance with applicable national standards. • The disconnection of the appliance from the mains power supply must always be performed from the mains socket and not from the appliance itself. • Mains-powered appliances are equipped with a safety-tested mains cable designed for use in the country of operation and may only be connected to a grounded shockproof socket, otherwise electric shock may occur. • Make sure that the mains socket on the appliance or the mains socket of the house installation is readily accessible for the user so that the mains cable can be pulled out of the socket in an emergency. | <ul style="list-style-type: none"> • In accordance with IEC 62368-1, it must be possible to disconnect the appliance from the supply voltage from a point other than the appliance itself (e.g., from the primary circuit breaker). • The power supply plug may only be fitted or dismantled while the appliance is isolated from the power supply (e.g., disconnected at the primary circuit breaker). • Supply cables must be adequately secured and have an adequate wire gauge size. <p style="text-align: center;"><i>Connection Cable Wire Gauge:</i> $1\text{ mm}^2 - 2.5\text{ mm}^2$ 17 AWG – 13 AWG</p> <ul style="list-style-type: none"> • The power supply of the device must have a suitable disconnection mechanism such as a switch. This disconnection mechanism must be readily accessible in the vicinity of the appliance and marked accordingly as a cut-off mechanism for the appliance. |

2.5 Connection of Protective Earth Conductor/Grounding



ATTENTION!



In order to ensure that the device can be operated safely and to meet the requirements of IEC 62368-1, the device must be correctly connected to the protective earth conductor via the protective earth connection terminal.



If an external ground connection is provided on the housing, it must be connected to the grounding busbar (earthing busbar) for safety reasons before connecting the power supply. Like this, any possible leakage current on the housing is safely discharged to earth.

The screw, washer and toothed lock washer necessary for mounting the grounding cable are located at the grounding point of the housing. A grounding cable is not included in the contents of delivery.

Note:

Please use a grounding cable with cross-section $\geq 1.5 \text{ mm}^2$, as well as a suitable grounding clamp/lug. Always ensure that the connection is properly crimped!

2.6 Safety During Operation



WARNING!

Avoiding Short-Circuits

Protect the device against all ingress of solid objects or liquids. Ingress presents a risk of electric shock or short-circuiting!

Ventilation Slots

Ensure that the ventilation slots are clean and uncovered at all times. Blocked ventilation slots may cause heat to be trapped in the system, resulting in overheating. This may cause your device to malfunction or fail.

Appropriate Usage

The device is only deemed to be appropriately used and EMC limits (electromagnetic compatibility) are only deemed to be observed if the chassis cover is properly fitted (thus ensuring that the device is properly cooled, fire-safe, and shielded against electrical, magnetic and electromagnetic fields).



Switching the Device Off in the Event of a Malfunction or when Repairs are Required

It is not sufficient to simply switch off the device itself in order to disconnect the power supply. If the device is malfunctioning, or if repairs become necessary, the device must be isolated from all power supplies immediately.

To do so, follow the procedure below:

- Switch off the device from the unit itself.
- Pull out all power supply plugs.
- Inform the person or department responsible for your electrical installation.
- If your device is connected to an Uninterruptible Power Supply (UPS), it will remain operational even after pulling the UPS power cable from the mains socket. In this case, you will need to shut down your UPS in accordance with the user documentation of your UPS system.

2.7 Safety during Maintenance



WARNING!

The device must never be opened. Repairs to the device may only be performed by the manufacturer or by authorized personnel. Improper repairs may expose the user to considerable safety risks (electric shock, fire hazard).

Opening the device or individual device components in an unauthorized fashion may also expose the user to considerable risks and invalidate your warranty. Meinberg Funkuhren accepts no liability for consequences arising from such unauthorized actions.



Danger from moving parts—do not touch moving parts.



Parts of the device may become very hot during operation. Do not touch these surfaces! If necessary, switch off the device before installing or removing any equipment, and allow it to cool down.

2.8 Handling of Batteries



WARNING!

The lithium battery on the receiver modules has a life of at least ten years. Should it be necessary to replace it, please note the following:

Improper handling of the battery can lead to an explosion or to a leakage of flammable liquids or gases.

- Never short-circuit the battery.
- Never attempt to recharge the battery.
- Never throw the battery into a fire.
- The battery must only be exposed to the barometric pressure range specified by the battery manufacturer.
- The battery must only ever be replaced with one of the same type or a comparable type recommended by the manufacturer. The battery must only be replaced by the manufacturer or an authorized technician.
- Never dispose of the battery in a mechanical crusher or shredder, or in an open fire or furnace.

Please consult your local waste disposal regulations for information on how to dispose of hazardous waste.



IMPORTANT!

The battery is used to power components such as the RAM and the reserve real-time backup clock for the reference clock.

If the battery voltage drops below 3 V DC, Meinberg recommends having the battery replaced. If the battery voltage drops below the specified minimum, the following behavior may be observed in the reference clock:

- The reference clock may have the wrong date or wrong date upon power-up
- The reference clock repeatedly starts in Cold Boot mode
- Some of the configurations saved for the reference clock may be lost

2.9 Cleaning and Care



ATTENTION!

Never clean the device using liquids! Water ingress is a significant safety risk for the user (e.g., electric shock).

Liquids can cause irreparable damage to the electronics of the device! The ingress of liquids into the device chassis may cause short circuits in the electronic circuitry.

Only clean with a soft, dry cloth. Never use solvents or cleaners.

2.10 Prevention of ESD Damage



ATTENTION!

An ESDS device (electrostatic discharge-sensitive device) is any device at risk of damage or malfunction due to electrostatic discharges (ESD) and thus requires special measures to prevent such damage or malfunction. Systems and modules with ESDS devices usually bear the following symbol:



Symbol Indicating Devices with ESDS Components

The following measures will help to protect ESDS components from damage and malfunction.

When preparing to dismantle or install devices:

Ground your body (for example, by touching a grounded object) before touching sensitive devices.

Ensure that you wear a grounding strap on your wrist when handling such devices. These straps must in turn be attached to an uncoated, non-conductive metal part of the system.

Use only tools and devices that are free of static electricity.

When transporting devices:

Devices must only be touched or held by the edges. Never touch any pins or conductors on the device.

When dismantling or installing devices:

Avoid coming into contact with persons who are not grounded. Such contact may compromise your connection with the earth conductor and thus also compromise the device's protection from any static charges you may be carrying.

When storing devices:

Always store devices in ESD-proof ("antistatic") bags. These bags must not be damaged in any way. ESD-proof bags that are crumpled or have holes cannot provide effective protection against electrostatic discharges.

ESD-proof bags must have a sufficient electrical resistance and must not be made of conductive metals if the device has a lithium battery fitted on it.

2.11 Return of Electrical and Electronic Equipment



ATTENTION!

WEEE Directive on Waste Electrical and Electronic Equipment 2012/19/EU
(WEEE Waste Electrical and Electronic Equipment)

Waste Separation

Product Category: According to the device types listed in Annex I of the WEEE Directive, this product is classified as "IT and Telecommunications Equipment".



This product satisfies the labeling requirements of the WEEE Directive. The product symbol on the left indicates that this electronic product must not be disposed of in domestic waste.

Return and Collection Systems

When disposing of your old equipment, please use the national return or collection systems available to you. Alternatively, you may contact Meinberg, who will provide further assistance.

The return of electronic waste may not be accepted if the device is soiled or contaminated in such a way that it potentially presents a risk to human health or safety.

Return of Used Batteries

The EU Battery Directive prohibits the disposal of batteries marked with the WEEE trashcan symbol above in household waste.

3 Before you start

3.1 Text and Syntax Conventions

This chapter briefly describes the text and syntax conventions used in this manual.

Web Interface: example "Menu Network"

Submenu "Network → Network Interfaces"

Items in Submenu "Network → Network Interfaces → IPv4"

The menu navigation is logically separated by an right arrow (→).

Directory names / Paths Example: Lantime configuration file

The directory names and paths are displayed in italics.

Code and CLI Commands

```
- cmd/www-upload.htm
```

```
#Program code and CLI commands are displayed in a grey box with monospace font.
```

User passwords:

The following characters are currently allowed for user passwords and shared secret:

Allowed character set for both:

```
validchars[] = abcdefghijklmnopqrstuvwxyz  
ABCDEFGHIJKLMNPNPQRSTUVWXYZ  
0123456789  
=-_:#*?@/+![]
```

3.2 Required Tools

| LANTIME IMS SERIES | | | | | | | |
|-----------------------|---------------|----------------|----------------|---------------|----------------|-------------------------------|-------------------|
| | LANTIME M1000 | LANTIME M1000S | LANTIME M2000S | LANTIME M3000 | LANTIME M3000S | LANTIME M4000 | LANTIME M500 |
| Mounting Rackears | TORX T20 | TORX T20 | TORX T20 | TORX T20 | TORX T20 | TORX T20 | X |
| Mounting DIN rail | X | X | X | X | X | X | Phillips PH1 x 80 |
| Replacing IMS modules | TORX T8 | TORX T8 | TORX T8 | TORX T8 | TORX T8 | TORX T8 | TORX T8 |
| FAN Installation | TORX T8 | TORX T8 | TORX T8 | TORX T8 | X | TORX T8 Flat head Screwdriver | X |

| LANTIME SERIES | | | | | | | |
|-------------------|-------------------|--------------|--------------|-------------------|--------------|--------------|----------|
| | LANTIME M100 | LANTIME M200 | LANTIME M300 | LANTIME M400 | LANTIME M600 | LANTIME M900 | SyncFire |
| Mounting Rackears | X | TORX T20 | TORX T20 | X | TORX T20 | TORX T20 | X |
| Mounting DIN rail | Phillips PH1 x 80 | X | X | Phillips PH1 x 80 | X | X | X |
| Replacing Modules | X | X | X | X | X | TORX T8 | TORX T10 |



Figure: Required tools from left to right - INBUS 2,5mm, Phillips PH1 x 80, Flat head Screwdriver, TORX T20, TORX T8

3.3 Abbreviation List

| | | | |
|-----------|---|-----------|--|
| AFNOR | Association Francaise de Normalisation time codes | IP | range (PTP) Internet Protocol |
| AC | Alternating Current | IP 20 | Protection Class 20 |
| ASCII | American Standard Code for Information Interchange | IRIG | Inter-range instrumentation group time codes |
| BMC | Best Master Clock | LCD | Liquid Crystal Display |
| BNC | Bayonet Neil Councilman connector | LDAP(S) | Lightweight Directory Access Protocol |
| Bps | Bytes per second | LED | Light-Emitting Diode |
| bps | Bits per second | LINUX | Unix-like multi-user computer operating system |
| CAT5 | Standard Network Cable | LIU | Line Interface Unit- an module for generation E1/T1 Signals, both MBit/s (framed) and Clock (unframed) |
| CET | Central European Time | LNE | Local Network Extension, additional Ethernet Ports |
| CLI | Command Line Interface | MAC | Media Access Control |
| DB9 | Connector do type D-subminiature | MD5 | Message-Digest cryptographic hash function |
| DC | Direct Current | MESZ | Middle European Summer Time |
| DCF77 | Is a longwave time signal. DCF77 stands for D=Deutschland (Germany), C=long wave signal, F=Frankfurt, 77=frequency: 77.5 kHz. | MEZ | Middle European Time |
| DCFMARK | Single pulse with a programmable date and time | MIB | Management Information Base |
| DHCP | Dynamic Host Configuration Protocol | MRS | Multi Reference Source |
| DNS | Domain Name Server | MSF | Time signal transmitter in Anthorn, UK |
| DSCP | Differentiated Services Code Points | NIST | National Institute of Standards and Technology |
| DST | Daylight Saving Time | NMEA | Communication standard from National Marine Electronics Association |
| E1 | European digital transmission signal at 2.048 MHz used in telecommunication networks. | NTP | Network Time Protocol |
| E2E | End-to-end | NTPD | NTP Daemon |
| ETH | Ethernet | OSV | Original Shipped Version (Firmware) |
| FTP | File Transfer Protocol | OUT | Output |
| FW | Firmware | P2P | Peer-to-Peer |
| GE / GbE | Gigabit Ethernet | PLC | Programmable Logic Controller |
| GLONASS | GLOBal NAVigation Satellite System from Russian Aerospace Defense Forces | PLL | Phase Locked Loop |
| GND | Ground (Connector) | PPM | Pulse per Minute |
| GNSS | Global Navigation Satellite System (GPS, GLONASS, Galileo, Beidou) | PRP | Parallel Redundancy Protocol |
| GOAL | GPS Optical Antenna Link | PPS | Pulse per Second |
| GPS | Global Positioning System (USA) | PPH | Pulse per Hour |
| GSM | Global System for Mobile Communications | PTB | Physical - Technical Institute Braunschweig / Germany |
| HMI | Human-Machine Interface | PTP | Precision Time Protocol |
| HP | Horizontal Pitch - is a unit measure the horizontal width of rack mounted electronic equipment | RAM | Random Access Memory |
| HPS | High Performance Synchronization PTP/NTP/SyncE GBit module | RF | Frequency of radio waves, from 3kHz to 300GHz |
| HSR | High-availability Seamless Redundancy | RG58 | Standard coaxial cable used to connect an antenna and a receiver |
| HTTP | Hypertext Transfer Protocol | RJ45 | Ethernet Connector with 8 conductors |
| HTTPS | Hypertext Transfer Protocol Secure | RMC | Remote Monitoring Control |
| IEC | International Electrotechnical Commission | RoHS | Restriction of Hazardous Substances |
| IED | Intelligent Electronic Devices | RPS | Redundant Power Supply |
| IEEE | Institute of Electric and Electronic Engineers | RS232/485 | Serial port levels |
| IEEE 1588 | Protocol for high-precision synchronization in nanosecond | RSC | Redundant Switch Control unit |
| | | RX | Receiving Data |
| | | SBC | Single Board Computer |
| | | SDU | Signal Distribution Unit |

| | | | |
|---------|--|------|--|
| SHA-1 | Secure Hash Algorithm 1 | | AFNOR or IEEE1344 codes |
| SMB | Subminiature coaxial connector | T1 | North American telecommunication signal at 1.544 MHz frequency |
| SNMP | Simple Network Management Protocol | | Transmission Control Protocol |
| SNTP | Simple Network Time Protocol | TCP | Transistor-to-Transistor Logic |
| SMTP | Simple Mail Transfer Protocol | TTL | Data Transmission |
| SPS | Standard Positioning System | TX | Unit - is a unit measure the vertical height of rack mounted electronic equipment. |
| SSH | Secure SHell network protocol | U | User Datagram Protocol |
| SSU | Synchronization Supply Unit, specific clock used in telecommunication networks | UDP | Universal Mobile Telecommunications System |
| SSM | Sync Status Messages, clock quality parameters in telecommunication networks. | UMTS | Multitasking, multi-user computer operating system |
| ST | Bayonet-lock connector | UNIX | Universal Time Coordinate |
| Stratum | Value defines the NTP hierarchy | UTC | Virtual Local Area Network |
| SYSLOG | Standard for computer data logging | VLAN | Time signal radio station Fort Collins, Colorado (USA) |
| TACACS | Terminal Access Controller Access Control System | WWVB | |
| TCG | Time Code Generator | | |
| TCR | Time Code Receiver for IRIG A/B, | | |

4 Introduction

A LANTIME is a multi-purpose time and frequency synchronization solution with a flexible approach to support a large number of synchronization requirements in different applications and network environments. The system combines a powerful CPU with dedicated hardware like reference clocks or I/O modules, creating a powerful network appliance that supports almost all commonly used time and frequency synchronization protocols and signals.

The basic installation of a LANTIME Server is a very easy and straightforward process. After installing the hardware, the network address, the netmask and the default gateway have to be configured to be able to access the web GUI. If everything is set up correctly, as soon as the device is reachable over the network, it can start serving time via NTP and/or PTP.

In addition to the time sync protocols NTP and PTP, the LANTIME system supports a number of additional network protocols primarily used for remote management of the system: HTTP(S), FTP, SSH and Telnet. Remote configuration, status checks and other maintenance procedures like firmware updates or configuration backups can be controlled from any WEB browser. For security reasons, every protocol can be enabled or disabled for each configured IP address, allowing to reduce potential attack vectors and effectively control access to the device.

Status changes, alarms or other important events are logged in local log files and additionally can be forwarded to external SYSLOG servers. A number of notification protocols are supported to integrate the LANTIME system into already existing IT monitoring solutions. For example, SNMP traps or automatically generated e-mails are two potential options for notifying IT administrators about important events.

Installing multiple LANTIME devices in one network is a way to create redundancy for important network time synchronization services.

4.1 Network Configuration Concept

The LANTIME system supports a wide range of different network environments due to its flexible and powerful network configuration concept. A separation between physical and logical ("virtual") interface configurations covers almost all possible requirements for datacenters, telecommunication backhaul networks and industrial network environments.

Each LANTIME server has at least one physical ethernet interface which is provided by the CPU module (lan0). Additional network interfaces can be provided by network expansion cards (LNE or TSU cards) or on backplanes (depending on model). These additional physical interfaces can be used to provide synchronization services to multiple physical network segments, to separate management and synchronization networks or to combine multiple ethernet interfaces to form redundant connections ("bonding"). The 7th generation of LANTIME firmware (LTOS7) can manage up to 99 physical network interfaces as a theoretical maximum.

Configuration of IPv4 and IPv6 addresses is done based on logical interface configurations. Each logical interface is assigned to one physical ethernet port and can be configured to use one IEEE 802.1q VLAN ID. The current firmware version supports up to 99 logical interfaces per server and all of those could be theoretically assigned to a single physical port.

The network ports of TSU modules (for PTP and Hardware-NTP) are not providing this logical interface functionality and are limited, at least in the current firmware version, to one IPv4/IPv6 address and one VLAN ID per physical interface. Redundancy and connectivity to multiple network segments and VLANs can be achieved by adding multiple TSU cards in a system.

For each logical interface the available network services for synchronization (NTP, TIME, ..) and management (HTTP, HTTPS, SSH, SNMP, TELNET, ...) can be enabled/disabled individually. This allows to only provide synchronization on one IP address and remote access the unit for management tasks over a different IP address.

4.2 Additional Features

- external NTP timeserver
- free configuration of NTP: thereby MD5 authentication and access control via address & mask restriction
- extended menu guidance for configuration and monitoring via Telnet, SSH or serial terminal interface
- optional up to 3 RJ45/10/100 MBit Ethernet interfaces
- extended HTTP statistic support with long-term graphic and access statistic to NTP
- alarm messages can be displayed on external large display VP100/20/NET
- USB memory stick slot for extended functionality: software update, transfer of secure certificates, log files and configurations, keypad locking

4.3 User Interface

- Terminal connection via serial interface, status LED
- Web browser interface with graphical statistic of the one-day cycle offsets
- Telnet or Secure Shell Login for password protected operation of the Linux operating system
- FTP access for updating the operating system and downloading log files
- Simple Network Management Protocol for automatically SNMP-Traps in case of alarm
- SYSLOG messages can be passed to different computers
- Configurable e-mail notification
- Simulation of a synchronous radio clock in order to operate without antenna

4.4 Input and Output Options

- Additional Ethernet RJ45 connectors available (eight in 3U housing, four in 1U housing and eight additional connectors in HS - XL railmount housing)
- Frequency and pulse outputs via BNC connectors (e.g. 10 MHz, 2.048 MHz, PPS)
- Higher free running accuracy with optional oscillators (OCXO)
- IRIG-B outputs
- ANZ14NET or VP100/20/NET as display connected via network

Additional Ethernet RJ45 connectors available:

| System Type | CPU-C05F1 | CPU-C15G2 (Q7) |
|---------------|------------------------------|------------------------------|
| LANTIME M4000 | up to 25 (+24) Network Ports | up to 26 (+24) Network Ports |
| LANTIME M3000 | up to 25 (+24) Network Ports | up to 26 (+24) Network Ports |
| LANTIME M1000 | up to 17 (+16) Network Ports | up to 18 (+16) Network Ports |
| LANTIME M500 | up to 9 (+8) Network Ports | up to 10 (+8) Network Ports |
| LANTIME M900 | up to 9 (+8) Network Ports | |
| LANTIME M600 | up to 5 (+1) Network Ports | |
| LANTIME M400 | up to 5 (+4) Network Ports | |
| LANTIME M300 | up to 6 (+4) Network Ports | |

4.5 The Network Time Protocol (NTP)

The NTP protocol has been invented in the 1980's by Dave L. Mills at the University of Delaware. The ambition was to achieve the highest possible time synchronization accuracy for computers across the network. The protocol and related algorithms have been specified in several RFCs.

The public domain software package called NTP is the reference implementation of this protocol. Since the original implementation NTP has been enhanced and is now widely used around the world. The protocol supports an accuracy of time down to nanoseconds. However, the real accuracy which can be achieved also depends on the operating system and the network performance.

The current NTP v4 protocol version has been standardized by the IETF, and the basic format of the network packets is compatible with earlier NTP versions, so current NTP implementations can be used together with older versions, unless specific NTP v4 features are being used. In addition to NTP there's also a simplified version called SNTP (Simple Network Time Protocol) which uses the same TCP/IP UDP packet structure like NTP but due to the simpler algorithms, it usually provides only reduced accuracy and is thus mostly used for simple clients. The NTP package contains a background program (daemon or service) which synchronizes the computer's system time to one or more external reference time sources which can be either other devices on the network, or a hardware reference time source connected to the computer.

Additionally, the NTP distribution contains programs which can be used to control or monitor the time synchronization status, and a complete set of documentation in HTML format.

Learn more about the Network Time Protocol in our white paper "Computer Time Synchronization Concepts" chapter 6: <https://www.meinbergglobal.com/english/info/#whitepaper>

4.5.1 Computer Platforms Supported by NTP

NTP's native operating system is UNIX. Today, however, NTP runs under many UNIX-like systems, and NTP v4 has also been ported to Windows. It can be used under Windows NT, Windows 2000, and newer Windows versions up to Windows Vista, Windows 7 / Windows 8 and Windows Server 2008 / 2012.

The standard NTP distribution can **not** be run under Windows 3.x and Windows 9x/ME because there are some kernel features missing which are required for precision time keeping. For Windows 9x/ME and other platforms which are not supported directly by the NTP package there are some NTP or SNTP programs available on the internet. An overview of available programs can be found on the NTP support home page: <http://support.ntp.org/bin/view/Main/ExternalTimeRelatedLinks>

4.6 Option: Precision Time Protocol (PTP) / IEEE 1588

Precision Time Protocol (PTP or IEEE 1588) is a time synchronization protocol that offers sub-microsecond accuracy over a standard Ethernet connection. This accuracy can be achieved by adding a hardware timestamping unit to the network ports that are used for PTP time synchronization. The timestamping unit captures the exact time when a PTP synchronization packet is sent or received. These timestamps are then taken into account to compensate for transfer delays introduced by the Ethernet network.

In PTP networks there is only one recognized active source of time, referred to as the Grandmaster Clock. If two or more Grandmaster Clocks exist in a single network, an algorithm defined in the PTP standard is used to determine which one is the „best“ source of time. This „Best Master Clock“ algorithm must be implemented on every PTP/IEEE1588 compliant system to insure that all clients („Slave Clocks“) will select the same Grandmaster. The remaining deselected Grandmaster Clocks will „step back“ and enter a passive mode, meaning that they do not send synchronization packets as long as that is being done by the designated Grandmaster.

The existing network infrastructure components play a big role in a PTP network and directly influence the level of accuracy that can be achieved by the clients. Asymmetric network connections degrade the accuracy, therefore classic layer 2 and 3 Ethernet switches with their “store and forward” technology are not suitable for PTP networks and should be avoided. With activating the HQ-Filter (see chapter HQ-Filter) the Jitter can be eliminated. Simple Ethernet hubs with fixed pass-through times are not a problem. In large networks, special switches with built-in PTP functionality help to maintain high accuracy even over several subnets and longer distances. These components act as "Boundary Clocks" (BC) or "Transparent Clocks" (TC). They compensate their internal packet processing times by using timestamping units on each port. When acting as a Boundary Clock, they synchronize to the Grandmaster clock, and in turn act as a Master to the other subnets they are connected to. When acting as a Transparent Clock, then the "residence time" of the Masters' Sync-Packet is measured and added to the packet as a correction value. Internally the PTP timescale TAI (see chapter Timescale in Global Parameters).

4.6.1 General Information

The internal PTP card acts as a network interface card (10/100MBit) with an integrated hardware time stamp unit to obtain time stamps in PTP compatible networks. In conjunction with a single board computer running the PTP protocol stack and a reference time source (PTP master only) the module is capable of building a PTP Master or Slave system:

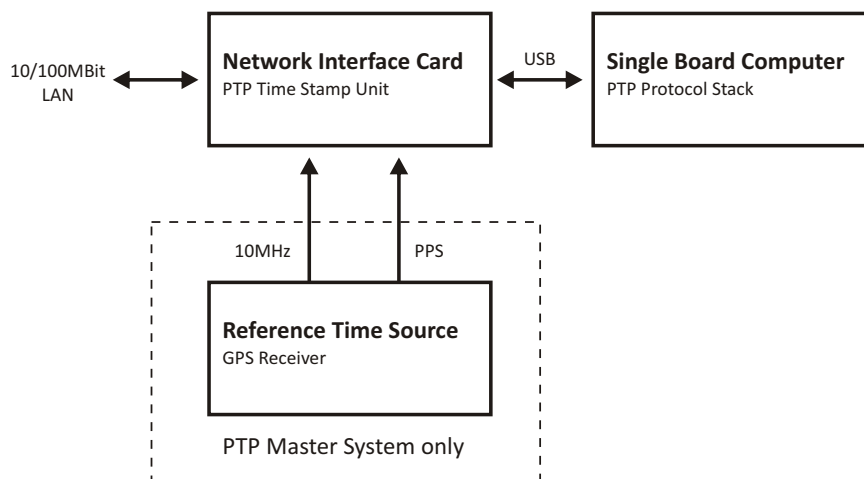

The Time Stamp Unit, integrated in an FPGA (Field Programmable Gate Array, a programmable logic device), checks the data traffic on the MII-interface between the PHY receiver (physical connection to the network) and the Ethernet controller (MAC) on the PTP module. If a valid PTP packet is detected, the time stamp unit takes a time stamp of that packet which is read by a single board computer (SBC) running the PTP software. The configuration and status traffic between the PTP board and main SBC is done over a USB connection.

4.6.2 Functionality in Master Systems

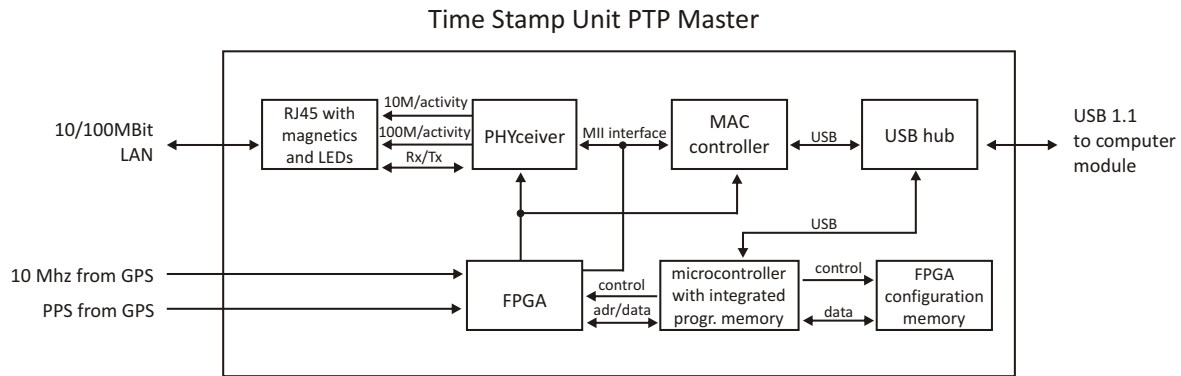

After power up, the module accepts the absolute time information (PTP seconds) of a reference time source (e.g. GPS reference clock) only once, and the PTP nanoseconds are set to zero. If the oscillator frequency of the reference time source has reached its nominal value, the nanoseconds are reset again. This procedure leads to a maximum deviation of 20 nsec of the pulse per second (1PPS) of the PTP Master compared to the 1PPS of the GPS reference clock. The reference clock of the PTP board's time stamp unit (50 MHz) is derived from the GPS disciplined oscillator of the reference time source using a PLL (Phase Locked Loop) of the FPGA. The achieves a direct coupling of the time stamp unit to the GPS system.

4.6.3 Functionality in Slave Systems

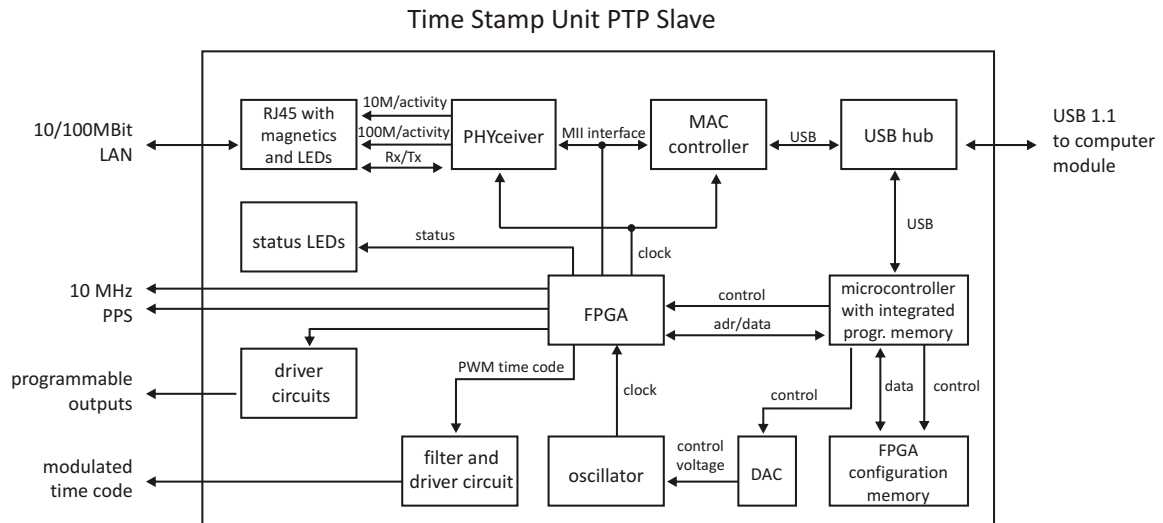

After decoding valid time information from a PTP Master, the system sets its own PTP seconds and nanoseconds accordingly. The PTP offset calculated by the PTP driver software of the single board computer is used to adjust the master oscillator of the TSU-USB. This allows the PTP Slave to generate very high accuracy output signals (10 MHz/1PPS/IRIG).

4.6.4 PTPv2 IEEE 1588-2008 Configuration Guide

Setting up all devices in a PTP synchronization infrastructure is one of the most important parts in a network time synchronization project. The settings of the involved Grandmaster clocks as the source of time and the end devices ("Slaves") have to match in order to allow them to synchronize and avoid problems later, when the PTP infrastructure is deployed to production environments. In addition to that, the use of PTP aware network infrastructure components, namely network switches, introduces another set of parameters that have to be harmonized with the masters and slaves in a PTP setup.

It is therefore very important to start with making decisions how the to-be-installed PTP synchronization solution should operate, e.g. should the communication between the devices be based on multicast or unicast network traffic or how often should the masters send SYNC messages to the slaves.

This chapter lists the most important options and their implications on a synchronization environment in general. A detailed explanation of the configuration settings within the LANTIME configuration interfaces can be found later within this documentation.

4.6.4.1 General Options

The following general mode options have to be decided before deploying the infrastructure:

- 1) Layer 2 (Ethernet) or Layer 3 (UDP/IPv4) connections
- 2) Multicast or Unicast
- 3) Two-Step or One-Step Operation
- 4) End-to-End or Peer-to-Peer Delay Mechanism

The above options need to be defined for the whole setup, if devices do not stick to the same settings, they will not be able to establish a working synchronization link.

4.6.4.2 Network Layer 2 or Layer 3

PTP/IEEE 1588-2008 offers a number of so-called mappings on different network communication layers. For Meinberg products you can choose between running PTP over IEEE 802.3 Ethernet connections (network Layer 2) or UDP/IPv4 connections (Layer 3).

Layer 3 is the recommended mode, because it works in most environments. For Layer 2 mode the network needs to be able to provide Ethernet connections between master and slave devices, which is often not the case when your network is divided into different network segments and you have no layer 2 routing capabilities in your network infrastructure.

The only benefit of using Layer 2 mode would be a reduced traffic load, because the transmitted network frames do not need to include the IP and UDP header, saving 28 bytes per PTP packet/frame. Due to the fact that PTP is a low traffic protocol (when compared to other protocols), the reduced bandwidth consumption only plays a role when low-bandwidth network links (e.g. 2Mbit/s) have to be used or in pay-per-traffic scenarios, for example over leased-line connections.

4.6.4.3 Multicast or Unicast

The initial version of PTP (IEEE 1588-2002 also known as PTPv1) was a multicast-only protocol. Multicast mode has the great advantage that the master clock needs to send only one SYNC packet to a Multicast address and it is received by all slave devices that listen to that multicast address.

In version 2 of the protocol (IEEE 1588-2008) the unicast mode was introduced in addition to the multicast mode. In unicast mode, the master has to send one packet each to every slave device, requiring much more CPU performance on the master and producing orders of magnitudes more traffic.

On the other hand, some switches might block multicast traffic, so that in certain environments, Unicast mode has to be used.

4.6.4.4 Two-Step or One-Step

The PTP protocol requires the master to periodically send SYNC messages to the slave devices. The hardware time stamping approach of PTP requires that the master records the exact time when such a SYNC packet is going on the network wire and needs to communicate this time stamp to the slaves. This can be achieved by either sending this time stamp in a separate packet (a so-called FOLLOW-UP message) or by directly manipulating the outgoing SYNC message, writing the hardware time stamp directly into the packet just before it leaves the network port.

4.6.4.5 End-To-End (E2E) or Peer-To-Peer (P2P) Delay Measurements

In addition to receiving the SYNC/FOLLOWUP messages a PTP slave device needs to be able to measure the network delay, i.e. the time it took the SYNC message to traverse the network path between the master and the slave. This delay is required to correct the received time information accordingly and it is measured by the slave in a configured interval (more about the message intervals later). A delay measurement is performed by sending a so-called DELAY_REQUEST to the master which timestamps it and returns the timestamp in a DELAY_RESPONSE message.

IEEE 1588-2008 offers two different mechanisms for performing the delay measurements. A slave can either measure the delay all the way to the master, this is called End-To-End (or E2E in short) or to its direct network neighbors (which would in almost all cases be a switch – or two in a redundant setup), using the Peer-To-Peer delay measurement mechanism (P2P). The delay measurements of all links between the master and the slave are then added and accumulated while a SYNC packet is traversing the network.

The advantage of this method is that it can dramatically reduce the degradation of accuracy after topology changes. For example: in a redundant network ring topology the network delay will be affected when the ring breaks open and network traffic needs to be redirected and flows into the other direction. A PTP slave in a sync infrastructure using E2E would in this case apply the wrong delay correction calculations until it performs the next delay measurement (and finds out that the network path delay has changed). The same scenario in a P2P setup would see much less time error, because the delay of all changed network links were already available.

The drawback: the P2P approach requires that all involved PTP devices and all switches support this mechanism. A switch/hub without P2P support would in the best case simply pass the so-called PDELAY messages through and as a result degrade the accuracy of the delay measurements. In the worst case it would block/drop the PDELAY messages completely, which effectively would result in no delay measurements at all.

So, E2E is the only available choice if you are running PTP traffic through non-PTP-aware switches. It is a reasonable choice if you are not using redundant network topologies or can accept that the delay measurements are wrong for a certain amount of time.

4.6.4.6 Message Rate Settings

The decision between the different general mode options is mainly dictated on the network environment in which the PTP infrastructure is installed. In addition to the mode selection, a number of intervals for certain types of PTP network messages needs to be defined. In most cases, the default values as defined in the standard are a safe bet, but there are applications and scenarios where a custom message rate is required.

A possible example is a situation where the PTP infrastructure is integrated within an environment with high network load. In this case, the PTP packets can be affected by the effect of packet delay variation (PDV). An increase of the PTP message rate(s) can avoid synchronization problems due to packet queuing within non-PTP compliant switches which might cause false measurements. At higher rates, these false measurements can be detected and corrected faster as compared to lower rates at the cost of increased traffic.

The message rates for the following message types can be changed:

- 1) ANNOUNCE messages
- 2) SYNC/FOLLOWUP messages
- 3) (P)DELAY_REQUEST messages

4.6.4.7 ANNOUNCE Messages

These PTP messages are used to inform the PTP network participants about existing and available master clock devices. They include a number of values that indicate the potential synchronization accuracy.

The procedure used to decide which of the available devices (that could become masters) is selected is called the "best master clock algorithm" (BMCA). The values that are used in this BMCA are read from the ANNOUNCE messages that potential masters send out periodically.

The rate at which these messages are sent out are directly affecting the time that is required by a slave device to select a master and to switch to a different master in case the selected one fails.

Multiple devices can simultaneously transmit ANNOUNCE messages during periods in which no master has been selected (yet). This happens for example when a PTP network is powered up, i.e. all devices are starting to work at the same time. In this case all devices that consider themselves (based on their configuration and status) being capable of providing synchronization to all the other PTP devices will start to send out ANNOUNCE messages. They will receive the other candidates' ANNOUNCE messages as well and perform the BMCA. If they determine that another candidate is more suitable to become the master clock, they stop sending ANNOUNCE messages and either become slave devices or go into "PASSIVE" mode, waiting for the selected master to stop sending ANNOUNCE messages. This is determined to be the case when no ANNOUNCE message is received within 3 ANNOUNCE message intervals.

As an example, if the ANNOUNCE interval has been configured to be 2 seconds (one message every 2 seconds, the default value), the master is considered to have failed when no message has been received for 6 seconds.

In order to choose a master (a backup master clock or the primary one during initialization) the devices require to receive at least two consecutive ANNOUNCE messages. Continuing our example, it would take the 6 seconds to determine that the current master has failed and another 4 seconds to select the new one. That means an ANNOUNCE interval of 2 seconds translates into at least 10 seconds of "switching time" and 4 seconds of "initial master clock selection time". So, choosing a shorter ANNOUNCE message interval will allow a faster switching to a backup master clock, but it can lead to false positives when the chosen interval is too short for the network environment.

4.6.4.8 SYNC/FOLLOWUP Messages

The selected master clock sends out SYNC (and, in Two-Step environments, the corresponding FOLLOWUP) messages in a configured interval. This interval (default value is one SYNC/FOLLOWUP packet every second) determines how often the slave devices receive synchronization data that allows them to adjust their internal clocks in order to follow the master clock time. Between receiving two SYNC messages, a slave clock runs free with the stability determined by its own internal time base, for example a crystal oscillator. One important factor for deciding on the SYNC interval is the stability of this oscillator. A very good oscillator requires a lower SYNC message rate than a cheaper, low-accuracy model. On the other hand you directly affect the required network bandwidth by changing the SYNC interval.

For Meinberg slave devices, the default one-SYNC-every-second setting is more than enough to achieve the highest possible synchronization accuracy.

4.6.4.9 (P)DELAY_REQUEST Messages

As explained in the General Mode Options chapter (see the “End-To-End or Peer-to-Peer” section), the delay measurements are an important factor for achieving the required accuracy. Especially in E2E mode, the network path delay measurements play a crucial part in the synchronization process. Per default, the slaves will perform delay measurements every 8 seconds, resulting in sending and receiving one packet. This can be increased in case the network path delay variation in the network is relatively large (i.e. the time it takes for the SYNC message to reach the slave varies a lot) or the slave devices have to tightly follow the master and adjust their time base (oscillator) very often due to its instability.

Meinberg slave devices will limit the effect of an outdated path delay measurement by using filters and optimized PLL algorithms. This avoids that a clock “jumps around” and basically monitors the time difference to the master clock carefully for a certain amount of time before adjusting its own clock. With a low cost time base this is not possible, because the instability (i.e. temperature-dependent drift and overall short term stability/aging effects) and therefore these slaves would require to perform as many delay measurements and receive as many SYNC/FOLLOWUP messages as possible.

For P2P mode the delay request interval is not as critical, simply because the delay variation on a single-hop link (i.e. from your slave device to its switch) is very stable and does not change dramatically in typical environments.

Current firmware versions of Meinberg Grandmaster clocks (V5.32a and older) do not offer changing the Delay message rate in Multicast mode, it is fixed to one delay request every 8 seconds. Since this is actually a value that is transmitted in the DELAY_RESPONSE message as a maximum value, the slave devices are not allowed to perform delay measurements more often.

4.6.4.10 HQ Filter

If you use non PTP aware switches in a network where PTP should be used then the timing accuracy of the offset depends on the characteristic of the switches. Non PTP switches will cause time jitters (due to non deterministic delays in each path direction) in PTP measurement. In this section, the term "jitter" is used to describe the maximum deviation of the measured offsets around a certain mean value. This time jitter of standard non-PTP compliant switches can be in the range of 100 ns up to 10000 ns. When using routers this jitter can be even higher. To reduce this time jitter the HQ filter can be activated to achieve a better PTP slave synchronization quality. With Layer2 switches the accuracy can be achieved in the range of submicro seconds. Also jitter caused by high network load and faulty measurements will be eliminated

Functionality

After activating the HQ-Filter some PTP measurements will be done first without controlling the timing of the PTP slave. This phase will be indicated by an extra hint "init" in the current status of the PTP slave. During this phase the maximum jitter of the PTP offset, the path delay and the current drift of the internal oscillator will be calculated by statistical methods. The only filter parameter which can be set by the user is the **estimated accuracy** which will set the maximum expected range of the incoming time jitter. All input values that are out of this range will be dropped. The maximum jitter of the input will be updated continuously during normal operation. By default **estimated accuracy** will be set to 1s to determine the maximum jitter automatically.

PDSC

PDSC means "Path Delay Step Compensation". The PDSC feature tries to eliminate jumps of the PTP path delay, so that there will be no effect on the timing accuracy. Such a jump of the PTP path delay (which should be usually constant) will be caused by changing the topology of the PTP network which could happen in SDH networks for example. The change of the PTP path delay is only detected, if the step is larger than the measured time jitter. This feature is an extension of the HQ-Filter and therefore the HQ-Filter has to be activated.

5 Unboxing

After unpacking the LANTIME time server, please check the contents for completeness – regarding to the included packing list.

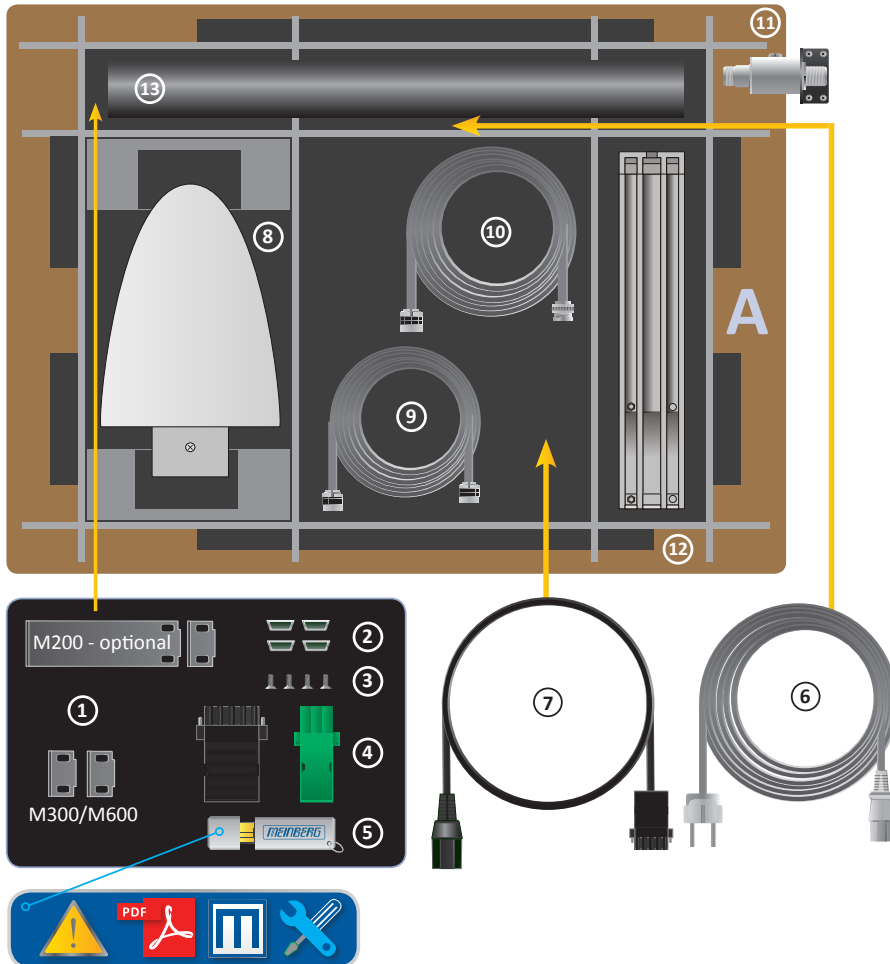

A LANTIME Package Contents

1. Assembly brackets for 19 Inch rack mounting (optional for LANTIME M200)
2. Protection spacer (M200 / M300 / M600)
3. Screws for brackets (M200 / M300 / M600)
4. 3-pin DFK connector or 5-pin DFK connector (additional connector in case of AC/DC or DC power supply)
5. USB stick with software and documentation
6. Power cord (only in case of AC power supply)
7. Option: power cable with 5-pin connector

Only with delivered Antenna

8. Antenna
9. Optional: cable for surge voltage protector
10. Antenna cable
11. Optional: surge voltage protector with bracket
12. Brackets for pole or wall mounting
13. Pole for antenna mounting (GPS Antenna)

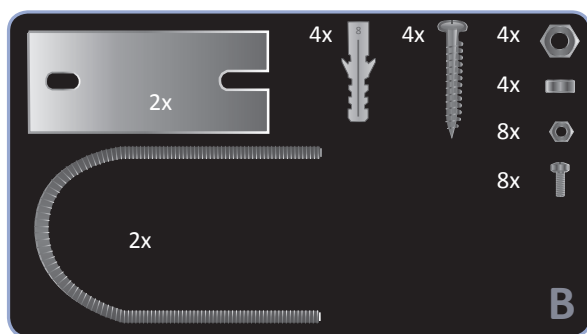

B Mounting Kit for GPS Antenna
(wall or pole mounting)

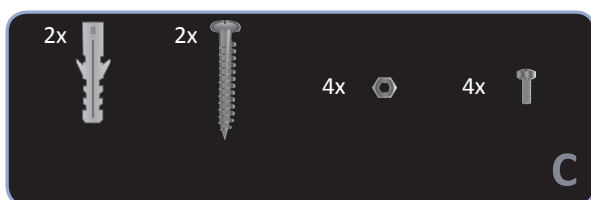

C Mounting Kit for Long Wave Antenna
(wall mounting)

Note: Please read the safety instructions and the manual carefully to familiarize yourself with the safe and proper handling of electronic devices. The product documentation can be found on the USB Flash Memory.

6 LANTIME Installation

- Connecting the LANTIME
- Entering the IP Address
- Connecting the Antenna
- Configuration via the Web Interface

Connecting the LANTIME

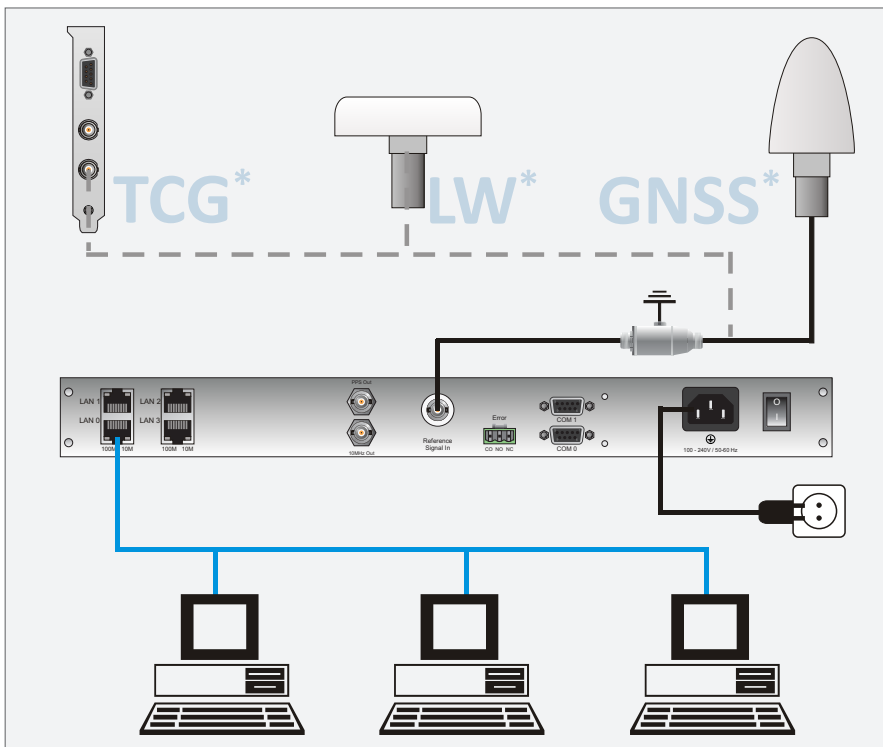

Figure: LANTIME Connection diagram * TCG = Time Code Generator, LW = Long Wave Receiver, GNSS = Global Navigation Satellite System

Make sure that the power switch (if available) is in the "0" position (off), and plug the power cord into the power socket of your LANTIME. Then connect the device to your computer network using a suitable network cable. After switching on power, the following message is displayed:

```

MEINBERG LANTIME
is booting ...
please wait ...
.....
    
```

After running a number of power-on self tests, the time server is in operation mode and the main screen appears.

Entering the IP Address

Initial installation requires setting up an IP address, netmask and (in most network environments) a default gateway. To get an overview of the current configuration, press F2. Press F2 again to enter the Network SETUP screen:

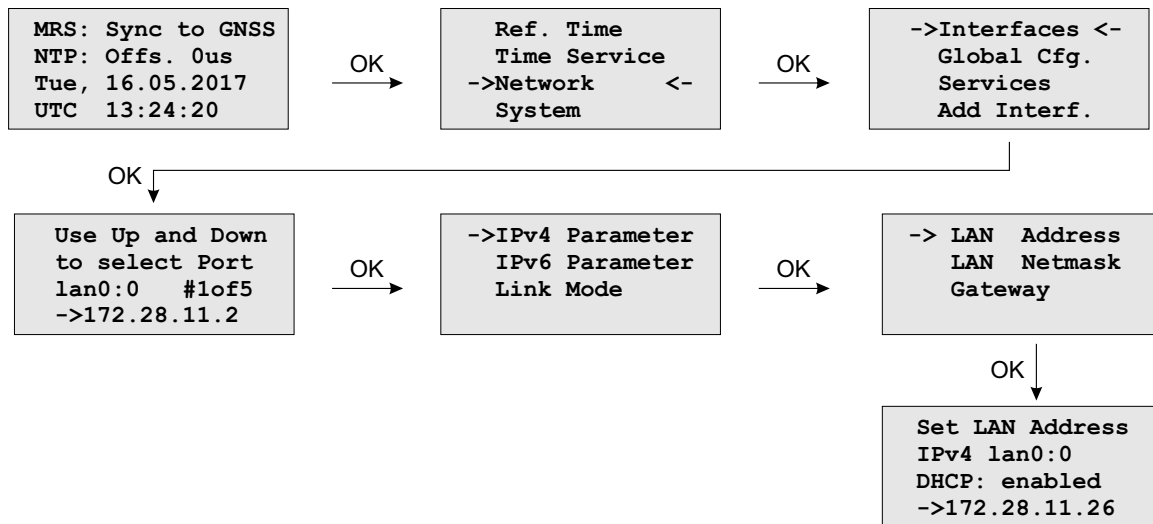

Navigate to "Interfaces" using the arrow keys and press OK to change to the configuration menu of the connected network interface. You can select the network port with the "Down" and "Up" arrow keys (↓ | ↑).

Entering the IP Address manually (not using DHCP)

Deactivate DHCP and set up a valid IP address, netmask and (if required) a default gateway. This can be done by selecting a field with the arrow keys. Then press OK to switch to edit mode.

The cursor can be moved using the ← | → arrow keys, the value underneath the cursor can be modified with ↓ | ↑. Confirm your changed values with OK and F2.

Connecting the Antenna

Connect the antenna cable with the antenna socket of your LANTIME. In case of a short-circuit, the following message appears in the display:

```

ANTENNA
SHORT-CIRCUIT
DISCONNECT POWER
!!!
  
```

In such a case, switch off the device and check the antenna cable. Instructions for installing the antenna are included in the corresponding chapter „Mounting the Antenna“ of the manual which is available in the „Manual“ folder of the USB flash drive.

Configuration via the Web Interface

The system configuration can now be changed via the network using a WEB browser or a Telnet / SSH client.

Connect to the web interface by entering the IP address of the LANTIME into the address field of your web browser:

1. Accessing the Web Interface
Type in the IP of your LANTIME into the address field `http://xxx.xxx.xxx.xxx`
2. LOGIN
user: root
password: timeserver

7 Security User Guide / Security Advisories

This Chapter describes the configuration of a LANTIME series operating system (LTOS) in terms of security features. It is divided in the following sections: general overview, securing the management, securing the time services and additional information about event log delivery. Finally, some advisories for the update process of a LANTIME are given.

The general knowledge about public key infrastructures, RSA, symmetric keys and the protocols SSL, SSH, NTP and SNMP is assumed.

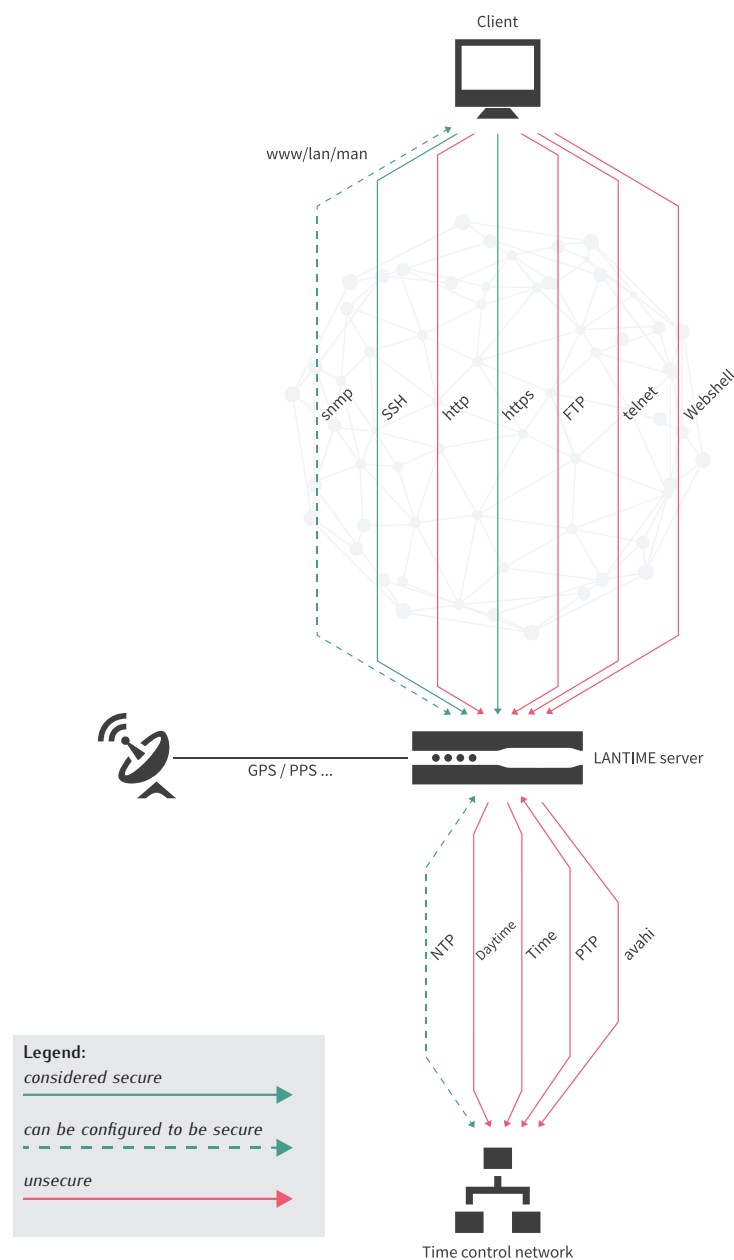

Figure 7.1: LANTIME Services

7.1 General Informations

Before starting with the configuration, take a look at Figure 7.1 to identify the possible services that can be configured to be secure.

In general, a secure management of the LANTIME is possible with SSH, HTTPS and SNMP. If the configuration via SNMP is desired, the usage of version 3 is the only way to get a secure connection to manage the system. It is a good practice to deactivate all services that are not in use, to minimize the attack surface. So if possible, only enable one of the services (SNMP has not the full configuration support, but you can activate the other services over SNMP)!

The delivery of secured time information is only available for NTP. Please note, that the NTP protocol only supports integrity and authenticity but no confidentiality. PTP does not currently support IT security functions. These are only planned for the next protocol standard. For this reason, you must still use NTP to ensure secure time synchronization.

Another important advisory is to use the newest browsers and service clients to support the selection of the best security algorithms for server and client communication. A timely installation of updates can also close known vulnerabilities and minimize the risk of a successful attack.

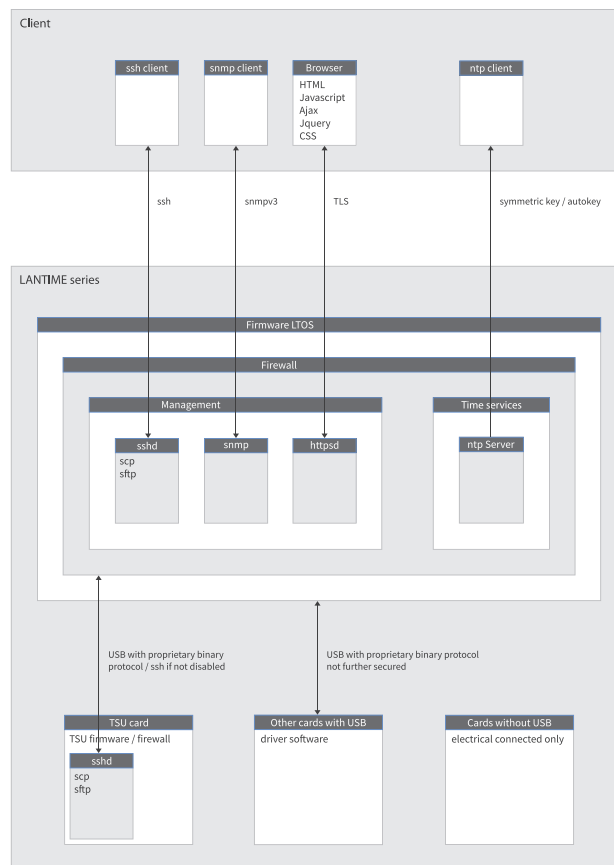

Figure 7.2: The secure protocols in detail

The current firmware version LTOS V7 of Meinberg's TSU boards no longer offers the ability to establish an SSH connection via network. Access is only allowed via the CPU module of the LANTIME. It is still possible to completely disable the SSH service of a TSU card as shown in Figure 7.3.

The screenshot shows the configuration page for 'Interface 01 (Slot: MRI1)'. The 'Network' tab is active. The 'Monitor Interface' checkbox is checked. The 'Net Link Mode' is set to 'Autoneg'. The 'Hostname' is 'PTPv2' and 'Domainname' is empty. 'Nameserver 1' and 'Nameserver 2' are both '0.0.0.0'. 'Enable DHCP-Client' is set to 'No'. 'TCP/IP Address' is '172.27.19.77', 'Netmask' is '255.255.0.0', and 'Default Gateway' is '0.0.0.0'. 'IPv6 Mode' is 'Static' and 'IPv6 Address' is 'bad:babe:a9a3/64'. 'IPv6 Multicast Scope' is 'FF01 - Interface-Local Scope'. 'Enable VLAN Option' is unchecked. 'VLAN-Tag (0-4094)' is '0' and 'Priority' is '0'. The 'Disable SSH Service' checkbox is checked and highlighted with a green box. 'DSCP PTP Classification' is 'CUSTOM 00 (HEX: 00)' and 'Multicast TTL' is '5'.

Figure 7.3: Disable SSH on TSU

| Services | Confidentiality | Integ. | Avail. | Auth. | Account. |
|----------|-----------------|--------|--------|-------|----------|
| https | x | x | 0 | x | (x) |
| ssh | x | x | 0 | x | (x) |
| ntp | - | x | 0 | x | (x) |

Table: Security targets

The table shows the security goals of the protocols in short. The accountability is given through a detailed syslog of the actions performed by every user or process. However, the log files can be changed later by root or super users. For this reason, the system cannot guarantee the non-repudiation.

The most, possible availability of the services is realized through current updates and IP banning. For more protection, implement web application firewalls and traditional firewalls in the network, that are able to identify and prevent DOS/DDOS attacks.

With all changes to the configuration keep in mind, that they are lost after a reboot or could be discarded by other admins or super users, if they are not saved in the startup configuration.

7.2 Optimizing Management Access Security

The most secure way to configure a LANTIME is to connect the client directly to the LANTIME until only secure channels are left available. This manual uses the Web Interface over SSL as an example.

Once a reference clock is connected and the LANTIME has completed the subsequent start-up process, an IP address can be set via the front panel (see chapter "LTOS Management and Monitoring → Via Web GUI → Network"). Once done, a connection can be established to the Web Interface via the configured IP address, for which the default login credentials should be used to log in:

User: *root*

Password: *timeserver*

Once you have successfully logged in, you should first verify if a new Firmware Version is available (refer to the chapter "Firmware/Software Update" for instructions on how to perform an update). Once any update has been installed, you should generate or inject an SSL certificate—a new certificate will be used in this example. Figure 7.4 shows the button used to launch the generation process.

The screenshot shows a web interface titled "Certificates" with a dropdown arrow. Below the title are three tabs: "CSR", "Certificates", and "CA Certificates". Under the "Certificates" tab, there are three buttons: "Generate SSL Certificate" (highlighted in green), "Show SSL Certificate", and "Download SSL Certificate". Below these buttons is a section for "Optional Passphrase" with a text input field and a lock icon. At the bottom, there is a file selection area with a "Durchsuchen..." button, the text "Keine Datei ausgewählt.", and two buttons: "Upload SSL Certificate" (highlighted in green) and "Paste SSL Certificate".

Figure 7.4: Generating an SSL Certificate - Step 1

The next step is to enter the information required for the certificate (refer also to the chapter "LTOS Management and Monitoring → Via Web GUI → Security"). The form is displayed as shown in Figure 7.5. A key length of 2048 bits or higher should be used, and a shorter validity period for certificates is preferable to longer periods. This example uses three years, which is a good trade-off between minimizing the validity period and keeping management costs at an acceptable level.

The screenshot shows a form titled "Generate SSL Certificate". It contains the following fields and values:

- Country Name (2 letter code): DE
- State or Province: Some State
- Locality Name: Some City
- Organization Name: Meinberg
- Organizational Unit: Support
- Subject Alternative Name: LT-HARVEY-29-105.local
- Email Address: info@meinberg.de
- Period of Validity: 3 Years
- Key Length: 2048

Below the form, there is a red note: "Please note: depending on the selected key length this could take several minutes. Use the appropriate show button to prove that your certificate/CSR was created successfully".

Figure 7.5: Generating an SSL Certificate - Step 2



Figure 7.6: |Displaying the Generated SSL Certificate

The generated certificate can be displayed using the "Show SSL Certificate" button, and the information shown here should be used to compare the new certificate with the certificate provided by your browser when an HTTPS connection is next established with the LANTIME—the two certificates should be identical! Figure 7.7 illustrates the import process. The numbers in the image show the order in which the actions should be performed—Step 4 shows the information that should be compared with the certificate previously downloaded from the LANTIME. If both certificates are identical, you can proceed with Step 5 to confirm the trustworthiness of the LANTIME certificate. Modern browser configurations will display a warning that a connection is insecure when using a self-signed certificate, and for this reason we recommend establishing a public-key infrastructure to suppress the warning. You should also ensure that you use a Subject Alternative Name (SAN), as modern browsers also check for this. To this end, you can generate, download, and sign a certificate request and re-upload the signed certificate via the web frontend as shown in Figure 7.4.

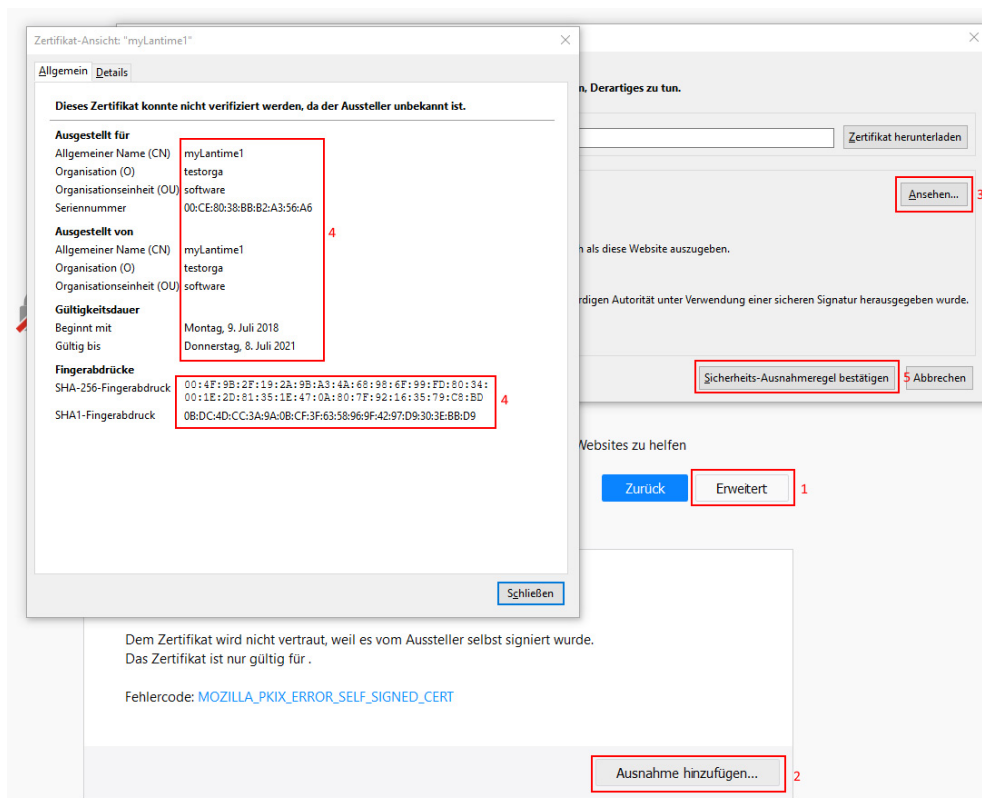

Figure 7.7: Importing the New SSL Certificate into the Browser

Once a connection can be established over HTTPS, you can disable all of the other unused services as shown in Figure 7.8. It is worth noting that this example also only provides HTTPS access via a single network interface to show how scenarios such as a dedicated network for management access are also possible.

| Network Services | | | | | | | | | | | | |
|------------------------|-------------------------------------|-------------------------------------|-------------------------------------|--------------------------|-------------------------------------|--------------------------|--------------------------|--------------------------|--------------------------|--------------------------|-------------------------------------|---|
| Service | NTP | HTTP | HTTPS | TELNET | SSH | SNMP | FTP | TIME | DAYTIME | WEBSHELL | MMS | |
| Interface 01 - lan0:0: | <input checked="" type="checkbox"/> | <input type="checkbox"/> | <input checked="" type="checkbox"/> | <input type="checkbox"/> | <input checked="" type="checkbox"/> | <input type="checkbox"/> | <input type="checkbox"/> | <input type="checkbox"/> | <input type="checkbox"/> | <input type="checkbox"/> | <input checked="" type="checkbox"/> | + |
| Interface 02 - lan0:1: | <input checked="" type="checkbox"/> | <input type="checkbox"/> | <input type="checkbox"/> | <input type="checkbox"/> | <input type="checkbox"/> | <input type="checkbox"/> | <input type="checkbox"/> | <input type="checkbox"/> | <input type="checkbox"/> | <input type="checkbox"/> | <input type="checkbox"/> | + |
| | - | + | - | + | - | + | + | + | + | + | + | + |
| Current State: | <input checked="" type="checkbox"/> | <input checked="" type="checkbox"/> | <input checked="" type="checkbox"/> | <input type="checkbox"/> | <input checked="" type="checkbox"/> | <input type="checkbox"/> | <input type="checkbox"/> | <input type="checkbox"/> | <input type="checkbox"/> | <input type="checkbox"/> | <input checked="" type="checkbox"/> | |

Figure 7.8: Disabling Services

For the next step a second superuser (other than root) is required. Create a new superuser as described in Chapter 7.3. Once the new superuser has been created, log in with the corresponding account credentials and disable root login as described under "Security → Login/Access → Disable Root Login". If necessary, you can also disable the front panel, USB port, and local console as described under "Security → Front Panel" and shown in Figure 7.9. It is also possible to limit Web Interface access to 'whitelisted' IP addresses (note: Remote Access Control is not effective for SSH connections).

Front Panel

- Lock Front Panel
- Disable USB Port
- Automatically save and apply configuration which was uploaded via USB interface
- Disable local console
- Automatically activate firmware which was installed via USB interface

Figure 7.9: Disabling the Front Panel and USB Port

The timeout for web sessions is configured via the "Security" tab in the Web Interface under "Login/Access", which is shown in Figure 7.10—the shorter the timeout, the lesser the security risk.

Login/Access

Disable Root Login

Remote Access Control

Shell Timeout:

Web Timeout:

Enable Bruteforce detection

Unlock time: minutes

Num tries:

Silent mode

Figure 7.10: Setting the Web Interface Timeout

Brute-force attacks on password phrases can be impeded by enabling "Security → Login → Enable Bruteforce Detection". If a lockout time and a number of attempts is set, accounts will be locked out for that amount of time after the specified number of failed login attempts. It is also possible to enable Silent Mode so that the lockout status of a user account is not disclosed over the SSH interface—this prevents hackers from harvesting a list of valid users, but may also confuse users who accidentally enter the wrong account details too often and are thus unable to subsequently log in using correct credentials during the lockout period.

It is also possible for locked-out users to be notified over the channels configured under "Notification → Notification Events → Faillock: user banned". *syslog-auth.log* also always lists the messages about banned users.

If all of these steps are properly followed, the LANTIME will be configured in such a way that enables it to be managed and monitored securely. Remember to check that the IP configuration and Remote Access Control settings work properly in your live network environment.

You can also optionally configure SNMP to manage your LANTIME. The security options are provided under "Security → SNMP". Figure 7.11 shows the corresponding form.

To establish a secure connection via SNMP, Version 3 and **authPriv** mode must be used. The additional Version 3-specific parameters are Security Name, Rights, Authentication Protocol, and Privacy Protocol, for which SHA512 and AES256 should be used as the authentication and privacy protocol algorithms respectively. As always, longer passwords are preferable. You can then launch the SNMP service from the "Network → Network Services" tab.

The screenshot displays the SNMP configuration page with the following sections and fields:

- General Information:**
 - SNMP Contact: software dev
 - SNMP Location: 123456789
 - Activated Protocol Versions: V3 only
- V1 & V2C Parameter:**
 - Read Community: public
 - Write Community: private
- V3 Parameter:**
 - Security Name: root
 - Security Level: authPriv
 - Rights: Readonly Access
 - Clear-Text Engine-ID: ItSNMP_Mec467003002f
 - Authentication Protocol: SHA512
 - Authentication Passphrase: [masked]
 - Re-Enter Passphrase: [masked]
 - Privacy Protocol: AES256
 - Privacy Passphrase: [masked]
 - Re-Enter Passphrase: [masked]

Figure 7.11: SNMP Options

7.3 User Management/Administration

This section describes the administration of user and authentication management. Therefore, it is divided in LANTIME origin and external user authentication. The LANTIME OS supports the two external authentication servers, Radius and TACACS+. You can also see "LTOS Management and Monitoring → Via Web GUI → System → External Authentication" for further information.

7.3.1 LANTIME User Management

The LANTIME delivers a build in user configuration. The options are located under "System → User Management".

There are three different user groups: Super-User, Admin-User and Info-User. Super-Users are allowed to do everything, bash access included. Admin-Users are allowed to do everything that is on the web interface, but no operations that would grant super user rights. Info-Users are just allowed to see all non security relevant informations in the web interface.

The table below illustrates the user-rights of each access level in detail.

| | Super User | Admin User | Info User |
|---|------------|------------|-----------|
| Full access to the Command Line | ✓ | | |
| Change device configuration through the WebUI | ✓ | ✓ | |
| Editing of the additional configuration files, which are available through the WebUI* | ✓ | | |
| Perform a Firmware Update | ✓ | | |
| Create a diagnostic file | ✓ | | |
| Create a new super user account | ✓ | | |
| Review all webinterface configuration values | ✓ | ✓ | ✓ |

*Additional Network Configuration, Additional NTP Configuration, User defined notifications

To create a User, use the form that is shown on Figure 7.12. Super-Users can create all user types. The Admin-User can create other Admin-Users and Info-Users. Enter a name, a password and the group of the user, then press the button **Create User**. If successful, the new user is displayed in the User List, right under the create user form. Choose the user names and passwords in a way that they are not predictable.

Figure 7.12: Create new Super User

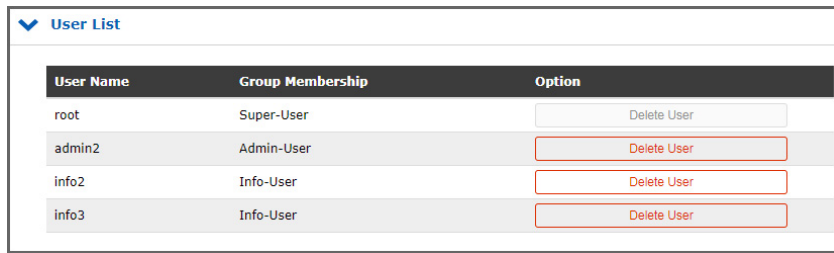

| User Name | Group Membership | Option |
|-----------|------------------|-------------|
| root | Super-User | Delete User |
| admin2 | Admin-User | Delete User |
| info2 | Info-User | Delete User |
| info3 | Info-User | Delete User |

Figure 7.13: User List

For passwords, there are some additional options that are depicted in Figure 7.14. Choose a long password length and a periodical change interval. In addition, you can use the "Allow secure passwords only" checkbox to force a password that contains many different character sets.

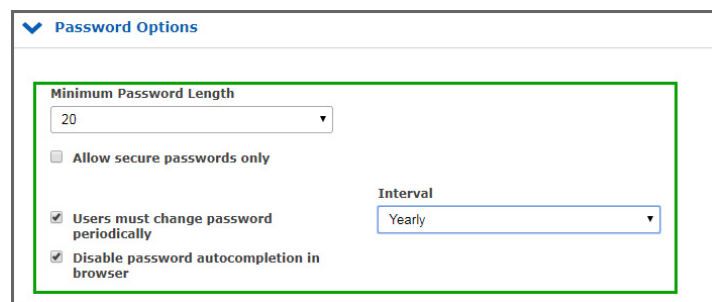

Password Options

Minimum Password Length: 20

Allow secure passwords only

Users must change password periodically

Interval: Yearly

Disable password autocompletion in browser

Figure 7.14: Password Options

7.3.2 External User Authentication: LDAP(S), Radius and TACACS+

This chapter describes the possible external authentication methods provided by the LANTIME firmware.

LDAP (Lightweight Directory Access Protocol)

LDAP is based on the client-server model and is used for so-called directory services. LDAP describes the communication between the LDAP client and the directory server. Object-related data, such as personal data or computer configurations, can be read from such a directory.

RADIUS (Remote Authentication Dial-In User Service)

A RADIUS server is a central authentication server used by services to authenticate clients on a physical or virtual network (VPN). The RADIUS server handles the authentication for the service, i.e. checking the user name and password.

TACACS (Terminal Access Controller Access-Control-System)

TACACS is a communication protocol for authentication, which is standardized and widely used by the IETF. TACACS servers provide a central authentication instance for users. In typical Cisco network environments (e.g. routers and switches), TACACS+ is used for central user management.

7.3.2.1 Order of Authentication Procedures

The order of authentication is as follows once all authentication methods (LDAP, RADIUS, TACACS+ and LOCAL) have been activated and configured

1. LDAP
2. RADIUS
3. TACACS+
4. local authentication

So if the same user names/password phrases are used in different systems, it is possible that the access rights do not work out as desired. In addition, this can quickly lead to intransparent log messages. So you should always pay attention to the order and consistent user data/rights in the services.

7.3.2.2 LDAP and LDAPS

The LANTIME supports the connection to an LDAP server via LDAP and LDAPS. Meinberg recommends setting up secure communication via LDAPS. For this purpose a central trust center (RootCA) must be made known to the LANTIME.

A certificate of a certification authority can be uploaded via the web interface menu "Security → Certificates → CA Certificates". The section [CA Certificates](#) describes the options for uploading root CA certificates. If the LDAP server uses a certificate signed/issued by a global certificate authority, this step is omitted. The list of trusted global certificate authorities is updated with each LANTIME update.

The configuration of an LDAP(S) connection is described in chapter "Web Interface → User Management → External Authentication → [9.1.8.7 \(LDAP Setup\)](#)".

7.3.2.3 External Authentication via LDAP

External authentication via LDAP can be configured in the web interface under "System → User Management → User Administration → External Authentication → LDAP / LDAPS". The LANTIME firmware supports anonymous as well as user related logon. For a Microsoft Active Directory logon, a user name (LDAP user or binddn) and a password phrase (LDAP password or bindpw) must be specified. The search strategy (Search Scope) for AD entries can be changed via base (baseObject), one (singleLevel) and sub (wholeSubtree). The corresponding search path in AD can be specified via the field "Search Base". An example for a path would be "CN=Users,DC=test,DC=mbg,DC=en".

To map the AD information to the local settings, "Filter" and "Mappings" must be created. In AD, the attributes that contain the information needed for a LTOS user can be freely selected. A filter is specified to limit the result set of the LDAP response to the required attributes. The mapping is needed to map attributes of the LDAP directory service that differ from RFC2307 to the correct attributes specified in the RFC that are used by the LDAP service on the LANTIME. For example, the user ID for the passwd mapping is mapped from the freely selected attribute "sAMAccountName" to the attribute "uid" provided for this purpose in RFC2307 by the following mapping: "passwd uid sAMAccountName".

The minimum information to be provided is:

- The User-ID (the login name)
- The User ID number (a number that is not or could not be assigned by a local user)
- The User group number (see below for group membership)
- The user home directory (new folder under /home/)

The only value that cannot be freely assigned in the directory server is the group membership in LTOS. The following values can be stored e.g. in the "gidNumber" attribute:

- The group Super-User has the group ID = 0
- The group Admin-User has the group ID = 4
- The group Info-User has the group ID = 100

The connection to the LDAP server can be specified under the menu item "Global" as soon as a new LDAP server has been added via the button "Add LDAP Server". You can choose between "ldap" and "ldaps" and the URI of the LDAP server must be specified.

Hint

For a LDAPS connection, the URI must match the URI (in the Common Name or the Subject Alternative Names) of the LDAP server certificate, otherwise the verification fails.

The mode controls whether a configured LDAP server is queried. If the port differs from the defaults (389, 636), another can be selected using the "Alternative Port" field. LDAP servers can be removed via the "Misc" tab. If everything is set, the settings must be transferred to the current configuration by clicking the button "Save". After the function test the current configuration can be saved as start configuration.

For the current firmware version 7.02.003, error messages of the ldap service can be viewed via the system messages (CLI or WEB). Authentication errors are written to the `/var/log/auth.log` file.

7.3.2.4 Radius and TACACS Connection

In addition to the users managed by LANTIME itself, a Radius or TACACS connection can be used to authenticate users. This configuration is also located in the User Administration under Add External Authentication Server. Look at Figure 7.15 for the input options. You have to enable External Authentication first. Afterwards, choose radius or TACACS+ from the drop down menu and insert the hostname, the previously exchanged key and the correct port. From now on, you are able to login with the external authentication mechanism. At first the system checks the external server for the user. If no user exists with that credentials, the system checks the local users. It is described in "LTOS Management and Monitoring → Via Web GUI → External Authentication Options" how to configure the external authentication server.

The screenshot shows the 'External Authentication' configuration page. At the top, there are two tabs: 'Radius/TACACS+' (selected) and 'LDAP'. Below this, there is a sub-section for 'Radius/TACACS+' with three sub-tabs: 'Misc', 'Add Server', and 'Server List'. The 'Add Server' tab is active. The form contains the following fields:

- Authentication Method:** A dropdown menu currently set to 'Radius'.
- Authentication Server:** An empty text input field.
- Shared Secret:** An empty text input field with a lock icon on the right.
- Port:** A text input field containing the value '1812'.
- Dropdown Menu:** A dropdown menu on the right side of the form, currently showing 'Radius' as the selected option. Other visible options are '--- Please Select ---' and 'TACACS+'.
- Buttons:** A green button labeled 'Add Authentication Server' is located at the bottom left of the form.

Figure 7.15: Webinterface Menu "System → User Management → External Authentication"

7.4 Securing the NTP Time Service

The NTP time service provides several methods of authenticating and monitoring the integrity of packet transmission. At the time of writing, the NTP autokey method is considered insecure, which is why this guide describes the configuration of the symmetric-key method. Please refer to the chapter "LTOS Management and Monitoring → Via Web GUI → NTP Symmetric Keys" for a detailed description of the configuration options.

As of Version 7.06, the LTOS Firmware also supports the Network Time Security Protocol (NTS) for secure synchronization with external time servers on LANTIME devices with MRS support.

7.4.1 Configuring Symmetric Key Authentication

To configure a connection, the system requires a key. You can either use newly generated keys or add existing keys to the key file using the **Edit NTP Keys** button, which is located under "NTP → NTP Symmetric Keys". If you have keys automatically generated by the system, MD5 and SHA1 keys will be added to the key file. However, for the best security currently available, AES-128-CMAC keys should be used, and these cannot yet be generated automatically.

The process of generating AES-128-CMAC keys is described in the chapter "Configuration → Web Interface → NTP → NTP Symmetric Keys".

Figure 7.16 shows examples of generated and manually modified (AES-128-CMAC) NTP keys. The key IDs must be added to the Trusted Keys under the **General Settings** section of the **NTP** tab (see Figure 7.17). In the **NTP Restrictions** section you can also disable Mode 6 and 7 packet support. It is also possible to enable access controls here so that access is only granted to known IP addresses. The symmetric keys are used for all connection types, i.e. server-to-client connections, connections with external NTP servers, broadcast connections, multicast connections, and manycast connections.

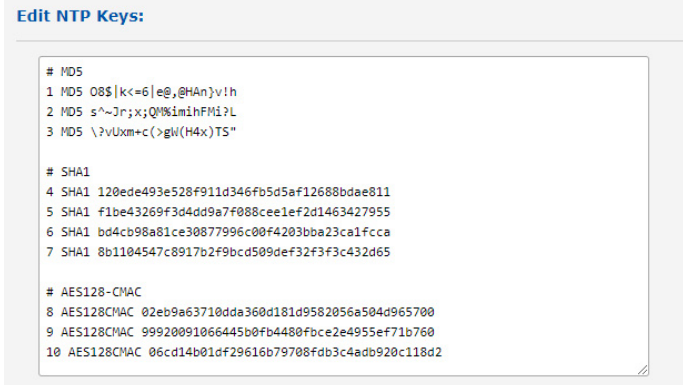

```

Edit NTP Keys:

# MD5
1 MD5 08$|k<=6|e@, @HAN}v!h
2 MD5 s^~Jr;x;Q%imihFMi?L
3 MD5 \?vUxm+c(>gi(H4x)TS"

# SHA1
4 SHA1 120ede493e528f911d346fb5d5af12688bdae811
5 SHA1 f1be43269f3d4dd9a7f088cee1ef2d1463427955
6 SHA1 bd4cb98a81ce30877996c00f4203bba23ca1fccca
7 SHA1 8b1104547c8917b2f9bcd509def32f3f3c432d65

# AES128-CMAC
8 AES128CMAC 02eb9a63710dda360d181d9582056a504d965700
9 AES128CMAC 99920091066445b0fb4480fbce2e4955ef71b760
10 AES128CMAC 06cd14b01df29616b79708fdb3c4adb920c118d2

```

Figure 7.16: Symmetric NTP Keys

General Settings

Stratum Level When Unsynchronized: 12 Disable Stratum Change

NTP Trusttime MRS: 4 Days

Local Trusted Keys: 1 2 3 4 5 6 7 8 9 10

Enable Autokey

Figure 7.17: Trusted Key IDs

The relevant fields for the proper key IDs are marked in Figures 7.18, 7.19, and 7.20. An example configuration file for a client is illustrated in Figure 7.21, showing the path to the key file, the trusted key IDs, and the server IP, which in this case use the key with the ID 1.

External NTP Server

Server Address 1: 172.28.14.2 Use Autokey

Symmetric Key: 1 Use iburst

Minpoll: Auto Maxpoll: Auto

Server Address 2: Use Autokey

Symmetric Key: Use iburst

Minpoll: Auto Maxpoll: Auto

Server Address 7: Use Autokey

Symmetric Key: Use iburst

Minpoll: Auto Maxpoll: Auto

Figure 7.18: External server configuration

▼ Broadcast Settings

Broadcast Address 1: 172.28.14.2

Broadcast Interval: Auto

Symmetric Key: 1

Use Autokey

Broadcast Address 2:

Broadcast Interval: Auto

Symmetric Key:

Use Autokey

Figure 7.19: Broadcast configuration

▼ NTP Multicast & Manycast

Enable Multicast

Multicast Address: 172.28.14.2

Broadcast Interval: Auto

TTL: 127

Symmetric Key: 1

Use Autokey

Enable Manycast

Manycast Address:

Symmetric Key:

Use Autokey

Figure 7.20: Multi and many cast configuration

```

# restrict <IP OF REMOTE HOST>

# Use drift file
driftfile "C:\Program Files (x86)\NTP\etc\ntp.drift"
keys "C:\Program Files (x86)\NTP\etc\ntp.key"
trustedkey 5

# your local system clock, could be used as a backup
# (this is only useful if you need to distribute time no matter how good or bad it is)
#server 127.127.1.0
# but it should operate at a high stratum level to let the clients know and force them to
# use any other timesource they may have.
#fudge 127.127.1.0 stratum 12

# Use specific NTP servers
server x.x.x.1 iburst minpoll 6 maxpoll 7
server x.x.x.2 minpoll 4 maxpoll 4 iburst key 5

# End of generated ntp.conf --- Please edit this to suite your needs

```

Figure 7.21: NTP client configuration

7.4.2 Configuring Network Time Security for External NTP Servers

Note: This option is currently only supported on LANTIME/MRS devices.

The screenshot shows the 'External NTP Server' configuration panel. It contains the following elements:

- Server Address 1:** An empty text input field.
- Symmetric Key:** An empty text input field.
- Use Autokey:** An unchecked checkbox.
- Use iburst:** A checked checkbox.
- Minpoll:** A dropdown menu currently set to 'Auto'.
- Maxpoll:** A dropdown menu currently set to 'Auto'.
- Use NTS:** A checked checkbox, highlighted with a blue border.

Figure 7.22: External NTP Server

To enable NTS-secured time synchronization with external NTP servers, "Use NTS" must be checked in the menu "NTP → External NTP Server" (see Figure 7.22). The **Server Address** must be the IP address or hostname of the corresponding NTS-KE server in this case.

When connecting to a NTS-KE server with a TLS certificate signed by a public certificate authority, it will not usually be necessary to take any further action. It is important to ensure that the system's own root certificates are also verified under "Security → Certificates → CA Certificates".

If the NTS-KE server is a non-public one, the corresponding root certificate must be present on the LAN-TIME device. For more information on the process of uploading custom CA certificates, please refer to the chapter "CA Certificates".

7.5 Event Log Delivery

The LANTIME offers many transport channels for event log information and a fine grained notification selection for each of these channels. Currently, Syslog and SNMPv3 can be secured from the event transport channels. It is a good practice to collect event log informations on a central server to correlate and check them for anomalies. Be aware of potential security related information leakage due to the lack of encryption for services other than **syslog** and **SNMPv3**.

External syslog servers can be configured under "Notifications → External syslog servers". To address them securely the transport protocol "TLS" must be selected. The full configuration options are described in chapter "Web Interface → Notification → External Syslog Server".

The chapter "LTOS Management and Monitoring → Via Web GUI → Notification" describes the configuration options for the transport channels. If you use **SNMPv3** with selected **authPriv** security level, SNMP traps are also sent securely. Configure the SNMP authPriv setting as described in "Security → SNMP" in chapter [Optimizing Management Access Security](#).

7.6 Update and Backup LANTIME Firmware

Download the latest LTOS on <https://www.meinbergglobal.com/english/sw/firmware.htm>. The downloaded LTOS file has to be uploaded via the LANTIME web interface under "System → Firmware/Software Update" like on Figure 7.23. The LTOS V7 firmware is equipped with a digital signature, which is checked during the "Preflight Checks" test directly after upload. If this test detects a faulty signature, a warning is displayed. If this happens, download the new firmware from the Meinberg web site again and repeat the process. In case of repeated warnings please contact the Meinberg support.

In the next step, you have to confirm the update and activate the new firmware like in Figure 7.24. The update was successful if Figure 7.25 is displayed.

Figure 7.23: Upload firmware

```

Perform update?
OK CANCEL  Automatically activate new firmware and reboot device after a successful update.

Running Preflight Checks

Checking base release compatibility ...
INFO: Current version is 7.00.007
OK: Installation file /www/htdocs/upload/update found.
INFO: MD5 Checksum is 0722f3ef2aaa5c630324e7799d20401e /www/htdocs/upload/update
INFO: SHA256 Checksum is 956a1eb817751f026c6fb1165c02f03f59b9953bacb354c55895b17b8ce05718
INFO: Uploaded file size is 38M
Checking required modules...
OK: Required modules in place.
Accessing update file ...
Checking digital signature of file ...
WARNING: Could not verify digital signature of update file: Error: invalid file format/type.
WARNING: This file does not seem to have been digitally signed, please double check that it is a valid update file and t

INFO: Version information in update file: 7.00.8
OK: Installation file is readable.

This firmware image requires a minimum RAM size of 256MB.
Please make sure you are installing it on a suitable device, otherwise it will abort during the
installation process.

INFO: This is a release file, image version is 7.00.8
OK: Update file is suitable for this system [x86].
INFO: Required flash space is 54 MB
INFO: Free flash space is 202 MB

This is a valid install package. Check OK
    
```

Figure 7.24: Update process of the firmware

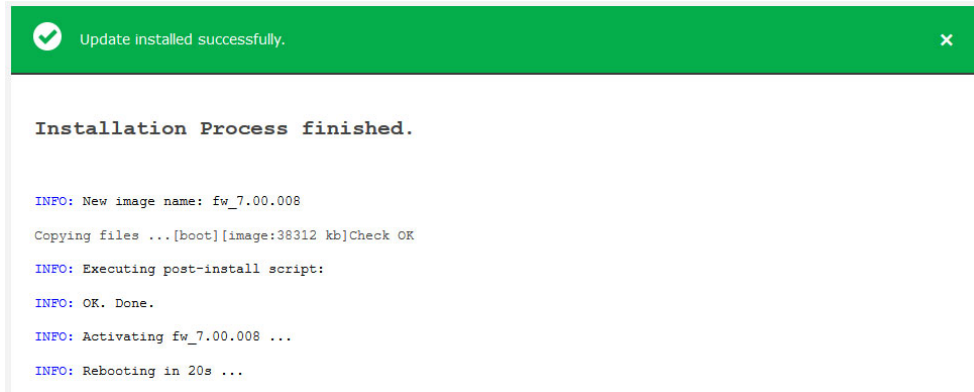

Figure 7.25: Successful firmware update

The configuration settings of the LANTIME will be preserved during a firmware update, except the configuration files of the web server and the SSH service. These files will be overwritten during an update to be able to deliver current cryptographic methods with an update. If, contrary to our recommendation, the automatic update is not desired, a separate customer-specific configuration file can be stored for these services.

SSH configuration:

The configuration file `/etc/ssh/ssh.cfg` defines which configuration file the SSH service should use. In factory configuration the file contains the following entry:

```
[SSHD]
CONFIGFILE=/etc/standard/sshd_config
```

If the file `/etc/standard/sshd_config` is defined as an SSH configuration file, this file is updated during a firmware update. If the file `/etc/ssh/sshd_config` is entered, an own configuration can be created in this file, which is not replaced during an update.

Web server configuration:

The configuration file `/etc/webUI/webUI_custom.cfg` defines which configuration file the web server should use. In the factory configuration the file contains the following entry:

```
[CUSTOM CONFIGURATION]
CUSTOM_CONFIG_PATH=
```

If no file is defined as web server configuration file, the factory configuration file, which is updated during a firmware update, is used. If an arbitrary file is entered under `/mnt/flash/data/`, an own configuration can be created in this file, which is not replaced during an update. Files that are stored under `/mnt/flash/data/` are not part of a configuration, but they are stored reboot-secure (persistent).

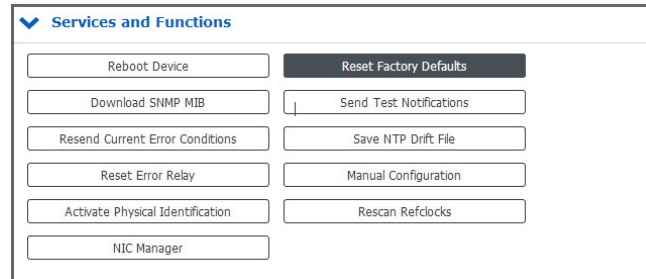

Figure 7.26: Reset factory defaults

To restore automatic configuration updates to the SSH service and the Web server, you can restore the factory paths in these two files.

Restoring the factory defaults via the web interface, as shown in 7.26, resets all custom configuration settings in the current startup configuration except the network settings. In detail, this means that your certificates, credentials, SNMP, NTP and SSH keys, among others, will be lost. Configurations previously saved under a different name are retained even in the event of a factory reset. If desired, these configurations must also be deleted via the web interface.

After the reset via the web interface, all certificates are exchanged to the factory defaults. The SSH key is randomly regenerated at startup after reset.

A backup of the LANTIME firmware, if downloaded or saved on flash of the LANTIME, is in clear text form. For this reason make sure, that no unauthorized person has access to it. The same takes effect for a diagnostic file.

8 Antenna and Receiver Information

There are 2 types of radio signals commonly used for timing applications: **satellite signals from Global Navigation Satellite Systems (GNSS)**, and **long wave signals** from specific time code transmitters operated by some countries.

Most GNSS signals can be received world-wide, while long wave signals can only be received up to a certain distance around the transmitting station. Also, GNSS receivers can usually track the signals from several satellites at the same time, so the signal propagation delay can be determined and compensated automatically, while long wave receivers usually receive only the signal from a single station. Last but not least the available bandwidths and signal propagation characteristics are another reason why GNSS reception usually yields a higher degree of time accuracy than long wave reception.

8.1 Reference Time Sources

8.1.1 Meinberg GPS Receiver

The satellite radio clock was developed with the aim of providing users with a highly accurate time and frequency reference. High accuracy and the possibility of worldwide use, 24 hours a day, are the main features of this system, which receives its time information from the satellites of the Global Positioning System. The Global Positioning System (GPS) is a satellite-based system for radio-positioning, navigation, and time-transfer.

This system has been installed by the United States Department of Defense (Defense Department) and provides two levels of accuracy: the Standard Positioning Services (SPS) and the Precise Positioning Services (PPS).

The structure of the sent data of the PLC has been released and the reception has been made available for general use, while the time and navigation data of the even more accurate PPS are transmitted encrypted and therefore only accessible to certain users (mostly military). The principle of location and time determination with the aid of a GPS receiver is based on the most possible accurate measurement of the signal propagation time from the individual satellites to the receiver.

The GPS satellites orbit the earth on six orbital tracks in 20,000 km of altitude once in about 12 hours. This ensures that at any time at least four satellites are in sight at any point on the earth. Four satellites must be received at the same time so that the receiver can determine its spatial position (x, y, z) and the deviation of its clock from the GPS system time.

Control stations on earth measure the orbits of the satellites and record the deviations of the atomic clocks carried on board from the GPS system time. The determined data are sent to the satellites and sent to earth as navigation data by the satellites. The highly precise track data of the satellites, called ephemerides, are needed so that the receiver can calculate the exact position of the satellites in space at any time. A set of track data with reduced accuracy is called almanac. With the aid of the almanacs, the receiver calculates at approximately known position and time, which of the satellites are visible from its location. Each of the satellites transmits its own ephemerides as well as the almanacs of all existing satellites. The GPS clock operates with the "Standard Positioning Service". The data stream of the satellites are decoded and evaluated by the microprocessor of the system, like that the GPS system time is reproduced with a deviation of less than 100 nsec. Different running times of the signals from the satellites to the receiver are automatically compensated by determining the receiver position. By tracking the main oscillator, a frequency accuracy of $1e-12$ is achieved, depending on the oscillator type. At the same time, the age-related drift is compensated. The current correction value of the oscillator is stored in a non-volatile memory of the system.

8.1.2 Meinberg GNSS Receiver (GPS, GLONASS, Galileo, BeiDou)

High accuracy and the possibility of the world wide operation around the clock are the main features of the system, which receive his time information from the satellites of the American GPS (Global Positioning System), the European Galileo, the Russian GLONASS (Global Navigation Satellite System) and the Chinese BeiDou.

The Global Positioning System (GPS) is a GNSS operated by the US department of defense. Its purpose is to provide position, velocity and time for civilian and defense users on a global basis. The system currently consists of 32 medium earth orbit satellites and several ground control stations.

GLONASS is a GNSS operated by Russian Federation department of defense. Its purpose is to provide position, velocity and time for civilian and defense users on a global basis. The system consists of 24 medium earth orbit satellites and ground control stations. The GLONASS satellites circle the earth once on three orbital lanes in height of 19100km in about 12 hours.

Galileo is a GNSS operated by the European Union. Its purpose is to provide position, velocity and time for civilian users on a global basis. The system is currently not fully operational. It is eventually expected to consist of 30 medium earth orbit satellites. At the time of writing (early 2016), the Galileo system was still under development with only a few fully operational SVs. Therefore, the precise performance and reliability of u-blox receivers when receiving Galileo signals is effectively impossible to guarantee.

BeiDou is a GNSS operated by China. Its purpose is to initially provide position, velocity and time for users in Asia. In a later stage when the system is fully deployed it will have worldwide coverage. The full system will consist of five geostationary, five inclined geosynchronous and 27 medium earth orbit satellites, as well as control, upload and monitoring stations.

Characteristics

The GNS module is a combined GPS / Galileo / GLONASS / BeiDou receiver and operates with the "Standard Positioning Service" (GPS) or "Standard Precision" (Galileo, GLONASS, BeiDou). The data stream from the satellites is decoded by the microprocessor of the system. By analyzing the data, the GNSS system time can be reproduced very precisely. Different running times of the signals from the satellites to the receiver are automatically compensated by determining the receiver position. By tracking the main oscillator (Oven Controlled Xtal Oscillator, OCXO) a high frequency accuracy is achieved. At the same time, the aging-induced drift of the quartz is compensated. The current correction value for the oscillator is stored in a non-volatile memory of the system. This receiver is suitable not only for stationary operation but also for mobile use.

The Meinberg GLN receiver is the predecessor of the GNS clock and receives GPS, Glonass and BeiDou.

8.1.3 PZF - DCF77 Long Wave Receiver

The German long wave transmitter DCF77 started continuous operation in 1970. The introduction of time codes in 1973 build the basic for developing modern radio remote clocks. The DCF77 frequency and signal is derived from the atomic clocks of the Physikalisch-Technische Bundesanstalt (PTB) in Braunschweig, Germany, the national institute for science and technology and the highest technical authority of the Federal Republic of Germany for the field of metrology and physical safety engineering.

The carrier frequency of 77.5 kHz is amplitude modulated with time marks each second. The BCD-coding of the time telegram is done by shifting the amplitude to 25% for a period of 0.1s for a logical '0' and for 0.2s for a logical '1'. The receiver reconstructs the time frame by demodulating this DCF-signal. Because the AM signal is normally superimposed by interfering signals, filtering of the received signal is required. The resulting bandwidth-limiting causes a skew of the demodulated time marks which is in the range of 10 ms. Variations of the trigger level of the demodulator make the accuracy of the time marks worse by additional +/-3 ms. Because this precision is not sufficient for lots of applications, the PTB (Physical and Technical Institute of Germany) began to spread time information by using the correlation technique.

The DCF-transmitter is modulated with a pseudo-random phase noise in addition to the AM. The pseudo-random sequence (PZF) contains 512 bits which are transmitted by phase modulation between the AM-time marks. The bit sequence is built of the same number of logical '0' and logical '1' to get a symmetrical PZF to keep the average phase of the carrier constant. The length of one bit is 120 DCF-clocks, corresponding to 1.55 ms. The carrier of 77.5 kHz is modulated with a phase deviation of +/-10 per bit. The bit sequence is transmitted each second, it starts 200ms after the beginning of an AM second mark and ends shortly before the next one. Compared to an AM DCF77-receiver, the input filter of a correlation receiver can be dimensioned wideband width. The incoming signal is correlated with a reconstructed receiver-PZF. This correlation analysis allows the generation of time marks which have a skew of only some microseconds. In addition, the interference immunity is increased by this method because interference signals are suppressed by averaging the incoming signal. By sending the original or the complemented bit sequence, the BCD-coded time information is transmitted.

The absolute accuracy of the generated time frame depends on the quality of the receiver and the distance to the transmitter, but also on the conditions of transmission. Therefore, the absolute precision of the time frame is better in summer and at day than in winter and at night. The reason for this phenomenon is a difference in the portion of the sky wave which superimposes the ground wave. To check the accuracy of the time frame, the comparison of two systems with compensated propagation delay is meaningful.

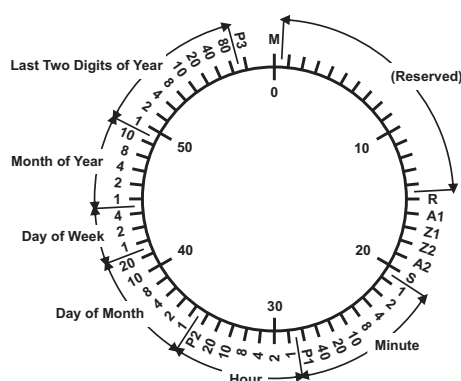

| | |
|------------|--|
| M | Start of Minute (0.1 s) |
| R | RF Transmission via Secondary Antenna |
| A1 | Announcement of a Change in Daylight Saving Time |
| Z1, Z2 | Time Zone Identification |
| | Z1, Z2 = 0, 1: Daylight Saving Time Disabled |
| | Z1, Z2 = 1, 0: Daylight Saving Time Enabled |
| A2 | Announcement of a Leap Second |
| S | Start of Time Code Information |
| P1, P2, P3 | Even Parity Bits |

The PZF radio clock is a precision receiver system for the time signal transmitter DCF77. It is available as a module for use in systems such as Meinberg IMS, LANTIME M300 models and as a computer plug-in card. The microprocessor of the system performs the correlation of a reproduced pseudo-random bit sequence with the PZF of the transmitter side and simultaneously decodes the AM time and date information of the DCF telegram. By evaluating the pseudo-random phase noise, a time raster can be generated which is up to a factor of a thousand more accurate than the ones of conventional AM radio clocks. In this way, an exact adjustment of the main oscillator of the radio-controlled clock is also possible, this allows it to be also used as a normal frequency generator, in addition to being used as a pure time receiver. If the PZF signal is temporarily unavailable for some reason, i.e. because a source of interference is in the vicinity, the radio clock will automatically switch to the AM signal – provided this is still receivable. The correlation receiver has a battery-buffered hardware clock, which takes over the time and date in the event of failure of the supply voltage.

8.1.4 MSF Receiver

The transmission of the MSF signal from Anthorn serves to distribute the British standard of the time and frequency signals. These standards are set by the National Physical Laboratory (NPL). The MSF signal provides sufficient field strength for use in the UK and can also be received in large parts of North and Western Europe. A simple on-off modulation of the carrier frequency (60kHz) is used to transmit BCD encoded time and date information. Each UTC second is marked with "off", preceded by at least 500 ms of carrier. This second marker is transmitted with an accuracy of ± 1 ms. The time code format is displayed via a minute frame, which is used to transfer the data to the next minute. The bits "A" and "B" are used to send the information (see graphic code format below).

The first second of the minute begins with a period of 500 ms with the carrier "off", to serve as a minute marker. The other 59 (or, exceptionally, 60 or 58) seconds of the minute always begin with at least 100 ms "off" and end with at least 700 ms of carrier "on". Seconds 01-16 carry information for the current minute about the difference (DUT1) between astronomical time and atomic time, and the remaining seconds convey the time and date code. The time and date code information is always given in terms of UK clock time and date, which is UTC in winter and UTC+1h when Summer Time is in effect, and it relates to the minute following that in which it is transmitted.

The MSF radio clock is a radio clock receiver system for the time signal transmitter MSF. It is available as a module for use in systems such as Meinberg IMS and LANTIME M300 models. The microprocessor of the system decodes the time and date information of the incoming AM signal. In this way, an exact adjustment of the main oscillator of the radio-controlled clock is also possible. The MSF receiver is equipped with a battery-buffered hardware clock, which takes over the time and date in the event of failure of the supply voltage.

Code Format

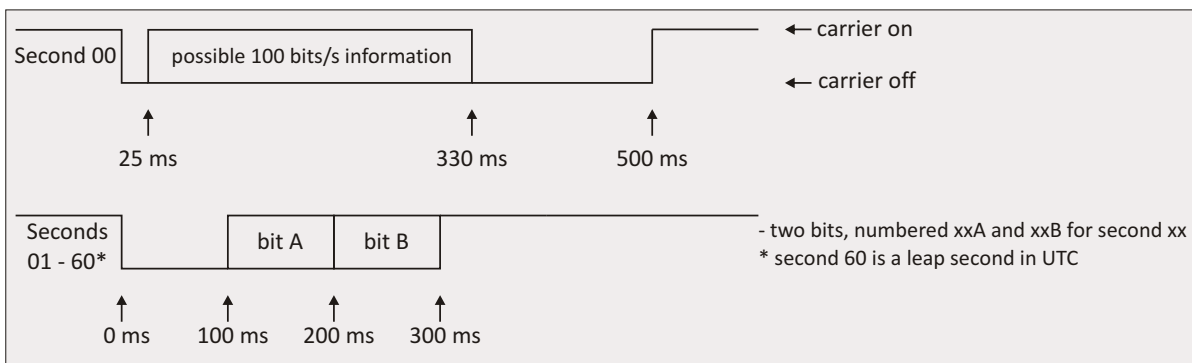

DUT Code

The DUT1 is signaled to the nearest 100ms in the range of ± 800 ms. A positive figure means that GMT is at a higher count than UTC. Bits 01B to 16B are used to signal the DUT code in the following way.

Time and Date Code

Time and date information is transmitted and coded in the following way:

| Binary-Coded-Decimal Year (00-99) | | | | | | | | | | | | | | |
|-----------------------------------|-----|-----|-----|-----|--------------------------|-----|-----|-----|-----|-----|-----------------------|-----|-----|-----|
| order | 80 | 40 | 20 | 10 | 8 | 4 | 2 | 1 | | | | | | |
| bit | 17A | 18A | 19A | 20A | 21A | 22A | 23A | 24A | | | | | | |
| BCD month (01-12) | | | | | BCD day-of-month (01-31) | | | | | | BCD day-of-week (0-6) | | | |
| order | 10 | 8 | 4 | 2 | 1 | 20 | 10 | 8 | 4 | 2 | 1 | 4 | 2 | 1 |
| bit | 25A | 26A | 27A | 28A | 29A | 30A | 31A | 32A | 33A | 34A | 35A | 36A | 37A | 38A |
| BCD hour (00-23) | | | | | BCD minute (00-59) | | | | | | | | | |
| order | 20 | 10 | 8 | 4 | 2 | 1 | 40 | 20 | 10 | 8 | 4 | 2 | 1 | |
| Bit | 39A | 40A | 41A | 42A | 43A | 44A | 45A | 46A | 47A | 48A | 49A | 50A | 51A | |

Other Codes

Minute Identifier

Bits 53A to 58A are all set permanently at '1' and are always preceded by bit 52A at '0' and followed by bit 59A at '0'. This sequence '01111110' never appears elsewhere in bit xxA, so it uniquely identifies the following second 00 minute marker. In minutes lengthened or shortened by a positive or negative leap second all these numbers are correspondingly increased or decreased by one (i.e. during these 61- or 59-second minutes the position of the time and date code is shifted by one second relative to the start of minute).

Parity Bits

The parity bits are providing an odd number of 1's.

Bit 54B taken with bits 17A to 24A

Bit 55B taken with bits 25A to 35A

Bit 56B taken with bits 36A to 38A

Bit 57B taken with bits 39A to 51A

Summer Time

When UK civil time is subject to a one-hour positive offset during part of the year, this period is indicated by setting bit 58B to '1'. Bit 53B is set to '1' during the 61 consecutive minutes immediately before a change, the last being minute 59, when bit 58B changes.

Unused Bits

The unused bits are currently set to '0', but may be used in the future.

8.1.5 WWVB Receiver

NIST radio station WWVB is located near Fort Collins, Colorado, on the same site as station WWV. The WWVB broadcast is used by millions of people throughout North America to synchronize consumer electronic timing products such as wall clocks, clock radios, and wristwatches. In addition, WWVB is used for high level applications including network time synchronization and frequency calibration. The WWVB transmission is maintained by the National Institute of Standards and Technology (NIST).

WWVB continuously broadcasts a time and frequency signal at 60 kHz. The carrier frequency provides a stable frequency reference traceable to the national standard. There are no voice announcements on the station, but a time code is synchronized with the 60 kHz carrier and broadcast continuously at the rate of 1 bit per second using pulse width modulation. The carrier power level is modulated to encode the time data. The carrier power is reduced by 17 dB at the start of each second, so that the leading edge of every negative going pulse is on time. Full power is restored 0.2 s later for a binary #0#, 0.5 s later for a binary #1#, or 0.8 s later to convey a position marker. The binary coded decimal (BCD) format is used, which combines binary digits to represent decimal numbers. The time code contains the year, day of year, hour, minute, second, and flags that indicate the status of Daylight Savings Time, leap year, and leap seconds. WWVB identifies itself by advancing its carrier phase 45 degrees at 10 minutes after the hour and returning to normal phase at 15 minutes after the hour. If you plot WWVB phase, this results in a phase step of approximately 2.08 microseconds.

8.1.6 TCR Receiver

The Board Meinberg TCR (Time Code Receiver) was designed for the decoding of unmodulated and modulated IRIG- and AFNOR-Timecodes. Modulated codes transport the time information by modulating a sinusoidal carrier signals amplitude whereas unmodulated signals employ a pulse width modulated DC signal.

The receivers automatic gain control allows the reception of signals within a range from abt. 600mVpp up to 8Vpp. The potential free input can be jumper selectable terminated in either 50 Ohm, 600 Ohm or 5 kOhm. Modulated codes are applied to the board via an on board SMB connector.

Abstract of Time Code

The transmission of coded timing signals began to take on widespread importance in the early 1950's. Especially the US missile and space programs were the forces behind the development of these time codes, which were used for the correlation of data. The definition of time code formats was completely arbitrary and left to the individual ideas of each design engineer. Hundreds of different time codes were formed, some of which were standardized by the "Inter Range Instrumentation Group" (IRIG) in the early 60's.

Except these "IRIG Time Codes", other formats like NASA36, XR3 or 2137 are still in use. The TCR receiver generates the IRIG-B, AFNOR NFS 87-500 code as well as IEEE1344 code which is an IRIG code, extended by information for time zone, leap second and date.

8.2 GNSS Signal Reception

The satellites of most **Global Navigation Satellite Systems (GNSS)** like **GPS**, **GLONASS**, and **Galileo** are not stationary but circle round the globe in periods of several hours. Only few GNSS systems like the Chinese **Beidou** system work with stationary satellites. Such systems can only be received in certain regions of the Earth.

GNSS receivers need to track at least four satellites to determine their own position in space (x, y, z) as well as their time offset from the GNSS system time (t). Only if the receiver can determine its own position accurately the propagation delay of the satellite signals can also be compensated accurately, which is requirement to yield an accurate time. If the receiver position can only be determined less accurately then the accuracy of the derived time is also degraded.

GNSS satellite signals can only be received directly if no building is in the line-of-sight from the antenna to the satellite. The signals can eventually be reflected at buildings, etc., and the reflected signals can then be received. However, in this case the true signal propagation path is longer than expected, which causes a small error in the computed position, which in turn yields less accurate time.

Since most of the satellites are not stationary, the antenna has to be installed in a location with as much clear view of the sky as possible (e.g. on a rooftop) to allow for continuous, reliable reception and operation. Best reception is achieved when the antenna has a free view of 8° angular elevation above the horizon. If this is not possible then the antenna should be installed with the best free view to the sky in direction of the equator. Since the satellite orbits are located between latitudes 55° North and 55° South, this allows for the best possible reception.

Meinberg provides their own GPS receivers which operate with an antenna/converter unit and thus allow for very long antenna cables, but some devices also include GNSS receivers which support other satellite systems like GLONASS, or Galileo in addition to GPS. These receivers usually require a different type of antenna equipment which is described in chapter (4.1.2).

8.2.1 Meinberg GPS Antenna/Converter

8.2.1.1 Introduction

The Meinberg **GPS antenna/converter unit** combines a standard GPS patch antenna with a frequency converter which translates the original 1.5 GHz signal received from the GPS satellites to an intermediate frequency, so a standard coaxial cable type like RG58 can be used for antenna cable lengths up to 300 meters (1000 ft). If a low-loss cable type like RG213 is used then even 700 meters (2300 ft) between receiver and antenna are possible without requirement for an additional amplifier.

Surge protectors are optionally available and should be used in the antenna line to protect the receiver from high voltages spikes e.g. due to lightning strikes close to the antenna. The antenna/converter unit is remotely powered by the connected GPS receiver via the antenna cable, so no external power supply is required near the location of the antenna if a coaxial cable is used.

If more than a single GPS receiver are to be operated then a **GPS antenna splitter** can be used to distribute the GPS signal from a single antenna. The GPS antenna splitter provides 4 outputs and can be cascaded to supply even more than 4 receivers with the GPS signal.

Alternatively there is also a **GPS Optical Antenna Link (GOAL)** available which uses a fiber optic connection between the antenna and the receiver which allows for a length up to 2000 meters (6500 ft), and provides a high level of insulation and surge protection due to the optical transmission. Since the fiber optic connection is unable to provide the antenna with DC current, an extra power supply is required in this case at the location of the antenna.

Due to the specific requirements for remote powering and frequency conversion the Meinberg GPS equipment is not necessarily compatible with GPS equipment from 3rd party manufacturers.

8.2.1.2 Mounting and Installation of the GPS Antenna

Proper installation of the GPS antenna/converter unit is illustrated in the figure below:

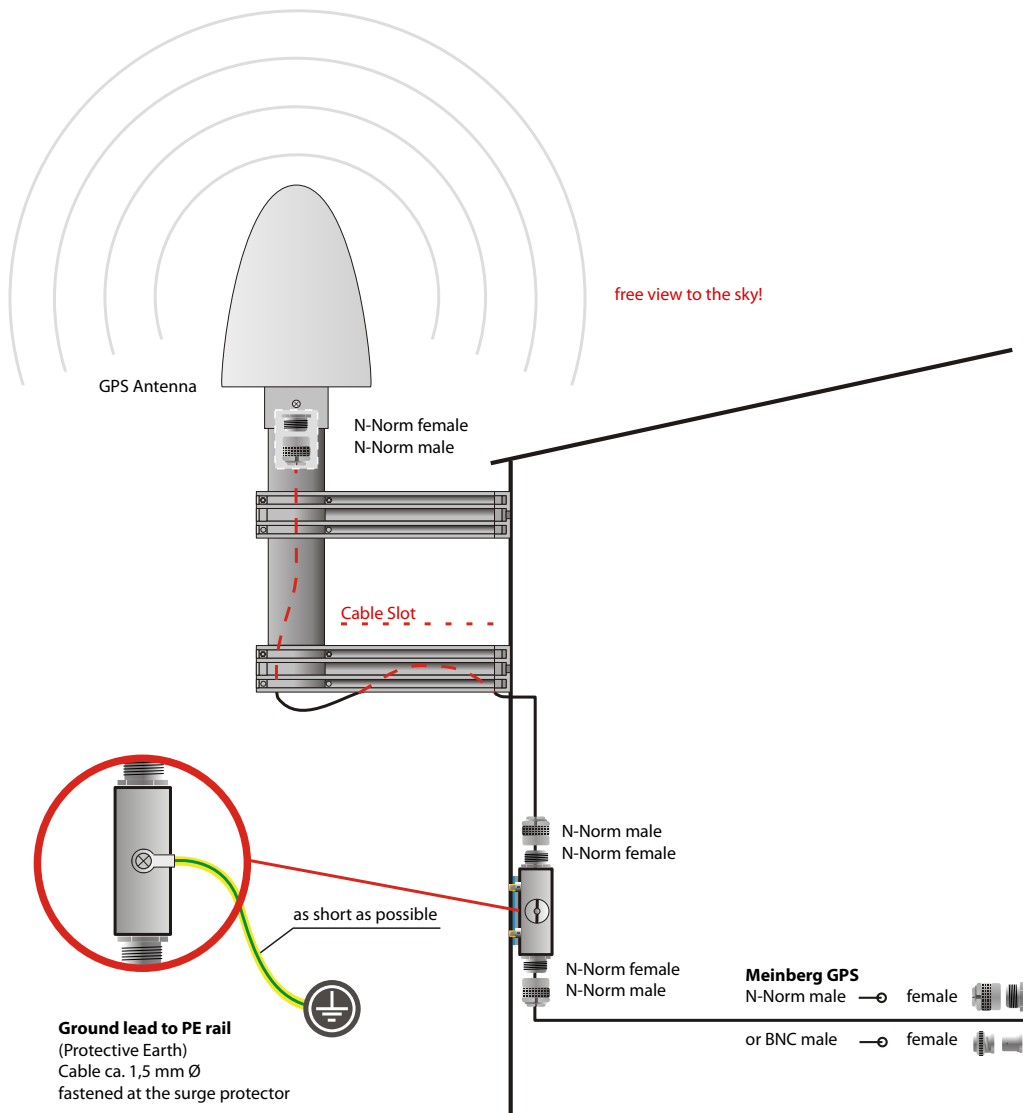

Figure: GPS Antenna mounted on a pole with a free view of the sky. The optional surge protector keeps high voltage strikes through the antenna cable away from the receiver.

Mounting material (plastic pole and holders, clamps for wall or pole mounting) is shipped with all Meinberg GPS antennae for easy installation. A standard RG58 antenna cable of 20 meters length is included by default. If a different cable length is required then this can be ordered accordingly.

Surge protectors should be installed indoors, directly where the antenna cable comes in. The optionally delivered protection kit is not for outdoor usage. The ground lead should be kept as short as possible and has to be connected to building's ground rod.

Up to four GPS receivers can be fed by a single antenna/down-converter unit by using an antenna splitter which can optionally be cascaded. The total length of an antenna cable from the antenna to each receiver must not exceed the specified maximum length according to the cable type. The position of the splitter in the antenna line does not matter.

Note:

If the antenna cable is assembled locally instead of using a cable shipped with the GPS receiver it has to be made sure that the connectors have been soldered and assembled properly, and that there is no short-circuit in the cable or in one of the connectors. Otherwise GPS reception may be degraded, or the GPS receiver can even be damaged. Mount the antenna at a distance of at least 50 cm from other antennas.

**WARNING!**

Do not mount the antenna without an effective fall arrester!

Danger of death from falling!

- Ensure that you work safely when installing antennas!
- Never work without an effective fall arrester!

**WARNING!**

Do not work on the antenna system during thunderstorms!

Danger of death from electric shock!

- Do not carry out any work on the antenna system or the antenna cable if there is a risk of lightning strike.
- Do not carry out any work on the antenna system if it is not possible to maintain the prescribed safe distance to exposed lines and electrical substations.



8.2.2 General GNSS Antennae

Some Meinberg devices use alternate GNSS receivers which support other satellite systems like GLONASS, Galileo or BeiDou, in addition to GPS. These receivers can't be operated directly with the standard Meinberg antenna/converter unit described in chapter "Meinberg GPS Receiver", so they require a different kind of antenna.

There are two different antenna versions available, one of which is more suited for stationary installation, while the other one should be preferred for mobile applications.

8.2.2.1 GNSS Antenna for Fixed-Location Installation

The **Multi-GNSS Antenna** is an active GNSS L1 antenna capable of receiving signals from the GPS, GLONASS, Galileo and BeiDou satellite systems. It is very well-suited to fixed-location installations. It is powered by a 5 V DC power supply from the receiver and offers integrated surge protection.

The antenna cable can be up to 70 meters in length if using a suitable low-loss coaxial cable such as Belden H155.

Installation of the GNSS/L1 Antenna

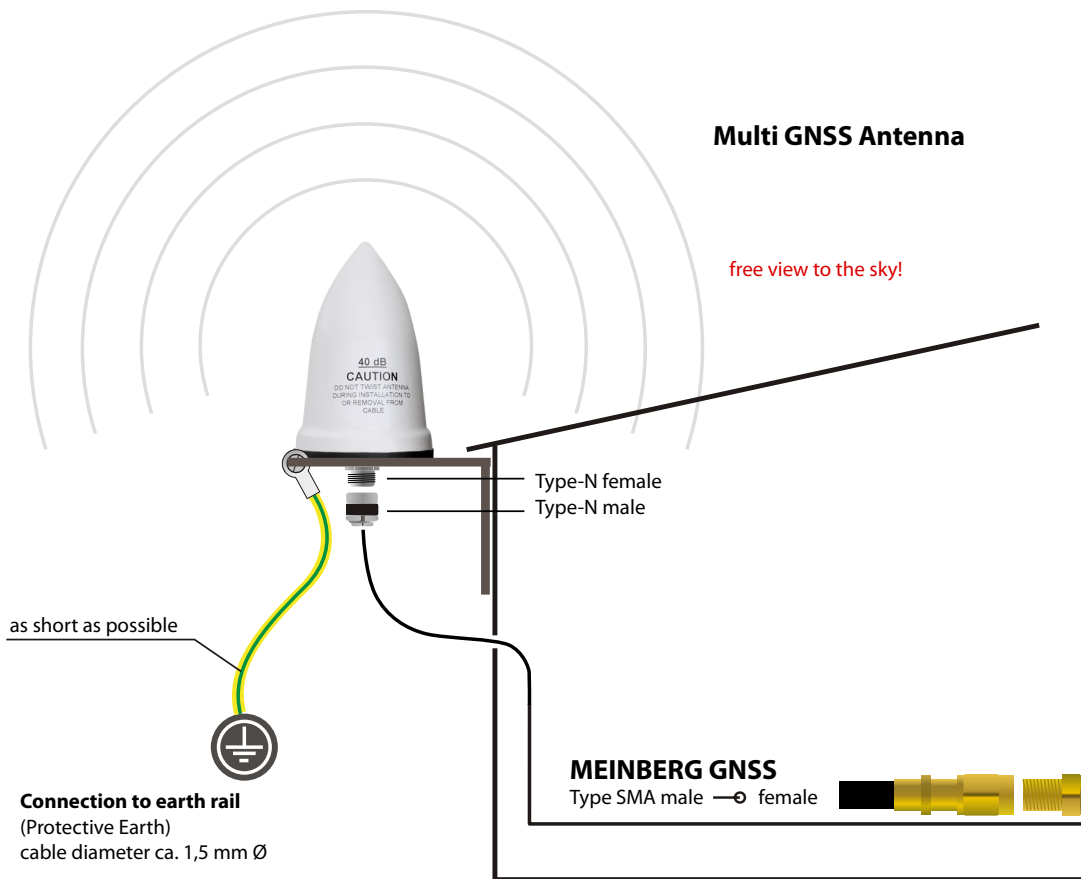

Image: Diagram Showing the Installation of the Multi-GNSS Antenna



WARNING!

Do not mount the antenna without an effective fall arrester!

Danger of death from falling!

- Ensure that you work safely when installing antennas!
- Never work without an effective fall arrester!



WARNING!

Do not work on the antenna system during thunderstorms!

Danger of death from electric shock!

- Do not carry out any work on the antenna system or the antenna cable if there is a risk of lightning strike.
- Do not carry out any work on the antenna system if it is not possible to maintain the prescribed safe distance to exposed lines and electrical substations.



8.2.2.2 GNSS Antenna for Mobile Applications

The RV-76G is an active GNSS antenna which can receive the signals of the GPS, GLONASS, and Galileo satellite systems. It operates with a 5V DC supply voltage provided by the receiver, and should be preferred for mobile applications. However, the maximum length of the antenna cable is limited depending on the cable type, e.g. 5 meters with RG174/U cable, so this antenna is less suitable for stationary installations.

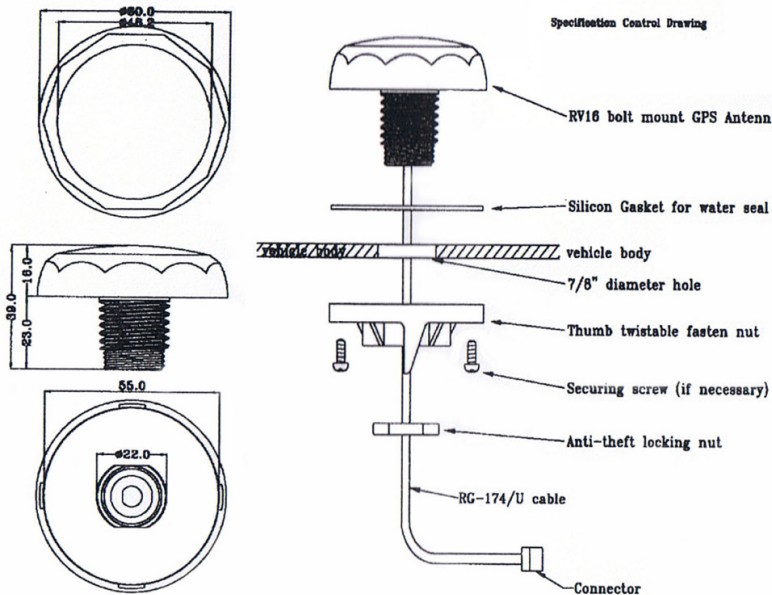



Figure: Installation drawing RV-76G antenna



WARNING!
Do not mount the antenna without an effective fall arrester!

Danger of death from falling!

- Ensure that you work safely when installing antennas!
- Never work without an effective fall arrester!



WARNING!
Do not work on the antenna system during thunderstorms!



Danger of death from electric shock!

- Do not carry out any work on the antenna system or the antenna cable if there is a risk of lightning strike.
- Do not carry out any work on the antenna system if it is not possible to maintain the prescribed safe distance to exposed lines and electrical substations.

8.2.3 Powering up a GNSS Receiver

If both the antenna and the power supply have been connected the system is ready to operate. Depending on the type of oscillator installed in the receiver it takes about 10 seconds (OCXO-LQ) until 3 minutes (OCXO-MQ / HQ) until the oscillator has warmed up and reached the required frequency accuracy.

If the receiver has some valid almanac data in its battery buffered memory and the receiver's position has not changed significantly since its last operation the receiver can determine which satellites are in view. Only a single satellite needs to be received to synchronize and generate output pulses, so synchronization can be achieved at least one minute (OCXO-LQ) until 10 minutes (OCXO-MQ / HQ) after power-up. After 20 minutes of operation the OCXO is fully adjusted and the generated frequencies are within the specified tolerances.

If the receiver position has changed by some hundred kilometers since last operation, the expected satellites may not be in view after power-up. In this case the receiver switches to **Warm Boot** mode where it starts scanning for all possible satellites one after the other. Once the receiver can track at least 4 satellites at the same time it updates its own position and switches to **Normal Operation**.

If no valid data can be found in the battery buffered memory, e.g. because the battery has been disconnected or replaced, the receiver has to scan for satellites and collect the current almanac and ephemeris data first. This mode is called **Cold Boot**, and it takes at least 12 minutes until all required data have been collected. The reason is that the satellites send all data repeatedly once every 12 minutes. After data collection is complete the receiver switches to **Warm Boot** mode to scan for more satellites, and finally enters **Normal Operation**.

In the default configuration neither pulse and synthesizer outputs, nor the serial ports are enabled after power-up until synchronization has been achieved. However, it is possible to configure some or all of those outputs to be enabled immediately after power-up.

If the system starts up in a new environment (e. g. receiver position has changed or new power supply has been installed) it can take some minutes until the oscillator's output frequency has been adjusted properly. In this case the accuracy of the output frequency and pulses is also reduced until the receiver's control loops have settled again.

On the frontpanel ("Reference Time → Info GPS → GPS Satellites") as well as via the Web GUI ("Clock → Receiver Information") you can check the number of satellites that are in view (i.e. above the horizon) and considered good (i.e. are healthy and can be tracked).

8.3 Long Wave Signal Reception

8.3.1 Introduction

The longwave antenna **AW02** is a weatherproof and temperature resistant active antenna for outdoor use. It includes a ferrite antenna for reception of the longwave signal, and an amplifier, both assembled in a plastic housing. The standard version has been designed to receive the signal from the German longwave transmitter **DCF77** whose carrier frequency is 77.5 kHz. The DCF77 transmitter is operated by the German Physikalisch-Technische Bundesanstalt (PTB), and is located in Mainflingen near Frankfurt / Main. Its signal can be received in Germany and adjacent countries.

The variant **AW02-MSF** is available for the longwave transmitter **MSF** which is located in Anthorn / U.K., and transmits the time and frequency maintained by the U.K. National Physical Laboratory (NPL). The signal can be received throughout the U.K., and in wide parts of Northern and Western Europe.

Another variant is the **AW02-WWVB** which has been adapted for the **WWVB** radio station which is located in the United States near Fort Collins, Colorado, and is maintained by U.S. National Institute of Standards and Technology (NIST).

Even though these antenna variants are slightly different according to the characteristics of the associated transmitter, the basic requirements for installation are identical.

The longwave antennae can be operated with a cable length up to 300 meters (1000 ft) if standard RG58 coaxial cable is used. They are remotely powered by the receiver via the antenna cable, so no external power supply is required near the location of the antenna if a direct coaxial cable is used.

Surge protectors are optionally available and should be used in the antenna line to protect the receiver from high voltages spikes e.g. due to lightning strikes close to the antenna.

For longer distances from the antenna to the receiver an optional amplifier can be used, which requires an extra power supply. The **BLV** device is an amplifier with integrated surge protector.

Alternatively there is a **DCF Optical Antenna Link (DOAL)** available which uses a fiber optic connection between the antenna and the receiver which allows for a length up to 2000 meters (6500 ft), providing a high level of insulation and surge protection due to the optical transmission. Again, the default device has been designed for DCF77, but there are also variants for MSF and WWVB available. Since the fiber optic connection is unable to provide the antenna with DC current, an extra power supply is required in this case at the location of the antenna.

Longwave receiver equipment from Meinberg has specifically been designed for Meinberg devices and is not necessarily compatible with receivers from 3rd party manufacturers.

8.3.2 Mounting and Installation of a Longwave Antenna

The careful selection of the antenna location should be at the beginning of each antenna installation. It determines the reception quality and therefore the availability of the DCF77 reception signal decisively. In principle, a DCF77 reception within buildings is possible, however, the DCF77 reception may deteriorate due to metallic objects (e.g. reinforced concrete walls, metal facades, heat protection glazing etc.) that shield or attenuate the reception.

For this reason we always recommend to mount the antenna outside of buildings. This has the advantage that the signal interference distance to electronic devices in buildings is usually enhanced and the reliability of the synchronisation is thus significantly increased.

Proper installation of an antenna for DCF77, MSF, or WWVB is illustrated in the figure below:

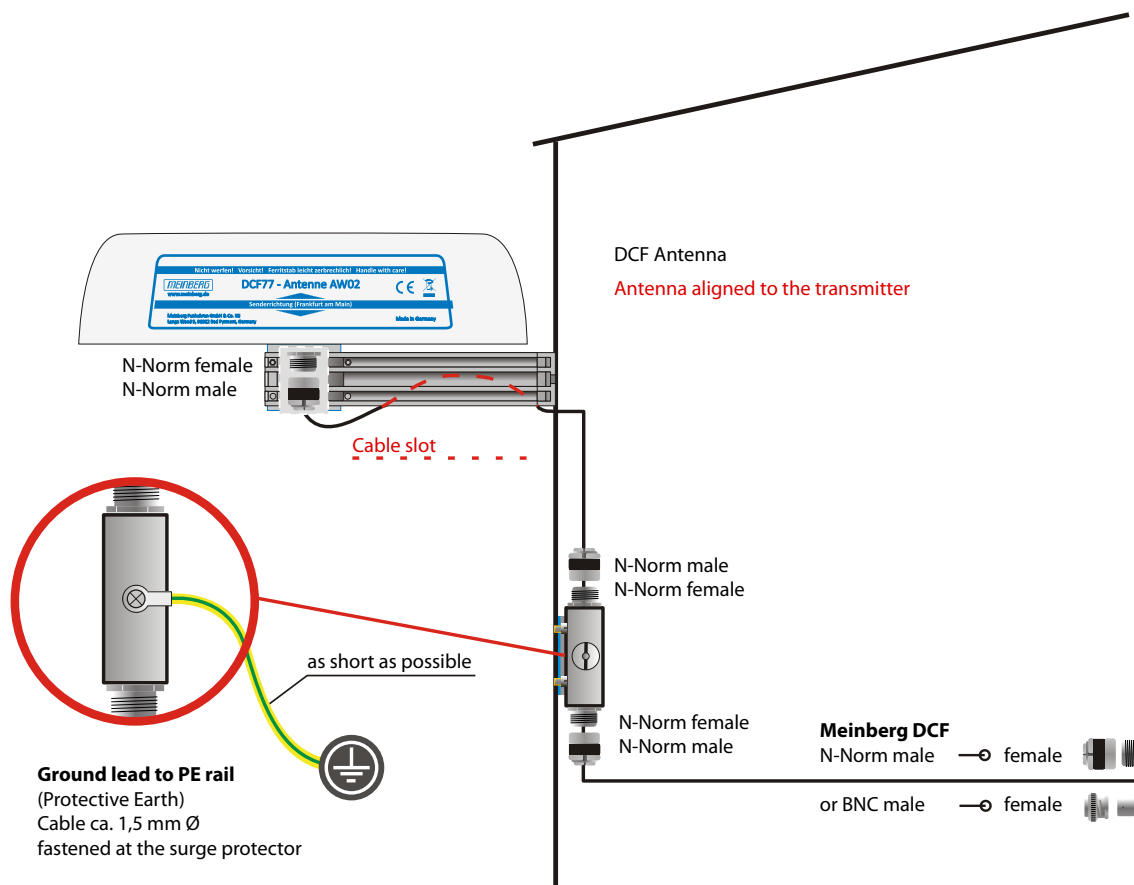

Figure: Longwave antenna mounted on a wall. The optional surge protector keeps high voltage strikes through the antenna cable away from the receiver.

The antenna has to be aligned horizontally in longitudinal direction to the transmitter, i.e. in direction to Mainflingen near Frankfurt / Main in case of DCF77, or in direction to the location of the MSF or WWVB receiver accordingly.

If the antenna is not aligned properly then signal reception is degraded, which can result in a limited time accuracy. The antenna should be installed with a minimum distance of 30 cm away from all metal objects and possibly any microcomputers and electrical devices (engines, electricity, etc.). A distance of several meters from TV and computer monitors should be considered as well.

The best method to align a longwave antenna is to turn the antenna slowly until the monitored signal level is minimized, and then turn the antenna by 90° to achieve maximum reception. However, a high signal level alone is not a guarantee for good reception since it can even be caused by electrical noise in the associated frequency range. For standard longwave receivers it is important that the modulation mark is blinking exactly once per second, without intermediate flickering.

DCF77/PZF receivers use correlation techniques to decode the phase modulation provided by DCF77, and with these types of receiver the maximum interference immunity can be found by looking at the autocorrelation parameter displayed in the display menu "PZF-STATE". The displayed value should be as close as possible to 100 % for best reception.

**WARNING!**

Do not mount the antenna without an effective fall arrester!

Danger of death from falling!

- Ensure that you work safely when installing antennas!
- Never work without an effective fall arrester!

**WARNING!**

Do not work on the antenna system during thunderstorms!

Danger of death from electric shock!

- Do not carry out any work on the antenna system or the antenna cable if there is a risk of lightning strike.
- Do not carry out any work on the antenna system if it is not possible to maintain the prescribed safe distance to exposed lines and electrical substations.



8.3.3 DCF77 / PZF Receiver

If both the antenna and the power supply have been connected the system is ready to operate. After power up it takes up to three minutes for the receiver to synchronize, if reception is good enough. A high "Correlation & Field" is an indicator for a good signal quality.

To check the field strength and the signal correlation value, select in the Front Panel "Reference Time → Info PZF → Correlation & Field".

The correlation "State" starts in a "raw" mode, when the receiver tries to find the initial correlation. When good correlation has been found the receiver checks it 20 times: this state is labeled "check" and the correlation value is increased from 1 to 20. If the correlation quality stays good the state changes to the "fine" mode. The signal strength should be 100 or higher.

If no correlation with the incoming signal is possible then the clock changes automatically to DCF77 AM reception mode and tries to decode the second marks.

For further detailed clock configuration, please refer to the Chapter [Clock](#).

8.4 Cable Types

| Antenna Type | Cable Type | Maximum Cable Length |
|----------------------|-------------|----------------------|
| Meinberg GPS Antenna | RG58 | 300 m / 1000 ft |
| Meinberg GPS Antenna | RG213 | 700 m / 2300 ft |
| Multi GNSS Antenna | Belden H155 | 70 m / 230 ft |
| Long Wave Antenna * | RG58 | 300 m / 1000 ft |
| Fiber Optic ** | Fiber Optic | 2000 m / 6500 ft |

* DCF77 (Germany, Middle Europe), MSF (GB), WWVB (US), JJY (Japan)

** Fiber Optic - GOAL - GPS Optical Antenna Link; DOAL - DCF Optical Antenna Link

9 LTOS7 Management and Monitoring

9.1 Via Web GUI

9.1.1 Main Menu

LANTIME M4000
LT-V7-29-105.py.meinberg.de

Reference Time: ✔ | Time Service: ✔ | Network: ✔ | Alarm: ✘ | Active Alarms: 0 Critical, 3 Error | Logged in as: root | Session: 59:56 minutes | Access Level: Super-User | Firmware-Build:

Main | Network | Notification | Security | NTP | PTP | FDM | System | Statistics | Clock | I/O Config | SyncMon | Docs & Support | Logout

LANTIME - Main Menu

General Information

| | | | |
|----------|-------------------|----------------------|--------------|
| LANTIME | M4000 IMS [GNS] | Serial Number | 999910999920 |
| Contact | Gregoire | Serial Number LANCPU | 034811000480 |
| Location | Software+Hardware | Uptime | 1 day 0:11 |

Network Information

| | | | |
|---------------------------------|--|---------------------------------|--|
| Hostname | LT-V7-29-105 | Domain | py.meinberg.de |
| LAN Intf 01: IPv4 (bond0:0) | 1000FDX 172.27.29.105/16 | LAN Intf 01: IPv6 (bond0:0) | 1000FDX Not assigned |
| LAN Intf 02: IPv4 (bond0:2) | 1000FDX Not assigned | LAN Intf 02: IPv6 (bond0:2) | 1000FDX Not assigned |
| LAN Intf 03: IPv4 (lan3:3) | Down Not assigned | LAN Intf 03: IPv6 (lan3:3) | Down Not assigned |
| LAN Intf 04: IPv4 (lan4:4) | Down Not assigned | LAN Intf 04: IPv6 (lan4:4) | Down Not assigned |
| LAN Intf 05: IPv4 (lan5:5) | Down 192.168.29.1/24 | LAN Intf 05: IPv6 (lan5:5) | Down Not assigned |
| PTP Intf: IPv4 (HPS, Slot: I05) | 1000FD Inst 1: 192.168.100.10/24 [PTPv2] Inst 2: 0.0.0.0/0 | PTP Intf: IPv6 (HPS, Slot: I05) | 1000FD Inst 1: Not assigned Inst 2: Not assigned |

Receiver Information

| | | | |
|-----------------|---------------------------------------|----------------------|--|
| 1. Clock State | Sync to GNSS | Receiver information | sync; 51.9824 9.2258 172m; GPS: 12/12SVs GAL: Disabled GLN: 9/10SVs BEI: Disabled; warmed up |
| RSC Information | Manual Mode (Selected Refclock: CLK1) | | |

Meinberg Funkuhren GmbH & Co. KG
 Lange Wand 9
 D - 31812 Bad Pyrmont, Germany

Contact
 Phone: +49 (0) 52 81 / 93 09 - 0
 Fax: +49 (0) 52 81 / 93 09 - 230

Internet
 Website: <https://www.meinbergglobal.com>
 Email: info@meinberg.de

This chapter provides you with configuration options and status information of your LANTIME system accessed via Web GUI. The main page contains an overview of the most important configuration and status parameters for the system.

- Information about LANTIME model and software
- Network information
- Receiver status
- NTP status
- PTP status (option)
- Last messages
- Statistics (NTP/MRS Performance, NTP Access ...)
- Extended Statistics (MRS - external reference input signals)
- Documentation (Manuals), support information

The field in the lower section shows the last messages of the system with a timestamp added. The newest messages are on top of the list. This is the content of the file `/var/log/lantime_messages`, which is created after every start of the system (and is lost after a power off or reboot).

Last messages

```
2022-06-01 12:48:02 UTC: Sync Monitor : ( 172.27.29.227: Normal Operation NTP1-CLK1@172.27.29.227)
2022-06-01 12:48:02 UTC: Sync Monitor : (      PIO-Module: Error: Not reachable Local_PIO-I02-Port-0)
2022-06-01 12:48:02 UTC: Sync Monitor : ( 172.27.29.228: Normal Operation NTP1-CLK1@172.27.29.228)
2022-06-01 12:48:14 UTC: Sync Monitor : ( 172.27.100.108: Error: Not reachable Local_CLK1-NTP-0@172.27.100.108)
2022-06-01 12:48:14 UTC: Sync Monitor : (      PIO-Module: Error: Not reachable Local_PIO-I02-Port-1)
2022-06-01 13:03:33 UTC: LANTIME -> Device Configuration Changed
2022-06-01 13:03:33 UTC: EMail -> Device Configuration Changed
2022-06-01 13:03:33 UTC: VP100/NET Display -> Device Configuration Changed
2022-06-01 13:03:33 UTC: Calculated Power Consumption 37.6W (Available Power 100.0W)
```

By using the navigation on top of the page you can reach a number of configuration menus, which are described in the following chapters.

9.1.1.1 Introduction

To start a http or a secured https session with the Web Interface running on the CPU of your LANTIME system, you need to open your internet browser and type in the IP address of the interface you are using for this connection. Per default configuration https protocol is enabled at each network interface. Http requests are automatically redirected to https.

If you wish to use only one dedicated network interface for management and monitoring and the rest for other services you can find the corresponding configuration options in the Chapter "LTOS Configuration → Via Web → Network" in the submenu [Network Services](#).

If the connection with the LANTIME is established correctly you will be prompted to enter login data to start the web session. Per default the entering user-name/password are: root/timeserver. For security reasons you are advised to change the default credentials after the first login. The corresponding user administration settings can be found in the Chapter "LTOS6 Configuration → Via Web → System" in the submenu [User Management](#).

After entering the correct password, the main menu page of the web interface of a LANTIME system shows up.

The main page contains an overview of the most important configuration and status parameters of the system, including:

- general information (model name, serial number, uptime since last reboot)
- assigned network and PTP interfaces (both in IPv4 or IPv6 configuration)
- receiver status information (sync or not, for GNSS receivers some additional satellite data)
- SHS (Secure Hybrid System) status in redundant receiver configuration, which provides a plausibility mode where the incoming times of both time signals are continuously compared against each other. For more information about the SHS mode and the corresponding settings you can find in Chapter "LTOS6 Configuration → Web GUI → Security → SHS Configuration".

9.1.1.2 How to navigate through the Web Interface

By using the navigation on top of the page you can reach a number of configuration menus, which are described in the following chapters.

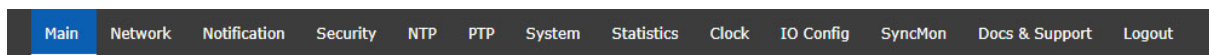

Scrolling down the main page you will find a section containing last log messages generated during the LANTIME operation. The messages in this field are limited to the last 50 and are chronologically ordered. The messages are stored in the file `/var/log/lantime_messages`, which is created after every start of the system (and is lost after a power off or reboot). To view all log messages in the log file you would have to use the CLI (Command Line Interface). For your reference, a list of available CLI commands for LANTIME management and monitoring is provided in the Command Line Reference.

9.1.1.3 Web Interface - Notifications and Alarms

At the top of the main page in the right corner you can find an image of the status LED lamps which are physically located at the front site of a LANTIME system, in models with an integrated front panel unit. When the system is in operation and everything runs as expected, the upper three status LEDs are turned to green and the Alarm indicator is switched off. If you experience after the powering up the system and after the startup has been completed that one or more LEDs are switched on red, please proceed to the Chapter on [Troubleshooting and Alarming](#).

Please note: startup of the system can take a several minutes, depending on the hardware configuration of your system.

Next to the status LEDs you will see displayed all active alarms currently present on a LANTIME with critical and error severity levels. With a mouse click over the alarms you will reach a table of notification events with red marked indicators at the events which triggered the alarms.

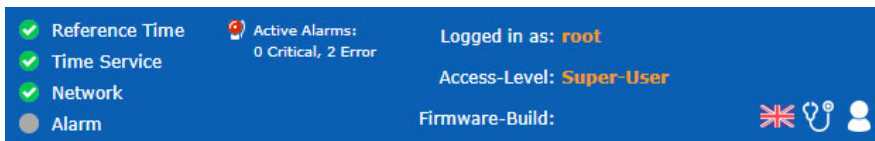

For further information how to eliminate a cause of each individual alarm, proceed to the Chapter on [Troubleshooting and Alarming](#).

Next to the alarm area in the main page there is a field with informational data about your login status and information to which access-level group you belong as a current user. There are three types of users: Super-User, Admin-User and Info-User. The exact definitions of the three different user types and their access-level rights you can find in Chapter "LTOS6 → Web GUI → System → [User Management](#)".

At the top right corner of the main page you can see a few icons. The displayed flag indicates the language pack which is currently activated for the web interface display. For the moment you can choose between English and German languages packs.

Next to the language flag, there is an icon showing a doctor's stethoscope linked with a diagnostic file of the system, which includes all the necessary data for diagnostic and troubleshooting of the device. By clicking this icon a current diagnostic file will immediately start to download for you to save it to your local computer for a further use. The downloading can take up to 60 seconds, depending on the file size, which can be several MB. In the diagnostic file all the data about the system configuration and log messages are stored. The diagnostic file can be also an important tool for the Meinberg support team if you need some help with the configuration or you experience issues which you can not solve on your own. More about the diag file see Chapter "LTOS6 Configuration → via Web GUI → System → [Download Diagnostic File](#)".

The web interface is divided into several dialogue menus, where some of the dialogues (e.g. PTP; IO Config and SyncMon) depend on the hardware components which are integrated in the LANTIME system and only appear in systems with a corresponding configuration. The rest of the dialogues are common to all LANTIME and IMS systems.

You can move between the dialogues by clicking each individual name tag at the top of the menu line. When you click on the Logout tag, your Web session with the LANTIME device will be terminated immediately.

The two dialogues "Main" and "SyncMon" deliver you the status information about the LANTIME system after the last reboot. The rest of the dialogues provide configurations of features for the LANTIME operation and services. The dialogues with feature configurations are presented in a tree structure, where each submenu can be extended into a subtree by clicking at the "+" sign at the beginning of the submenu row. When you open the dialogue, the "+" will turn in "-" and when you click the "-" icon the currently open dialogue will close. You can have a few dialogues open at the same time in the currently selected menu (see the example on the next page).

[Network Services](#)

[Physical Network Configuration](#)

| Interface | LAN0 | LAN1 |
|----------------------------------|-------------------------------------|--------------------------|
| Net Link Mode | AUTO | AUTO |
| Indicate Link on Front Panel LED | <input checked="" type="checkbox"/> | <input type="checkbox"/> |
| Bonding | Assigned to Bond 0 | Assigned to Bond 0 |
| Bonding Status | ACTIVE | PASSIVE |
| IPv6 Mode | Deactivated | Deactivated |
| MAC Address | 00:13:95:2e:39:75 | ec:46:70:02:00:e1 |
| Assigned Virtual Interfaces | 01 | 02 |
| Port Power Status | ON | ON |

Figure: A tree structure of each menu. Opening a subtree by clicking a "+" and closing by "-" at the beginning of the submenu name

Generally, in any configuration menu you are located, when you fill in or edit one or more feature fields at the end you need to confirm the setting by clicking the "Save Settings" button at the bottom of the page. By doing so and if the setting has been carried out successfully, you will receive a dialogue in the Main Menu with a confirmation message written on a green field. At the same time when a new configuration has been applied a log message will appear in the list of last messages in the Main Menu saying: "Device Configuration Changed".

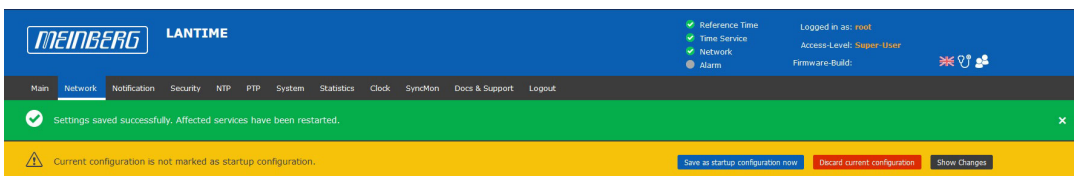

Figure: Settings saved successfully. Affected services have been restarted

A Saving startup configuration dialogue. Options for saving, discarding the current configuration and showing changes between the startup configuration and the current one.

Apart of the configuration message you will receive also an attention notice displayed on a yellow bar, saying: "Current configuration is not yet marked as a startup configuration". This means that you need to confirm the new configuration first by clicking on a "Save as startup configuration now" button if you want to keep it as a startup configuration by the next startup of the system. By clicking this button you will receive another confirmation message saying: "Activate current configuration really as startup configuration?" which you confirm by clicking the "OK" button. The new configuration has now become the startup configuration on your LANTIME system.

On the other hand, if you want to return to the last saved startup configuration then you select "Discard current configuration" button when the message on a yellow bar appears.

Each entry you fill in in the provided dialogues is checked for plausibility for that particular field. If you for example used wrong characters (e.g. letters in the IP Address configuration or any special characters which are not allowed) or you provided an invalid network configuration then you will receive a message displayed on a red bar saying a type of error and at which feature entry it occurred. The false entry will not be accepted by the system, neither the rest of any new settings you may have configured by that time, therefore you will have to redo the configuration steps again. See an example of a warning message if an error by entering a feature occurs.

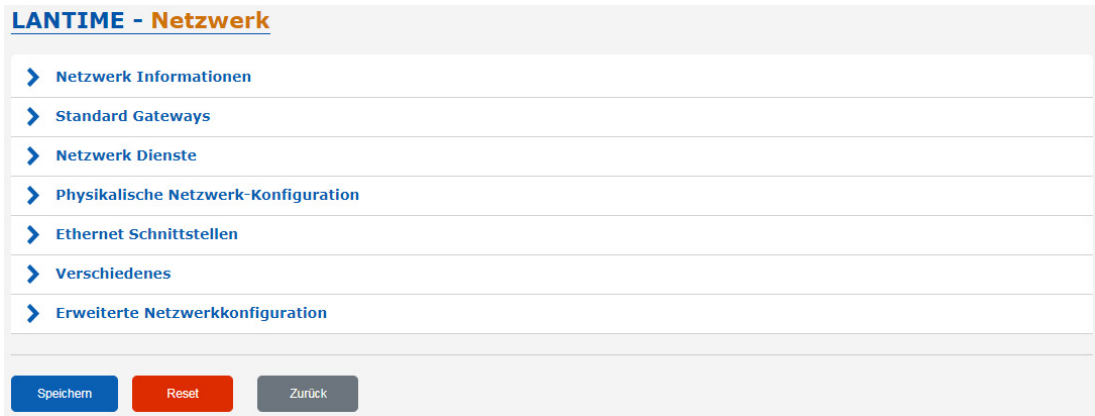

Figure: A display of a warning message with a type of error and indication to which feature it belongs

Allowed signs and special characters which you can use to fill in dialogue boxes you can find in the chapter "Before you Start → Text and Syntax Conventions".

For configuration of the system features now proceed to the dedicated menu which is described in a corresponding chapter.

9.1.2 Network



LANTIME - Netzwerk

- > Netzwerk Informationen
- > Standard Gateways
- > Netzwerk Dienste
- > Physikalische Netzwerk-Konfiguration
- > Ethernet Schnittstellen
- > Verschiedenes
- > Erweiterte Netzwerkkonfiguration

Speichern Reset Zurück

9.1.2.1 Main Network Information



Main Network Information

| | |
|---|--|
| Hostname | Domain |
| <input type="text" value="LT-GREG-29-105"/> | <input type="text"/> |
| Nameserver 1 | Nameserver 2 |
| <input type="text" value="172.16.3.11"/> | <input type="text" value="172.16.3.12"/> |

Hostname

The hostname of the LANTIME is a unique name of a computer in a network. Each IP address configured on the LANTIME is assigned to this hostname.

Domain

This field is used to configure the network domain name. A network domain name is a text-based label easier to memorize than the numerical addresses used in the Internet protocol (e.g. meinberg.de).

Nameserver1

IP Address of the primary DNS Server in the network. The DNS server is used to resolve IP addresses as well as hostnames in a network.

Nameserver2

An alternate nameserver can be defined here.

9.1.2.2 Default Gateways

Default Gateways

IPv4 Gateway

IPv6 Gateway

In this menu you can configure default gateways to be used for IPv4 and IPv6. For a default gateway, a "default" entry is created in the main routing table of a LANTIME. If the LANTIME does not have a direct route or a routing rule to a destination IP, it will always attempt to reach the destination via the default gateway.

IPv4 Gateway Configuration of the default IPv4 gateway.

IPv6 Gateway Configuration of the default IPv6 gateway.

9.1.2.3 Network Services

Network Services

| Service | NTP | HTTP | HTTPS | TELNET | SSH | SNMP | FTP | TIME | DAYTIME | WEBSHELL | MMS | |
|------------------------|--------------------------------------|--------------------------------------|--------------------------------------|------------------------------------|--------------------------------------|------------------------------------|------------------------------------|------------------------------------|------------------------------------|------------------------------------|--------------------------------------|---|
| Interface 01 - lan0:0: | <input checked="" type="checkbox"/> | <input checked="" type="checkbox"/> | <input checked="" type="checkbox"/> | <input type="checkbox"/> | <input checked="" type="checkbox"/> | <input type="checkbox"/> | <input type="checkbox"/> | <input type="checkbox"/> | <input type="checkbox"/> | <input type="checkbox"/> | <input checked="" type="checkbox"/> | + |
| Interface 02 - lan0:1: | <input checked="" type="checkbox"/> | <input type="checkbox"/> | <input checked="" type="checkbox"/> | <input type="checkbox"/> | <input checked="" type="checkbox"/> | <input type="checkbox"/> | <input type="checkbox"/> | <input type="checkbox"/> | <input type="checkbox"/> | <input type="checkbox"/> | <input type="checkbox"/> | + |
| | - | + | - | + | - | + | + | + | + | + | + | |
| Current State: | ✔ | ✔ | ✔ | ✘ | ✔ | ✘ | ✘ | ✘ | ✘ | ✘ | ✔ | |

In this submenu you can enable or disable various services for the existing virtual network interfaces. The +/- buttons can be used to select or deselect entire rows or columns in the matrix.

The following service states are possible:

- A service has been activated for at least one virtual interface and is active.
- Service has not been activated for any virtual interface and is therefore stopped.

The following services are supported by the LANTIME:

| | |
|------------------|---|
| NTP: | Network Time Protocol, UDP Port 123 |
| HTTP: | Hyper Transfer Protocol, TCP Port 80 |
| HTTPS: | Hyper Transfer Protocol Secure, TCP Port 443 |
| TELNET: | Teletype Network, TCP Port 23 |
| SSH: | Secure Shell, TCP Port 22 |
| SNMP: | Simple Network Management Protocol, UDP Port 161 / 162 (Traps) |
| FTP: | File Transfer Protocol, TCP Port 20 |
| TIME: | Time Protocol, TCP/UDP Port 37 |
| DAYTIME: | UDP Port 13 |
| WEBSHELL: | Login to a command line interface of a Lantime via a webbrowser. WEBSHELL works on port 4200. Input in the web browser: [IP/HOSTNAME]: 4200 |
| MMS: | The Manufacturing Message Specification (MMS) standardises the exchange of messages in the production area. |

9.1.2.4 Physical Network Configuration

Physical Network Configuration

| Interface | LAN0 | LAN1 | LAN2 | LAN3 | LAN4 |
|-----------------------------|-------------------------------------|--------------------------|--------------------------|--------------------------|--------------------------|
| Net Link Mode | AUTO | AUTO | AUTO | AUTO | AUTO |
| Monitor Interface | <input checked="" type="checkbox"/> | <input type="checkbox"/> | <input type="checkbox"/> | <input type="checkbox"/> | <input type="checkbox"/> |
| Bonding | Single Connection | Single Connection | Single Connection | Single Connection | Single Connection |
| Bonding Status | | | | | |
| IPv6 Mode | Deactivated | Activated | Deactivated | Deactivated | Deactivated |
| MAC Address | ec:46:70:03:0f:9f | ec:46:70:03:0f:a0 | ec:46:70:00:c8:2e | ec:46:70:00:c8:2f | ec:46:70:00:c8:30 |
| Assigned Virtual Interfaces | 01 | 02 | 03 | 04 | 05 |
| Port Power State | ON | ON | ON | ON | ON |
| Link State | 1000FDX | 1000FDX | Down | Down | Down |

| Interface | LAN5 |
|-----------------------------|--------------------------|
| Net Link Mode | AUTO |
| Monitor Interface | <input type="checkbox"/> |
| Bonding | Single Connection |
| Bonding Status | |
| IPv6 Mode | Deactivated |
| MAC Address | ec:46:70:00:c8:31 |
| Assigned Virtual Interfaces | 06 |
| Port Power State | ON |
| Link State | Down |

Net Link Mode dropdown menu:

- AUTO
- 10 MBIT HALF DUPLEX
- 10 MBIT FULL DUPLEX
- 100 MBIT HALF DUPLEX
- 100 MBIT FULL DUPLEX
- 1000 MBIT FULL DUPLEX

IPv6 Mode dropdown menu:

- Deactivated
- Activated
- Activated with Autoconf

Bonding dropdown menu:

- Single Connection
- Assigned to Bond 0
- Assigned to Bond 1
- Assigned to Bond 2
- Assigned to Bond 3
- Assigned to Bond 4
- Assigned to PRP 0
- Assigned to PRP 1
- Assigned to PRP 2
- Assigned to PRP 3
- Assigned to PRP 4

Net Link Mode

Allows you to configure the network connection mode of the interface. You can choose among supported link modes of the respective physical interface.

The default value AUTO (Autonegotiation) can remain unchanged under normal circumstances. Autonegotiation refers to a method which allows two interconnected Ethernet devices to independently negotiate the maximum possible transmission speed and the duplex method and to configure them accordingly.

Monitor Interface

As soon as one of the selected network ports has no link, this status will be indicated by a red "Network" LED on the front panel and the "Network Link Down" event will be reported. If a network link is available on all selected ports, the "Network" LED on the front panel will light up green.

Bonding

Here, 2 or more physical network ports can be grouped into a bond (group). The LANTIME supports the bonding modes "Active - Backup" and "LACP". The mode to be used can be selected in the submenu "Network → Miscellaneous → Bonding-Mode". For more information about how the two modes work, see the "Miscellaneous" submenu.

PRP

PRP stands for Parallel Redundancy Protocol and is defined in the standard IEC 62439-3 since 2010. PRP is Layer-2 based and has been developed for computer networks which are in need of a reliable solution regarding high availability and operational functionality. A LANTIME with two or more interfaces, running firmware 6.22.001 or higher, has the ability to act as a DAN ("Dual Attached Node" - a device which is connected to both redundant networks).

| Interface | LAN0 | LAN1 |
|-----------------------------|-------------------------------------|---|
| Net Link Mode | AUTO | AUTO |
| Monitor Interface | <input checked="" type="checkbox"/> | <input type="checkbox"/> |
| Bonding | Assigned to PRP 1 | Single Connection |
| Bonding Status | | <ul style="list-style-type: none"> Single Connection Assigned to Bond 0 Assigned to Bond 1 Assigned to Bond 2 Assigned to Bond 3 Assigned to Bond 4 Assigned to PRP 0 Assigned to PRP 1 Assigned to PRP 2 Assigned to PRP 3 Assigned to PRP 4 |
| IPv6 Mode | Deactivated | |
| MAC Address | ec:46:70:03:0f:9f | |
| Assigned Virtual Interfaces | 01 | |
| Port Power State | ON | |
| Link State | 1000FDX | 1000FDX |

As of LANTIME firmware version 7.0, PRP can also be conveniently set via the web interface menu "Network → Physical Network Configuration". Select the same PRP group for at least two interfaces in the drop-down menu "Bonding".

IPv6 Mode

Activation or deactivation of the IPv6 protocol.

MAC Address

Media Access Control, shows the MAC address of the given physical interface.

Assigned Virtual Interfaces

Indicates which virtual interfaces are assigned to the given physical interface.

Port Power Status

This feature is available in IMS systems, where several physical interfaces can be available. The port power status is an indicator if a particular physical interface is powered on or off.

Link Status

The Link Status indicates the speed detected by the respective network interface.

9.1.2.5 Network Interfaces

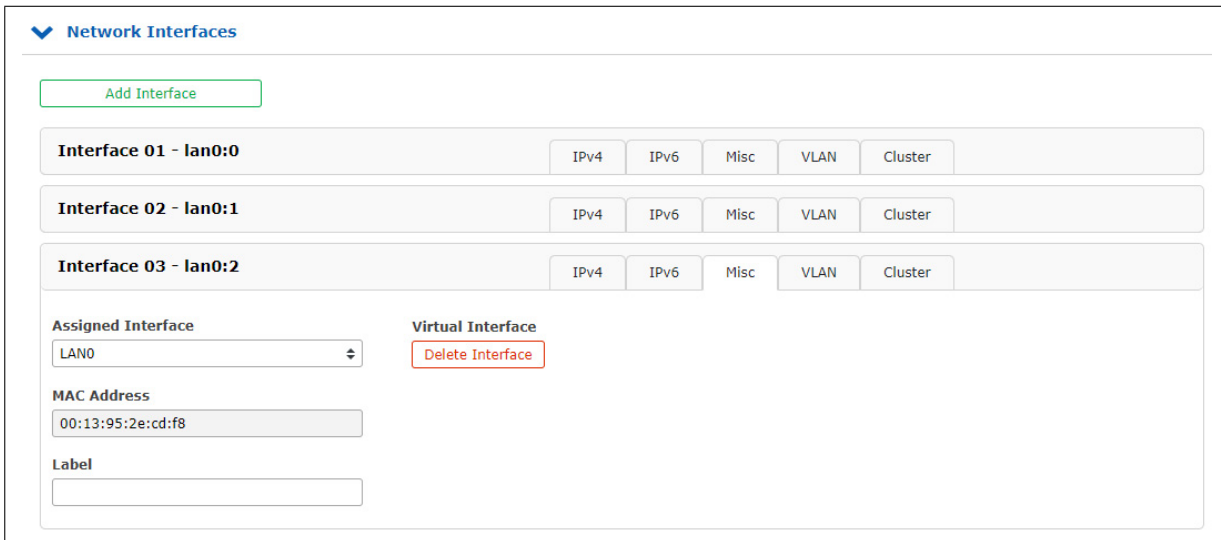

In this menu the virtual interfaces of the LANTIME are managed. Up to 99 virtual interfaces can be assigned to the available physical ports. The name of the virtual interface consists of a consecutive number of a physical interface and the number of a virtual interface (starting with zero).

The example above shows a configuration in which a total of three virtual interfaces are assigned to the physical interface **LAN0**, namely **lan0:0**, **lan0:1** and **lan0:2**.

In the case of an active bond, the physical interface is replaced by the name of the bonding group, for example **bond0:0**.

Add interface

With this button a new virtual interface can be created. The new interface is assigned by default to the physical port lan0 and is added at the end of the row of the existing virtual interfaces. The assignment can be changed in the "Miscellaneous" tab.

Submenu IPv4:

In this submenu the IPv4 parameters can be configured or the current configuration given by the DHCP server can be displayed.

TCP/IP address: IPv4-Address of the given interface.

Netmask: Configuration of the subnetmask for the given interface.

Gateway: Configuration of an interface-specific gateway. This setting must be made only if the IP of the interface is NOT in the same subnet as the default gateway and the cross-network traffic in the subnet should be enabled via the gateway.

Enable DHCP-Client: With this setting a DHCP client can be activated for the automatic assignment of the network configuration by a DHCP server.

Submenu IPv6:

In this menu the IPv6 parameters can be configured or the configuration given by a DHCP server can be displayed.

TCP/IP address: Ipv6-Address of the given interface

Enable DHCP-Client: With this setting a DHCPv6 client can be activated for the automatic assignment of the network configuration by a DHCPv6 server.

Submenu Misc:

Assigned Interface: Determines which physical network is associated with the currently selected virtual interface.

"Virtual Interface"

Delete Button: Deletes the currently selected virtual interface.

MAC Address: Displays the MAC address of the assigned physical network port

Label: Individual text-description of the interface (alias).

Submenu VLAN:

Enable VLAN Option: Activation of the tagged VLAN function for the selected virtual interface.

VLAN-Tag (0-4094): VLAN tags from 0-4094 can be entered here. The selected tag is inserted into the data area of an Ethernet packet.

Priority: PCP (Priority Code Point). Sets the priority of an Ethernet frame. Priorities can be set between a low priority, value 1 and a high priority, value 7.

The Priority value 0 corresponds to the Best Effort.

Submenu Cluster:

The Cluster mode is a method for providing redundant time synchronization by grouping (clustering) multiple LANTIME NTP servers. Within this group, the participating NTP servers continuously exchange status and quality information with each other. The status information is compared among each other and by a special algorithm a decision is made, which of the NTP servers should act as a current MASTER in the network. The rest of the group acts as SLAVE and stays passive as a backup. If the current master loses its synchronization source or any other failure occurs, another NTP server from the cluster takes over the master role. The current master responds to requests from NTP clients via a common cluster IP. Even if the master is replaced by another NTP server, this IP does not change.

The configuration of a NTP cluster is useful if at the side of NTP clients only one IP address for an external NTP server can be configured and redundancy is still required.

The current master is selected according to the following parameters in this order:

1. NTP status (sync, not sync);
2. Priority (configurable by the user, the lowest value has the highest priority, default = 0);
3. Ref-Clock Type - GNSS receivers such as GPS have the highest rating;
4. Ref-Clock Status (sync, not sync).

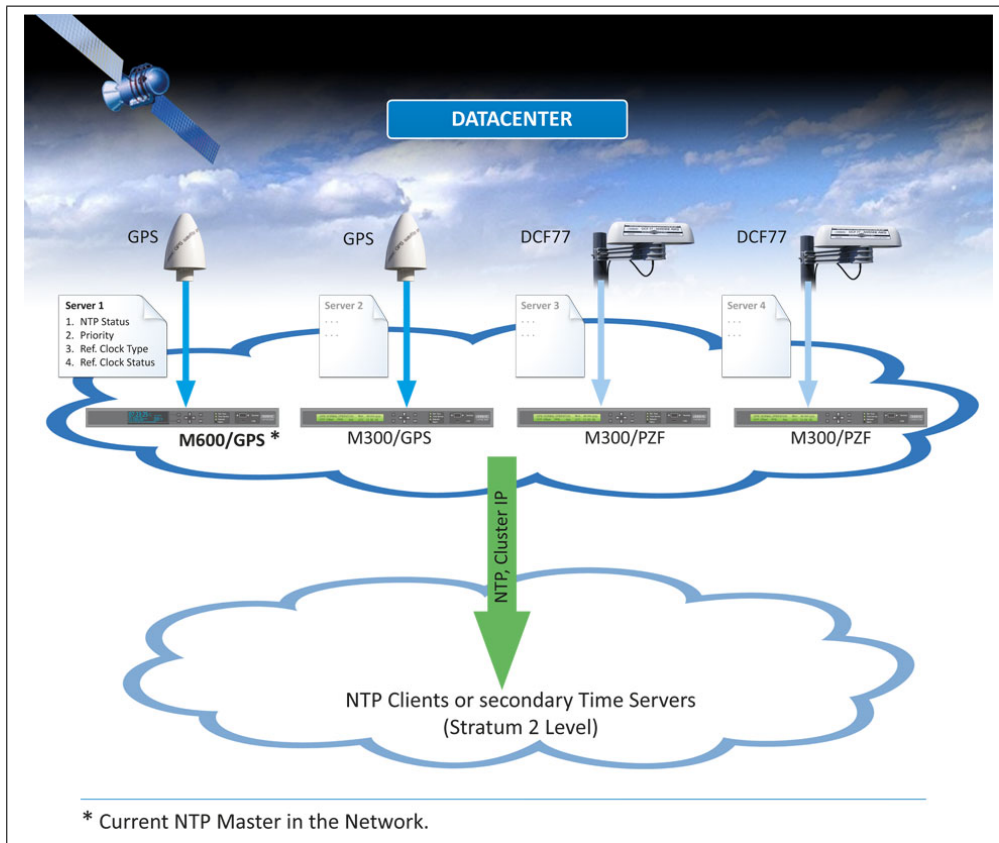

9.1.2.6 Cluster Configuration

Enable Cluster Option: The cluster function can be activated via this selection box.

Mode: The cluster members can share their status information either via multicast or unicast messages. For multicast, a cluster multicast address 239.192.0.1 is used by default. This setting can be changed in the menu "Network → Miscellaneous". In addition, the network port which is used for the cluster communication can be changed there. By default, port 7000 is used for the cluster messages.

TCP/IP Address: IP address of the NTP cluster interface. The same cluster IP needs to be configured on all cluster members. It is recommended to configure a cluster IP in the same subnet as the corresponding virtual interface.

Netmask: Netmask Configuration for the cluster interface.

Priority: The priority set here is taken into account when the MASTER is determined by the cluster algorithm. The lowest value has the highest priority.

Example configuration for a multicast cluster:

Interface 01 - lan0:0

IPv4 IPv6 Misc VLAN Cluster

Enable Cluster Option

Mode

Multicast Unicast

TCP/IP address: 198.27.50.0

Netmask: 255.255.0.0

Priority: 0

Example configuration for an unicast cluster:

Interface 02 - lan1:1

IPv4 IPv6 Misc VLAN Cluster

Enable Cluster Option

Mode

Multicast Unicast

Other IPv4-Member

198.27.50.10
198.27.50.20

TCP/IP address: 198.27.50.0

Netmask: 255.255.0.0

Priority: 0

In the Unicast cluster, the IP addresses of the cluster members must be entered in the "Other IPv4 Member" field.

9.1.2.7 Miscellaneous

▼ Miscellaneous

| | |
|--|-----------------------------------|
| Cluster Multicast Address | Cluster Port |
| <input type="text" value="239.192.0.1"/> | <input type="text" value="7000"/> |
| DSCP NTP Classification | |
| <input type="text" value="Deactivated"/> | |
| Bonding-Mode | |
| <input type="text" value="ACTIVE-BACKUP"/> | |

Cluster Multicast Address:

Configuration of the cluster multicast address. Via this address, LANTIME cluster members exchange their status messages if Multicast mode is selected.

Cluster Port:

Configuration of a free network port for the cluster communication. Per default this port is set to 7000.

DSCP NTP Classification:

DSCP = Differential Service Code Point. DSCP is generally a method for prioritizing the traffic via IP. On the LANTIME, this setting allows the NTP packets to be assigned to a certain traffic class. The DSCP is 6 bits in length, enabling $2^6 = 64$ different values (0 to 63). These are the default DSCP values. The information about the traffic class is inserted into a header of a IPv4 packet. Routers can evaluate this information and handle the NTP packets as prioritized.

Bonding-Mode:

In the menu "Network → Physical Network Configuration", two or more physical network ports can be grouped into a bond (group). The Bonding Mode is used to configure either the "ACTIVE BACKUP" or the "LACP" mode (Link Aggregation Control Protocol), which are supported on the LANTIME.

ACTIVE-BACKUP:

One physical interface in the bonding group acts as an "active slave". All network traffic of a LANTIME Bond runs through this interface. The other physical interfaces in the bonding group are passive. In case the current active interface loses the network connection, the passive interface seamlessly takes over. Even the MAC address of the network port remains unchanged.

LACP: LACP (802.3ad) allows a combination of multiple physical connections to a logical one. This results in a load sharing and, in addition, increases the safety in case of a failure compared to "Active Backup". It is important that other connected network devices also support LACP and the network ports are configured accordingly.

9.1.2.8 Extended Network Configuration

The Extended Network Configuration are not enabled for security reasons. This function can be subsequently enabled / controlled via an SSH connection in `/etc/mbg/msc.cfg` with the "DISABLE SCRIPT" parameter.

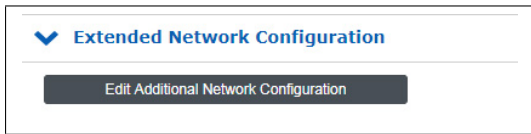

In the Extended Network Configuration, a bash script can be edited, which is executed automatically each time the LANTIME is rebooted or a network-related configuration changes.

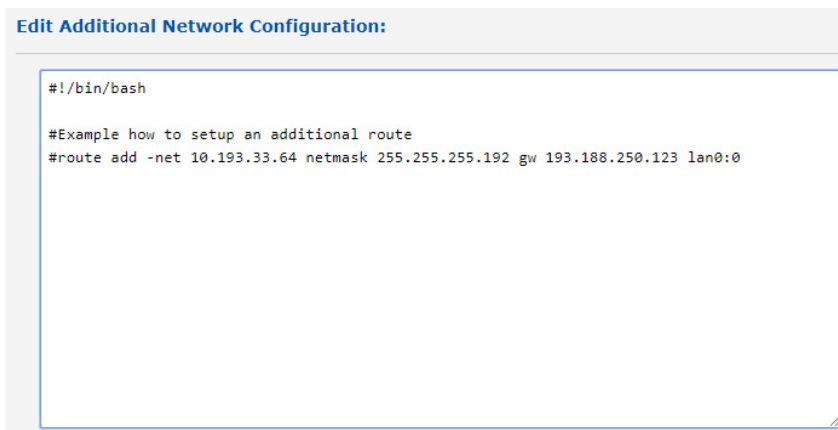

9.1.3 Notification

LANTIME - Notification

- External Syslog Server
- Email Information
- SNMP Trap Receiver Information
- VP100/NET Display Information
- User Defined Notification
- Miscellaneous
- Notification Events

Save Settings
Reset Changes
Back

9.1.3.1 External Syslog Server

All information which is written into SYSLOG (/var/log/auth.log etc.) on the LANTIME, can also be forwarded to a remote server.

External Syslog Server

| | | |
|--|--------------------------------|--|
| Syslog Address 1 <input type="text"/> | Minimum Log Level Emergency | Transport Protocol UDP |
| Port 514 | | |
| Forward Syslog | Timezone Etc/UTC | <input type="checkbox"/> TLS Peer Verify |

•
•
•

| | | |
|--|--------------------------------|--|
| Syslog Address 4 <input type="text"/> | Minimum Log Level Emergency | Transport Protocol UDP |
| Port 514 | | |
| Forward Syslog | Timezone Etc/UTC | <input type="checkbox"/> TLS Peer Verify |

Syslog-Address(es):

You can enter up to 4 external Syslog Servers via the webinterface. As standard, the reachability of the Syslog Server is checked via Ping/ICMP. If the registered Syslog Server cannot be reached, it will not be entered into the Syslog configuration file `/etc/syslog-ng/syslog-ng.conf`. In case ICMP is not allowed in the network, due to firewall regulations, you can switch off the pingcheck via the manual network configuration. To proceed navigate as described down below:

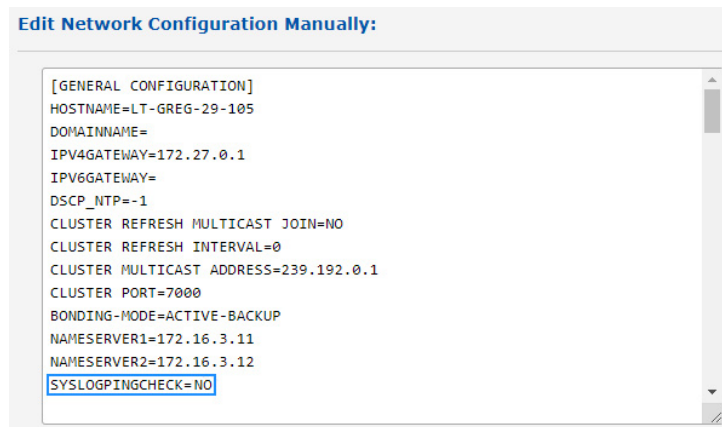

"System Page → Services and Functions → Manual Configuration → Network Configuration": Enter the value "NO" for the Parameter "SYSLOGPINGCHECK" and save the new settings.

Minimum Log Level:

Log Level Configuration

Transport-Protocol:

Transport - Protocol Configuration:

- UDP connectionless transmission
- TCP connection oriented
- TLS can be selected to securely transport the logging information to an external syslog server.

Port:

Configuration of the network port which is to be used. As default, IANA has registered port 514 for syslog messages.

Forward:Timezone:

Specifies the time zone of forwarded log events.

TLS Peer Verify:

The TLS Peer Verify option specifies whether the logging server's certificate should be verified. An authentic connection is only possible with this setting. If this option is active, make sure that a root CA certificate for the syslog server has been uploaded under "Security → Certificates → CA Certificates" has been uploaded. For information on uploading CA certificates, see chapter [CA Certificates](#).

Syslog

Everything that is logged internally to the `/var/log/messages` file is also sent to the configured syslog server (of course considering the configured log level).

Format:

```
Mar 22 15:35:56 su-rims1-1 PAM-tacplus[3431]: user not authenticated by TACACS+
```

Notification/Text

Only the events that are listed in the event list under "Notification → Notification Events" are sent to the syslog server.

Format:

```
DAEMON.INFO: Mar 22 14:39:55 su-rims1-1 ext_syslog_cfg_text: Device  
Configuration Changed
```

Notification/Splunk

Same as before, only the format differs:

Format:

```
Mar 22 14:41:46 su-rims1-1 ext_syslog_cfg_splunk: msg_nr=20,  
msg_name=Device Configuration Changed, msg_txt=, add_txt=
```

Notification/JSON

Same as before, only the format differs:

Format:

```
Mar 22 14:43:57 su-rims1-1 ext_syslog_cfg_json: { "msg_nr": "20",  
"msg_name": "Device Configuration Changed", "msg_txt": "", "add_txt": ""  
}
```

9.1.3.2 Email Information

The LANTIME is able to inform about certain system events via e-mail. In the menu "Email Information" you can make the necessary settings. In the submenu "Notifications" you can select the system events, for which the LANTIME has to send out a notification e-mail.

- Recipient:** E-mail of the desired recipient.
- Sender:** Address of the sender.
- Smarthost:** To send the e-mails you require a smarthost (relay-server). Please enter the server address here.
- Port:** Network port configuration. Default setting is 25, because the SMTP (Simple Mail Transfer Protocol) uses TCP Port 25 as standard.
- Activate Authentication:** Many mail servers require a valid authentication. (Checkbox) Please check mark the box to activate it.
- Username/ Password:** Please enter a valid access for the e-mail server.
- Additional E-mail Recipients:** Configuration of additional e-mail recipients.

9.1.3.3 SNMP Trap Receiver

The LANTIME is able to inform about certain system events with the help of SNMP traps. In the menu "SNMP Trap Receiver" you can configure up to 4 trap receiver. In the submenu "Notifications" you can select the system events, for which the LANTIME has to send an SNMP Trap.

SNMP Trap Receiver Information

| | | |
|-----------------------------|--------------------------|----------------|
| SNMP Trap Receiver 1 | Community | Version |
| <input type="text"/> | <input type="text"/> | SNMP v3 ▼ |
| SNMP Trap Receiver 2 | Community | Version |
| <input type="text"/> | <input type="text"/> | SNMP v3 ▼ |
| SNMP Trap Receiver 3 | Community | Version |
| <input type="text"/> | <input type="text"/> | SNMP v3 ▼ |
| SNMP Trap Receiver 4 | Community | Version |
| <input type="text"/> | <input type="text"/> | SNMP v3 ▼ |
| Number of Retries | Timeout (seconds) | |
| 3 ▼ | 3 ▼ | |

SNMP Trap Receiver: IP address or hostname of the SNMP trap receiver.

Community: SNMP Read Community of the Trap Receiver.

Version: SNMP version to use.

Number of Retries: Specifies the value a lantimes retries to send a Trap.

Timeout: Connection timeout value.

9.1.3.4 VP100/NET Display Information

The Meinberg VP100 / 20NET network display is used to display the time and date. This display has an integrated network card and a SNTP client. The time is taken from any NTP time server via the NTP protocol and thus the internal clock is adjusted. This display can also display any characters as scrolling text. All LANTIME alarm messages can be displayed as text messages on the display. In the submenu "Notifications", you can select the system events which are to be sent to the display by the LANTIME. A message appears three times in succession as a scrolling text on the display.

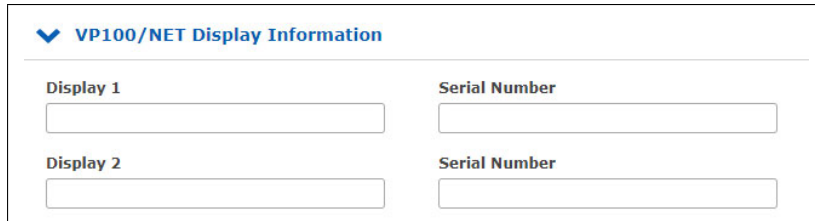

The screenshot shows a configuration window titled "VP100/NET Display Information". It contains two rows of input fields. The first row is labeled "Display 1" and "Serial Number". The second row is labeled "Display 2" and "Serial Number". Each label is positioned above its respective input field.

Display: IP Address of the network display.

Serial number: You have to enter the correct serial number of the display here.
The serial number is displayed after pressing the red SET button four times.

9.1.3.5 Notifications

▼ **User Defined Notification**

[Edit user defined notification](#)

User-defined Notifications

A freely definable script which should be executed when certain system events occur, can be created via the "User-defined notification" menu item. This script can be viewed and edited via the button "Notification Edit". Upon delivery this script contains a few comments:

```

Edit user defined notification:

#!/bin/bash
# Example:
# $1 : notification message number
# $2 : standard notification message text
#
#output the message to file
#echo $1 $2 > /notification.txt
#
#passing message to binary
#/mnt/flash/my_bin $1 $2
#
#sending an email
#echo -e "Subject: $2\n\n $2" | sendmail -f Lantime info@meinberg.de
#
#add message to syslog
    
```

In the submenu "Notification Events", you can select the system events on which the script should be executed.

▼ **Notification Events**

| Event | Type | Status | Triggered | Triggers | | | | | |
|----------------------|----------|---|-----------|--------------------------|--------------------------|--------------------------|--------------------------|--------------------------|---|
| | | | | EMAIL | SNMP | DISP | USER | ALED | |
| Normal Operation | Info | | | <input type="checkbox"/> | <input type="checkbox"/> | <input type="checkbox"/> | <input type="checkbox"/> | <input type="checkbox"/> | + |
| NTP Not Sync | Error | | | <input type="checkbox"/> | <input type="checkbox"/> | <input type="checkbox"/> | <input type="checkbox"/> | <input type="checkbox"/> | + |
| NTP Sync | Info | | 🚨 4d ago | <input type="checkbox"/> | <input type="checkbox"/> | <input type="checkbox"/> | <input type="checkbox"/> | <input type="checkbox"/> | + |
| NTP Stopped | Critical | | | <input type="checkbox"/> | <input type="checkbox"/> | <input type="checkbox"/> | <input type="checkbox"/> | <input type="checkbox"/> | + |
| Trusted Source OK | Info | <input type="text" value="1"/> <input type="text" value="2"/> | | <input type="checkbox"/> | <input type="checkbox"/> | <input type="checkbox"/> | <input type="checkbox"/> | <input type="checkbox"/> | + |
| Trusted Source Error | Error | <input type="text" value="1"/> <input type="text" value="2"/> | | <input type="checkbox"/> | <input type="checkbox"/> | <input type="checkbox"/> | <input type="checkbox"/> | <input type="checkbox"/> | + |
| | | | | + | + | + | + | + | |

Autorepeat Event: Max. Number of Repetition:

Miscellaneous

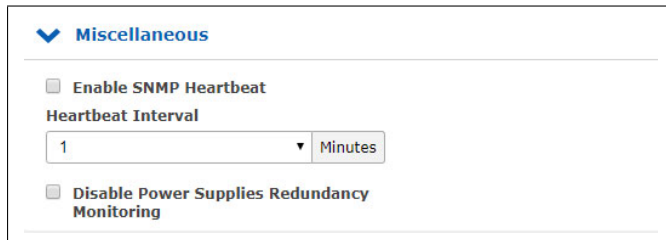

▼ Miscellaneous

Enable SNMP Heartbeat

Heartbeat Interval

1 Minutes

Disable Power Supplies Redundancy Monitoring

The network heartbeat describes a function, with which the LANTIME cyclically sends an SNMP trap to the configured SNMP trap receivers to report itself as "alive" and "active".

The SNMP OID of the trap is: 1.3.6.1.4.1.5597.30.3.0.88 (mbgLtNgTrapHeartbeat).

Activate Heartbeat: The heartbeat can be activated via this checkbox

Heartbeat-Intervall (m): Heartbeat interval in minutes.

9.1.3.6 Notification Events

The "Notification Events" submenu provides an overview of all system events that may occur during LANTIME operation. The checkboxes can be used to configure external alarms for each event. The following information channels are available:

| Event | Type | State | Triggered | Triggers | | | | | |
|---------------------------------|----------|---|---------------------------------------|--------------------------|--------------------------|--------------------------|--------------------------|--------------------------|---|
| | | | | EMAIL | SNMP | DISP | USER | ALED | |
| Normal Operation | Info | | 🕒 9d 02h 15m 02s ago | <input type="checkbox"/> | <input type="checkbox"/> | <input type="checkbox"/> | <input type="checkbox"/> | <input type="checkbox"/> | + |
| NTP Not Sync | Error | | | <input type="checkbox"/> | <input type="checkbox"/> | <input type="checkbox"/> | <input type="checkbox"/> | <input type="checkbox"/> | + |
| NTP Sync | Info | | 🕒 9d 02h 15m 14s ago | <input type="checkbox"/> | <input type="checkbox"/> | <input type="checkbox"/> | <input type="checkbox"/> | <input type="checkbox"/> | + |
| NTP Stopped | Critical | | | <input type="checkbox"/> | <input type="checkbox"/> | <input type="checkbox"/> | <input type="checkbox"/> | <input type="checkbox"/> | + |
| NTP Offset Limit exceeded | Error | | | <input type="checkbox"/> | <input type="checkbox"/> | <input type="checkbox"/> | <input type="checkbox"/> | <input type="checkbox"/> | + |
| NTP Offset Limit OK | Info | | | <input type="checkbox"/> | <input type="checkbox"/> | <input type="checkbox"/> | <input type="checkbox"/> | <input type="checkbox"/> | + |
| System Reboot | Action | | 🕒 Last: Mon Aug 8 11:14:59 2022 | <input type="checkbox"/> | <input type="checkbox"/> | <input type="checkbox"/> | <input type="checkbox"/> | <input type="checkbox"/> | + |
| CLK1 Not Responding | Critical | | | <input type="checkbox"/> | <input type="checkbox"/> | <input type="checkbox"/> | <input type="checkbox"/> | <input type="checkbox"/> | + |
| ⋮ | | | | | | | | | |
| Power Supply Failure | Critical | 1 2 | | <input type="checkbox"/> | <input type="checkbox"/> | <input type="checkbox"/> | <input type="checkbox"/> | <input type="checkbox"/> | + |
| Power Supply OK | Info | 1 2 | 🕒 Last Event: Mon Aug 8 11:14:59 2022 | <input type="checkbox"/> | <input type="checkbox"/> | <input type="checkbox"/> | <input type="checkbox"/> | <input type="checkbox"/> | + |
| Power Consumption Overload | Critical | | | <input type="checkbox"/> | <input type="checkbox"/> | <input type="checkbox"/> | <input type="checkbox"/> | <input type="checkbox"/> | + |
| Power Consumption OK | Info | | 🕒 9d 02h 15m 45s ago | <input type="checkbox"/> | <input type="checkbox"/> | <input type="checkbox"/> | <input type="checkbox"/> | <input type="checkbox"/> | + |
| Power Redundancy not guaranteed | Warning | | | <input type="checkbox"/> | <input type="checkbox"/> | <input type="checkbox"/> | <input type="checkbox"/> | <input type="checkbox"/> | + |
| Power Redundancy activated | Info | | 🕒 9d 02h 15m 45s ago | <input type="checkbox"/> | <input type="checkbox"/> | <input type="checkbox"/> | <input type="checkbox"/> | <input type="checkbox"/> | + |
| Sync Monitor | Action | | 🕒 Last: Fri Aug 12 07:34:26 2022 | <input type="checkbox"/> | <input type="checkbox"/> | <input type="checkbox"/> | <input type="checkbox"/> | <input type="checkbox"/> | + |
| Sync Monitor Alert | Error | | 🕒 9d 02h 12m 28s ago | <input type="checkbox"/> | <input type="checkbox"/> | <input type="checkbox"/> | <input type="checkbox"/> | <input type="checkbox"/> | + |
| ⋮ | | | | | | | | | |
| Port Ok | Info | 1 2 3 4 5 6 7 8 9 10 11 12 13 14 15 16 17 18 | | <input type="checkbox"/> | <input type="checkbox"/> | <input type="checkbox"/> | <input type="checkbox"/> | <input type="checkbox"/> | + |
| Fallock: user banned | Action | | | <input type="checkbox"/> | <input type="checkbox"/> | <input type="checkbox"/> | <input type="checkbox"/> | <input type="checkbox"/> | + |
| | | | | + | + | + | + | + | |
| Reset IMS Error | | | | | | | | | |
| Autorepeat Event | | Max. Number of Repetitions | | | | | | | |
| Never | | 1 | | | | | | | |

EMAIL: Sends an e-mail based on the e-mail configuration (see chapter "E-mail Information")

SNMP: Sends an SNMP Trap to the configured SNMP Trap (see chapter "SNMP Trap Receivers")

DISP: Shows the notifications on the configured network displays (see chapter "VP100/NET Display Information")

USER: Activates the user-defined script (see chapter "Notifications")

ALED: When the event occurs, the alarm LED of the LANTIME will light up

RELAY: When the event occurs, the error relay at the LANTIME is set to ERROR (see chapter "Error Relays")



1) Information; 2) Alarm; 3) Last change

Reset IMS Error

Reset IMS Error

Autorepeat Event
Every Hour

Max. Number of Repetition
3

Removing an IMS module triggers a permanent error in the system. If modules are intentionally removed, the "**Reset IMS Error**" button at the bottom of the event table is available in the "Notifications" submenu. With this button all registered IMS errors can be reset.

Automatic Event Repeat: An interval can be configured, with which notifications are sent again.

Max. Number of Repetitions: The number of repetitions can be limited by this parameter.

Example:

If the "Autorepeat Event" is set to "Every hour" and the "Max. number of Repetition" is set to the value 3, then the system will send a total of four notifications. The first one when the event occurs. Then one notification per hour for the next three hours.

9.1.3.7 Overview for all Events

| Event | Severity Levels (according to X.733) | Description |
|------------------------------|--------------------------------------|---|
| Normal Operation | Info | Indicates normal operation of the LANTIME |
| NTP Not Sync | Error | NTP Service is not sync -> NTP Messages |
| NTP Sync | Info | NTP service is successfully synchronized |
| NTP Stopped | Critical | NTP service stopped -> NTP Messages |
| NTP Offset Limit exceeded | Error | Maximum NTP offset value has been exceeded -> Sync Monitoring |
| NTP Offset Limit OK | Info | Maximum NTP offset not exceeded -> Sync Monitoring |
| System Reboot | Action | The system has restarted |
| CLK[NR] Not Responding | Critical | Receiver module is not responding -> Ref. Clock Messages |
| CLK[NR] Not Sync | Error | Receiver module is not sync -> Ref. Clock Messages |
| CLK[NR] Sync | Info | Receiver module is synchronous to its time source |
| Antenna Faulty | Error | No antenna or sufficient signal was detected -> Ref. Clock Messages |
| Antenna Reconnect | Info | Antenna / signal was detected by the LANTIME |
| Antenna Short Circuit | Error | Short circuit at the antenna connection -> Ref. Clock Messages |
| Device Configuration Changed | Action | Software configuration of the LANTIME has been changed |

Table: All Notification Events

| Event | Severity Levels (according to X.733) | Description |
|---------------------------------|--------------------------------------|---|
| Leap Second Announced | Info | A leapsecond was announced |
| SHS Time Limit OK | Info | The set SHS time limit value has not been exceeded |
| SHS Time Limit Warning | Warning | The set threshold for an SHS warning has been exceeded |
| SHS Time Limit Error | Critical | The set threshold for an SHS error has been exceeded -> SHS Configuration |
| Power Supply Failure | Critical | Error detected on a power supply -> Safety During Operation |
| Power Supply OK | Info | Power supply ready for operation |
| Power Consumption Overload | Critical | Overload of the power supply unit(s). There are not enough power supply units in use -> Redundant Power Supply |
| Power Consumption OK | Info | The power supplies used provide sufficient power for the system |
| Power Redundancy not guaranteed | Warning | In case of failure of a power supply unit, trouble-free operation is no longer guaranteed -> Redundant Power Supply |
| Power Redundancy activated | Info | Normal operation is ensured even after the failure of a power supply unit |
| Sync Monitor | Action | Sync Monitor limits were exceeded |
| Sync Monitor Alert | Error | SyncMon malfunction - monitored network node is unreachable -> Error Logs |
| Sync Monitor OK | Info | No malfunction detected in Sync Monitor |

Table: All Notification Events

| Event | Severity Levels (according to X.733) | Description |
|-------------------------------------|--------------------------------------|--|
| MRS Source: Limit Exceed | Error | Set MRS limits have been exceeded -> Ref. Clock Messages |
| MRS Source: No Signal | Warning | A configured MRS time source is no longer available -> Ref. Clock Messages |
| MRS Source: Signal Detected | Info | A configured MRS time source is available |
| MRS Source: Selected Signal Changed | Action | The active MRS source has changed |
| MRS Source: Invalid Signal | Warning | A configured MRS source provides an invalid signal |
| MRS Source: Signal OK | Info | The configured MRS source provides a valid signal |
| Network Link Down | Error | No network connection on one of the LAN ports -> Network Messages |
| Network Link Up | Info | Network connection detected on the LAN port |
| PTP Link Down | Error | No network connection on the PTP network port |
| PTP Link Up | Info | Network connection detected on the PTP network port |
| PTP State Changed | Info | The current PTP status has changed |
| PTP Error | Error | A PTP error has been detected -> PTP Global Status |
| Low System Resources | Warning | Low system resources detected |
| Sufficient System Resources | Info | System resources restored |

Table: All Notification Events

| Event | Severity Levels (according to X.733) | Description |
|--|--------------------------------------|--|
| Fan Failure | Critical | An error has been detected on a fan -> Miscellaneous Messages |
| Fan OK | Info | No mistakes on installed fans |
| Certificate Expired | Error | HTTPS certificate has expired -> Certificates |
| HTTPS Certificate Expiration Warning (expiration in 90, 60 or 30 days) | Warning | HTTPS certificate expire in 90, 60 or 30 days -> Certificates |
| Self Signed HTTPS Certificate In Use | Warning | The certificate used is self-signed and does not come from an official certification authority -> Certificates |
| Oscillator Adjusted | Info | Internal oscillator runs stably and is completely adjusted |
| Oscillator Not Adjusted | Warning | Internal oscillator is not adjusted -> Ref. Clock Messages |
| Cluster Master Changed | Info | The master of a LANTIME NTP cluster has changed -> Menu: Network |
| Cluster Falseticker detected | Warning | An NTP falseticker was detected in the cluster compound |
| Cluster Falseticker cleared | Info | Previously detected cluster falseticker is back in order |
| IMS Error | Error | An error has been detected on an IMS module -> Miscellaneous Messages |
| IMS OK | Info | IMS module is error-free |
| Trusted Source OK | Info | The source selected as trusted is in the configured offset range -> Extended Options |

Table: All Notification Events

| Event | Severity Levels (according to X.733) | Description |
|------------------------------------|--------------------------------------|---|
| Trusted Source Error | Error | Offset limit violation of trusted source used -> Extended Options |
| Sync-E Input Quality Level Changed | Info | The quality factor of the SyncE reference has changed -> Option SyncE Configuration |
| Port Error | Error | E.g. short circuit at the input of an IMS-VSI reference card |
| Port Ok | Info | Signal at the port is OK (the card must support the port event - e.g. IMS-VSI). |
| Faillock: user banned | Action | Failed login - user is temporarily locked |

Table: All Notification Events

9.1.4 Security

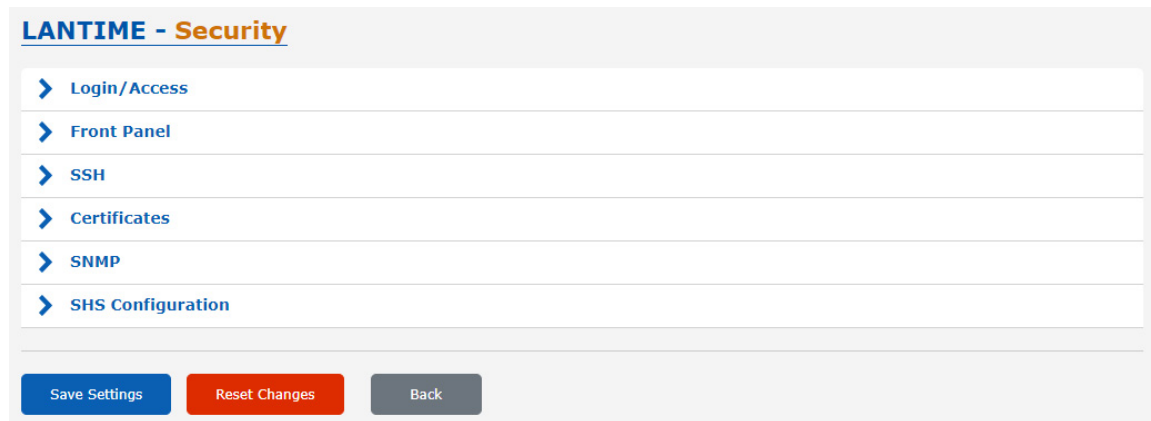

This page allows to configure access restrictions and snmp. It also provides the functionality to handle SSH keys and the HTTPS certificate.

If unsure of required values please contact the network security administrator and provide these parameters.

Login/Access

The "Login" menu allows you to set general security settings for the login behavior of the LANTIME.

Disable Root Login:

This function can only be activated by an admin user or by a super user. If this function is active, the "root" user can no longer log on to the LANTIME.

Remote Access Control:

In this configuration file, you can configure an access control for the LANTIME web interface based on the IP protocol. In this file, you can enter the IP addresses to be allowed to access the Web interface. After the first entry, access to all other clients is automatically blocked. Individual client IPs or entire subnets can be configured.

Shell Timeout:

Defines a timeout in seconds. After expiration of this period without any user interaction, the current session on the command line will be terminated for the logged-in user.

Web Timeout:

The parameter Web Timeout defines how many minutes of inactivity can pass before a user is automatically logged out of the Web interface.

Enable Bruteforce Detection:

When bruteforce detection is enabled, user accounts are temporarily locked after too many failed login attempts.

Unlock Time:

The unlock time, is the time until a locked user is unlocked again.

Number of Attempts:

The number of attempts, is the number of login attempts that must fail before a user account is locked.

Silent Mode:

Silent mode prevents the SSH interface from reporting a user's lock status. This also prevents the disclosure of valid user names to attackers, but reduces the traceability of users who have accidentally entered their login data incorrectly too often and cannot log in during the lockout period even with valid data.

Disable auto refresh on main page:

Prevents automatic reloading of the web interface in 60 seconds, as long as a user is in the main LANTIME web interface.

Front Panel:

Contains general security settings for the front panel of the LANTIME.

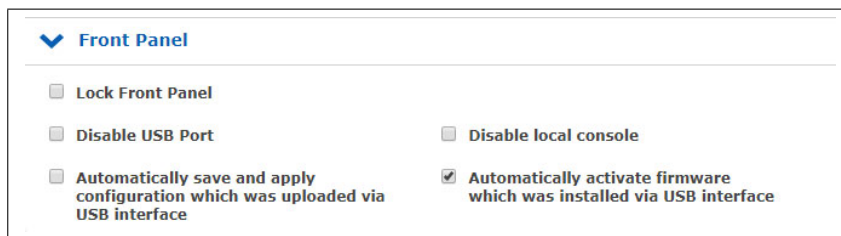
**Lock Front Panel:**

When the function is activated, the front panel of a LANTIME is disabled.

Disable USB Port:

After activating the feature, the USB port of a LANTIME at the front panel is deactivated and connected USB sticks can not be detected.

Checkbox "Automatically save and apply configuration which was uploaded via USB interface"

You can install a previously saved configuration on your LANTIME via the USB stick menu, if you have activated this check box, the uploaded configuration will be taken over directly as the start configuration.

Checkbox "Automatically activate firmware which was installed via USB interface"

By activating this checkbox, a firmware version loaded via the USB menu on the LANTIME will be directly taken over as active firmware.

Also see [USB Stick Menu](#).

9.1.4.1 SSH - Secure Shell

Via "Secure Shell Login" (SSH) it is possible to establish a secured connection to the LANTIME. All data is encrypted during the transmission over Ethernet. To use this service, SSH must be enabled on each interface in the network settings (read also the configuration chapter 9.1.2.3 "Web GUI → Network → Network Services").

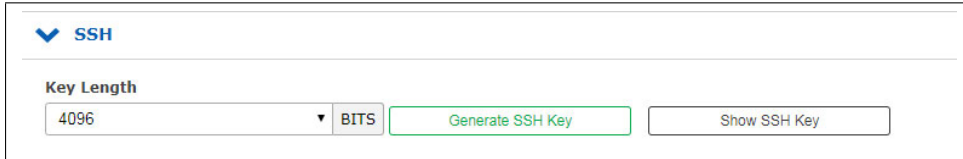

SSH

Key Length

4096 ▼ BITS

Generate SSH Key

Show SSH Key

Key Length (Bits):

Determines the key length for a new key to be generated.

Generate SSH Key:

Generates a key pair, consisting of a public and private key, in configurable length.

Show SSH Key:

You can use this button to display the public SSH keys of a LANTIME.

9.1.4.2 Certificates

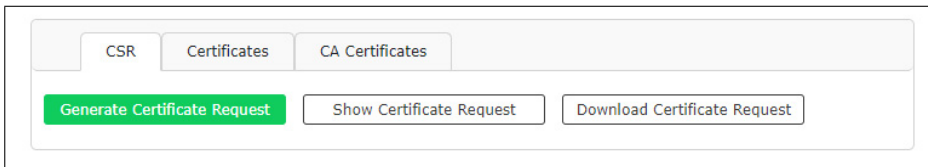

HTTPS is a standard for encrypted transmission of data between web browser and web server. It relies on X.509 certificates and asymmetric crypto procedures. The timeserver uses these certificates to authenticate itself to a client (web browser). The first time a web browser connects to the HTTPS web server of your LANTIME, you are asked to accept the certificate of the web server.

To make sure that you are talking to your known timeserver, check the certificate and accept it, if it matches the one stored on the LANTIME. All further connections are comparing the certificate with this one, which is saved in your web browser configuration. Afterwards you are prompted to verify the certificate only when it is changed.

Note: Per default there is a self-signed certificate installed on the LANTIME which is not signed by a Certificate Authority (CA). Therefore some web browsers will state that the connection is not secure. If you want to install a certificate which was signed by a trusted Certificate Authority the "Upload SSL Certificate" button can be used. More details on this in the following instructions.

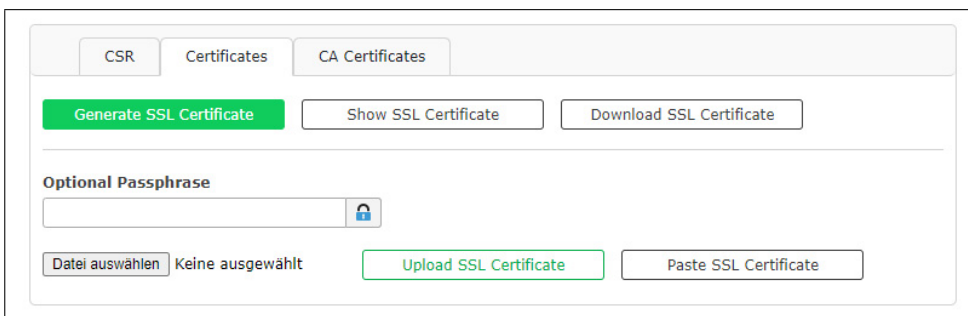

Generate SSL Certificate:

Allows to create a new self-signed SSL certificate.

Show SSL Certificate:

Review the currently installed SSL certificate.

Download SSL Certificate:

Allows to download the currently installed SSL certificate.

Optional Passphrase

If your private key uploaded with the certificate is protected with a passphrase, you must enter the "passphrase" here. Otherwise the webserver cannot start automatically because it cannot decrypt the uploaded private key.

Upload SSL Certificate:

Allows to upload a certificate which was signed by a trusted Certificate Authority. This certificate must be in PEM file format.

Generate Certificate Request:

This feature allows you to create a Certificate Signing Request (CSR) that can be sent to a Certificate Authority to request a signed certificate. This function creates a certificate and a private key on the LANTIME. The location for the CSR is `/mnt/flash/data/https.req`, the matching key is stored at `/mnt/flash/data/https.req.pk`.

Generate SSL Certificate

| | |
|--|---|
| Country Name (2 letter code) <input type="text" value="DE"/> | State or Province <input type="text" value="Some State"/> |
| Locality Name <input type="text" value="Some City"/> | |
| Organization Name <input type="text" value="Meinberg"/> | Organizational Unit <input type="text" value="Support"/> |
| Subject Alternative Name <input type="text" value="LT_DJ-29-105.local, LT_DJ-29-106.local"/> | Email Address <input type="text" value="info@meinberg.de"/> |
| Period of Validity <input type="text" value="3 Years"/> | |
| Key Length <input type="text" value="4096"/> | |

Please note: depending on the selected key length this could take several minutes.
Use the appropriate show button to prove that your certificate/CSR was created successfully

Subject Alternative Name

In the "Subject Alternative Name" field, you can specify additional host names (sites, IP addresses, common names, etc.) to be protected by a single SSL certificate, such as a multi-domain certificate. Multiple SANs must be entered as one comma-separated list.

Hint:

If you have generated the certificate submitted to the certification authority, via the function "Generate Certificate Request", the appropriate key for this certificate is already stored under `/mnt/flash/data/https.req.pk`. After uploading the signed certificate, this previously generated private key will be used.

If the submitted and signed certificate was not generated on the LANTIME, then the PEM file must contain the private key and the certificate itself.

The content of the private key starts with
"-----BEGIN RSA PRIVATE KEY-----"
and ends with
"-----END RSA PRIVATE KEY-----"

the certificate itself starts with
"-----BEGIN CERTIFICATE-----"
and ends with
"-----END CERTIFICATE-----".

This example is an excerpt from a PEM file:

```
-----BEGIN RSA PRIVATE KEY-----  
MIICXQIBAAKBgQC6FkGxyJ6+Bqxzfp3bNtEYyiRIAbQAIsHblYPG7aQk+8XbIXWB  
...  
aiLbmu7N3TEdWVDgro8kMuQC/Ugkttx7TdJJbqJoVsF5  
-----END RSA PRIVATE KEY-----  
-----BEGIN CERTIFICATE-----  
MIIEJTCCA46gAwIBAgIJANF4d1CI2saDMA0GCSqGSIb3DQEBBQUAMIG+MQswCQYD  
...  
ekZ970dAaPca  
-----END CERTIFICATE-----
```

9.1.4.3 CA Certificates

The functions in the menu "Security → certificates → CA certificates" can be used to add an own, non-public root certification authority to the LANTIME. This allows programs and services which establish a TLS connection, e.g. the LDAP service, to uniquely identify the requested server, even though no (mostly paid) certificate of a public certification authority is used.

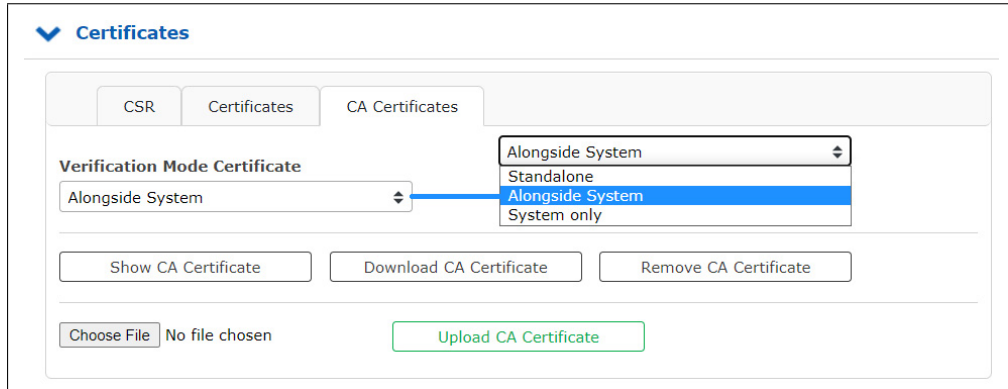

The Certificate Verification Mode can be selected as follows:

- Standalone:** The LANTIME uses only the uploaded own root certificate to verify connections.
- Alongside System:** The LANTIME uses the uploaded own root certificate and the system known public certification authority certificates.
- System only:** The LANTIME uses the system known public certification authority certificates.

9.1.4.4 Uploading Signed Multi-Level Certificates/Certificate Chains

Support is provided not only for SSL certificates but also multi-level certificates and certificate chains. Certificate chains can be uploaded together with the server certificate and private key in PEM format.

Certificate chains should be entered in the correct order to avoid potential problems. The first certificate must be the server certificate, followed by the intermediate certificates. The (optional) root certificate can be used to mark the end of the file. The key for the server certificate should be entered directly before or directly after the server certificate.

9.1.4.5 SNMP

The Simple Network Management Protocol (SNMP) is used in network management systems to monitor status of devices. SNMP works by querying "Objects". An object is simply something that we can gather information about a network device. The so called management information base (MIB) is a file which contains all objects that can be managed through SNMP.

The Meinberg SNMP MIB Files can be downloaded on the "System" page → Services and Functions → Download SNMP MIB". The files named "MBG-SNM P-ROOT-MIB.mib" and "MBG-LANTIME-NG-MIB.mib" need to be used to monitor a LANTIME system.

(see also configuration chapter "Web GUI → System → Services and Functions")

By default the SNMP service is not activated on a LANTIME system. The service can be activated on each interface at the "Network page → Network Services".

(see also configuration chapter "Web GUI → Network → Network Services")

The different SNMP configuration parameters are described below:

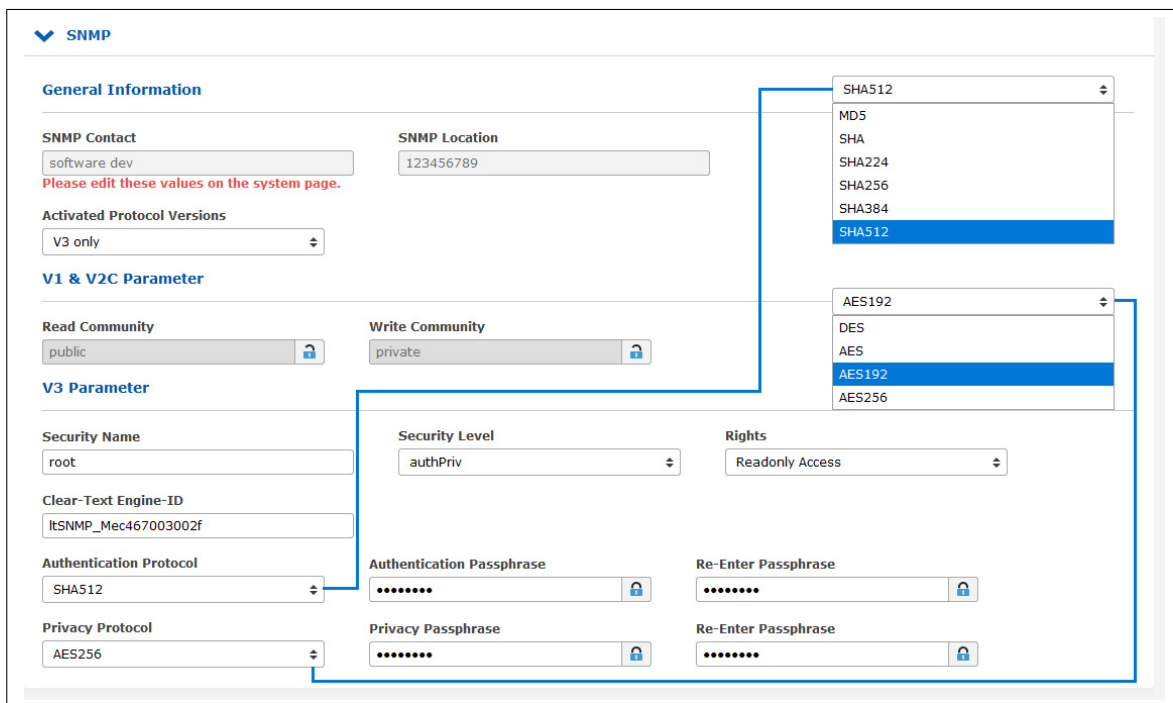

Activated Protocol Versions:

Configuration of the SNMP protocol version. The following options can be selected: "V1/V2 only", "V3 only", "V1/V2/V3".

V1/V2 Parameter**Read Community:**

The read community is only used for SNMP versions V1 and V2. It is like a user id or password that allows access to the LANTIME SNMP objects. The SNMP Monitoring system sends the read community string along with all SNMP requests. If the community string is correct, the LANTIME responds with the requested information. If the community string is incorrect, the LANTIME simply discards the request and does not respond.

Write Community:

The write community is only used for SNMP versions V1 and V2. It is like a user id or password that allows access to the LANTIME SNMP objects. The SNMP Monitoring system sends the write community string along with all SNMP-SET commands. If the community string is correct, the SNMP-SET command is executed. If the community string is incorrect, the SNMP-SET command is not executed.

V3 Parameter**Security Name:**

SNMP V3 User name

Security Level:

Messages can be sent unauthenticated, authenticated, or authenticated and encrypted by setting the Security Level to use:

noAuthnoPriv – unauthenticated and unencrypted

authNoPriv – authenticated and unencrypted

authPriv – authenticated and encrypted

Engine ID:

Within an administrative domain, a SNMP V3 Engine ID is a unique identifier of an SNMP engine. A string with a maximum of 27 characters can be entered here. The string is used to generate the hex engineID by using the text format scheme described in RFC3411. If for example the string "hello" is configured as engineID, the generated hex engineID would be 800015dd0468656c6c6f

- 15dd is the hexadecimal representation of the Meinberg enterprise ID 5597
- 04 is an indicator that the text format scheme is used to generate the engine ID
- 68656c6c6f is the hexadecimal representation of the string "hello"

| V3 Parameter | | |
|------------------------------------|---|--|
| Security Name | Security Level | Rights |
| <input type="text" value="root"/> | <input type="text" value="noAuthNoPriv"/> | <input type="text" value="Readonly Access"/> |
| Clear-Text Engine-ID | | |
| <input type="text" value="hello"/> | | |

Rights:

Configuration of the access level (Read access or Read/Write access).

Authentication Protocol:

The protocols used for Authentication are MD5 and SHA (Secure Hash Algorithm):

- MD5
- SHA
- SHA224
- SHA256
- SHA384
- SHA512

Authentication-Phrase:

User passphrase that must be at least 8 characters in length.

Privacy Protocol:

The protocols used for Encryption are DES (Data Encryption Standard) and AES (Advanced Encryption Standard):

- DES
- AES
- AES192
- AES256

Privacy Phrase:

A passphrase which is used when encrypting packets. It must be at least 8 characters in length.

9.1.4.6 SHS Configuration

SHS is the abbreviation for Secure Hybrid System and is available on LANTIME systems with two reference clocks. When the SHS mode is enabled only the currently active clock is used for passing the timing signal on to the NTP service, the other clock is indicated as "no select" and used only for measuring and comparing a time difference between both receivers.

In this respect SHS is different from a redundant mode. In redundant mode a switching unit switches between one or the other clock, depending on its availability and sync status and the active clock passes the timing signal on the NTP service.

SHS mode takes care for a secure operation and it steps into action when a time difference between both receivers exceeds a configurable time limit.

When this happens the alarms will be triggered and send out via configured notification channels (e.g SNMP trap, email, syslog message). Besides, the NTP should be stopped in this case too to support the secure operation of the timing service, therefore you have to select "Stop NTP Service on Time Limit Error" at this step.

On the other hand, in IMS Systems with two reference clocks the timing signal coming from the clocks is continuously measured with a RSC card (Redundant Switch Control unit) and compared against each other. The measurements are forwarded to the SHS mode if this is enabled. Similar as in LANTIME systems with SHS, the alarms can be triggered when a difference of the two signals exceeds the configured time limit settings and the NTP service should be configured to stop.

The screenshot shows the SHS Configuration page with the following settings:

- SHS-Mode:** Enabled
- Time Limit Warning Level:** 10000000 ns
- Time Limit Critical Level:** 100000000 ns
- Stop NTP Service on Time Limit Error

SHS-Mode

The SHS mode can be selectively enabled or disabled via this selection box. If the SHS mode is disabled, no time comparison takes place and the times of both receivers are transferred directly to the NTP service. The NTP service then decides autonomously which time is used for synchronization (redundant mode).

Time Limit Warning Level

If the calculated time difference between the two reference clocks exceeds the configured value, the LANTIME generates a "SHS Time Limit Warning" alarm. This alarm can be sent via e-mail or SNMP Trap, if it is configured correspondingly in the Notification settings.

(see also configuration chapter "Web GUI → Notification → [Email Information](#)")

In LANTIME IMS systems with a built-in RSC, the parameter is configured in nanoseconds. For systems without an RSC in milliseconds.

Time Limit Error Level (ms)

If the calculated time difference between the two reference clocks exceeds the configured value, the LANTIME generates a "SHS Time Limit Warning" alarm. This alarm can be sent via e-mail or SNMP Trap, if it is configured correspondingly in the Notification settings.

In LANTIME IMS systems with a built-in RSC, the parameter is configured in nanoseconds. For systems without an RSC in milliseconds.

Stop NTP Service on Time Limit Error

Here you can decide if the NTP service is to be terminated at the Critical "TimeLimitError". In this case, requesting NTP clients would no longer receive a response from the time server.

9.1.5 NTP

LANTIME - NTP

- General Settings
- External NTP Server
- Broadcast Settings
- NTP Multicast & Manycast
- Autokey Settings
- NTP Symmetric Keys
- NTP Configuration
- NTP Restrictions
- NTP Leap Second Handling
- Special Settings

Save Settings
Reset Changes
Back

The NTP configuration page is used to set up the additional NTP parameters needed for a more specific configuration of the NTP subsystem.

9.1.5.1 General Settings

▼ General Settings

Stratum Level When Unsynchronized

Disable Stratum Change

NTP Trusttime MRS

Local Trusted Keys

Enable Autokey

Stratum Level when Unsynchronized

The stratum value for NTP refers to a distance away from a reference source and not the accuracy. For example, a time server with an internal reference such as GPS or DCF77, internally has a Stratum 0 and is considered from an external network as Stratum 1. The setting "Stratum Level when Unsynchronized" is used to configure the stratum value, by which the server presents itself in the network, when a reference time source is not available. This value does not take an effect until the configured NTP Trusttime for the internal reference clock has expired and no further time sources such as external NTP servers are available.

Disable Stratum Changes

By activating this operation mode, the server always presents itself (even if asynchronous) as a Stratum 1 server in the network. The "Stratum Level When Unsynchronized" setting will become ineffective.

Examples:

- a) A LANTIME, which is synchronized by its internal reference clock such as GPS or DCF77, acts as a Stratum 1 NTP server. If the "Disable Stratum Change" function is activated, the NTP server will act as Stratum 1 server, if the reference clock goes asynchronous and no other time sources are available.
- b) A LANTIME, which is only synchronized by an external NTP server with Stratum 3, acts in a network as Stratum 4 NTP server. If the "Disable Stratum Change" function is activated, the NTP server will still act as Stratum 4 NTP server, even if the connection to the external NTP server is lost.
- c) If NTP of the LANTIME with activated "Disable Stratum Change" function, changes from its internal reference clock to an external NTP server with Stratum 2, the Stratum of the LANTIME will change from 1 to 3.

NTP Trusttime

This setting defines for how long NTP should "trust" the internal reference clock of a server after this has become asynchronous. The status of an asynchronous reference clock is also called "free running". The accuracy of a "free running" reference clock depends on the type of the integrated oscillator. The trust time should therefore be set dependent on the accuracy of the "free running" reference clock.

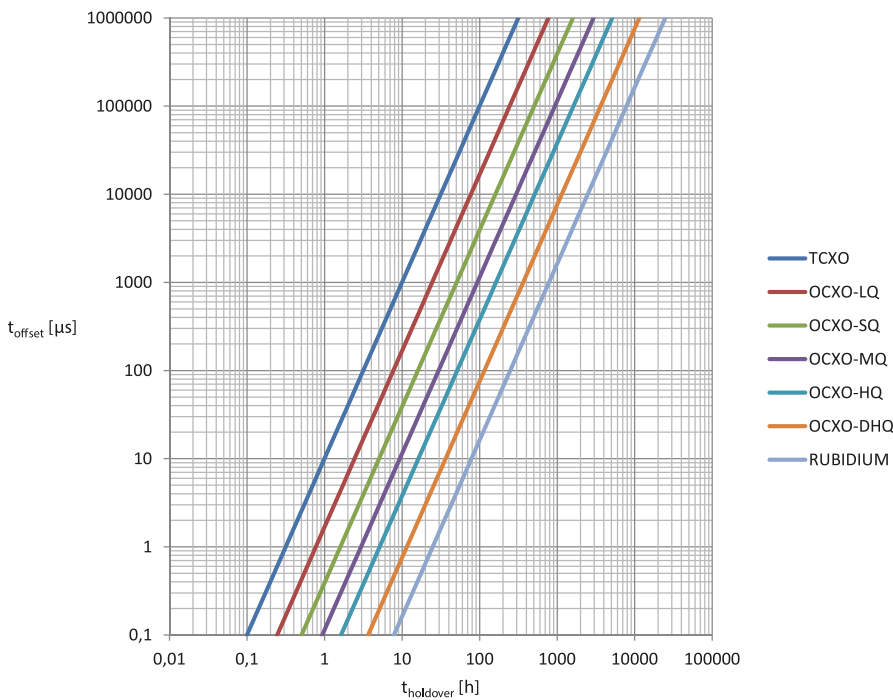

Figure: relation between holdover time (x) and offset (y) by using of built-in Meinberg oscillators

How do I configure the correct Trusttime in my application environment?

As an example, we now assume that our receiver has a built-in TCXO oscillator. The Trusttime should run out from an offset of 1ms. The graphic shows that this offset is reached after 10 hours of holdover time. Therefore a Trusttime of 10 hours should be configured.

Procedure: First you should find out which oscillator is used. Go to the web interface menu "Monitoring and Management → Clock → Receiver Information → Oscillator Type". Then you can define an offset, from which the NTP should lose its stratum or the trust time.

A list of oscillators available for Meinberg reference clocks:
<https://www.meinbergglobal.com/english/specs/gpsopt.htm>

Local Trusted Keys

In this field, you can enter the IDs of the symmetric keys which shall be used for the authentication. If you have more than one key, the IDs need to be entered with a space to separate them from one another. You can configure the symmetric keys in the submenu "NTP Symmetric Keys" on the NTP page. See "NTP Symmetric Keys" sub chapter for more information.

9.1.5.2 External NTP Server

Via the configuration page you can enter up to 10 external NTP server as backup for the internal reference clock.

Server Address:

IP or Hostname of an external Server.

Symmetric Keys:

In this optional field, you can enter the ID of a symmetric key, which is to be used for authentication with the external server.

The following must be considered, to make the authentication work:

- a) The NTP key file of the server must contain the ID. You can edit the key file in the submenu "NTP → NTP Symmetric Keys" on the NTP page.
- b) Additionally you must enter the ID into the field "Local Trusted Keys" under "NTP → General Settings".
- c) The same key with the same ID must be configured on the external server.

Minpoll and Maxpoll (not supported on devices which support the MRS feature):

With these settings, you can set the minimum and maximum polling interval (query cycle) for a given external server. NTP starts with the minimum polling interval and changes step by step to the maximum of the polling interval.

Use Iburst (not supported on devices which support the MRS feature):

The iburst activation accelerates the initial synchronization with an external server.

Use NTS (only available on devices that support the MRS function)

This option activates Network Time Security for the respective external NTP server. If NTS is activated, no further authentication procedure can be used for this server. The configuration of symmetric keys or autokey is thus ignored for this server.

For NTS authentication to work, the following points must be taken into account:

- The server address entered must correspond to that of the NTS-KE server.
- To be able to verify the NTS-KE server, a corresponding root certificate must be available on the LANTIME (see CA Certificates).

Particularity LANTIME/MRS:

All external NTP servers are requested for statistical purposes only and are never directly selected as synchronisation peers by the time service. Normal NTPv4 servers are added as "noselect" in the NTPD configuration file */etc/ntp.conf* for this purpose.

Since NTPD currently does not support Network Time Security, external NTS servers are requested via a separate Chrony time service.

The LANTIME MRS logic then selects the best server among all servers. The selection algorithm for the best external NTP server is separated in the following steps:

- select which server is accepted
- create groups of different offsets
- select the biggest group
- check for outliers and remove them from that group
- use the median as best-server
- check if `last_best_external_NTP_server` can be used -
to reduce clock hopping

The best server can be checked in the Web Interface under "Statistics → NTP Status" and under "Clock → Status & Configuration → MRS Status". The determined offset is then used to discipline the internal oscillator in case no other reference source with a higher priority is available.

Due to this particularity, the configuration possibilities for external NTP server are different. The parameters `Minpoll`, `Maxpoll` and `lburst` cannot be configured on a LANTIME/MRS.

For a LANTIME/MRS you can adjust the default polling interval of 32 seconds via the manual configuration of the server. To proceed follow this menu navigation:

Web Interface - "System Page → Services and Functions → Manual Configuration → Standard Configuration → Miscellaneous Configuration"

LANTIME - System

Sonstige-Einstellungen manuell bearbeiten:

```
[GENERAL CONFIGURATION]
RDT SERIAL REF TYPE=2
RDT DISABLE SERIAL INTERFACE=NO
PANEL LIGHT PERMANENT ON=NO
FAN MODE=0
FAN TEMP THRESHOLD=55
MRS MODE=0
MRS NTP POLL INTERVAL=0
MRS NUM NTP PACKETS PER POLL=0
RESTRICT NTP ACCESS WHILE INIT=NO
GLOBAL UTC OFFSET=0
ACTIVATE CHANGES PERMANENT=NO
NTP CLIENT COUNTER ENABLED=YES
NTP CLIENT COUNTER RUNTIME=0
NTP CLIENT COUNTER LOG LEVEL=0
```

You can use the parameter "MRS NTP POLL INTERVAL" to adjust the polling interval of the external server. As per default this value is set to 0, which means that external are queried every 32 seconds. Values can be set between 1 and 10 and are used as a power of 2. For example if this value is set to 6, this is equal to $2_6 = 64$ seconds for a polling interval.

Use the parameter „MRS NUM NTP PACKETS PER POLL“ to set the number of NTP queries sent per polling interval. Per default this value is set to 0, which means that 4 packets are sent in a given polling interval. Set a value between 1 and 8, which corresponds to the actual number of packets.

9.1.5.3 Broadcast Settings

▼ Broadcast Settings

| | | |
|--------------------------------------|-----------------------------------|----------------------|
| Broadcast Address 1 | Broadcast Interval | Symmetric Key |
| <input type="text"/> | <input type="text" value="Auto"/> | <input type="text"/> |
| <input type="checkbox"/> Use Autokey | | |

| | | |
|--------------------------------------|-----------------------------------|----------------------|
| Broadcast Address 2 | Broadcast Interval | Symmetric Key |
| <input type="text"/> | <input type="text" value="Auto"/> | <input type="text"/> |
| <input type="checkbox"/> Use Autokey | | |

If the NTP time should be distributed in Broadcast mode in a local network, you can enter a valid broadcast address into this menu. Please note: starting with NTP4 version, the broadcast mode must always be used with authentication.

Broadcast Address:

A valid broadcast address of a local network, to which the LANTIME is connected must be entered here.

Broadcast Interval:

The interval at which the server sends the NTP packets to the configured broadcast address.

Symmetric Keys:

In this field you can enter the ID of a symmetric key, which is to be used for authentication with the NTP clients.

The following must be respected, to make the authentication work:

- a) The NTP key file of the server must contain the ID. You can edit the key file in the submenu "NTP → NTP Symmetric Keys" on the NTP page.
- b) Additionally you must enter the ID into the field "Trustable Keys" under "NTP → General Settings".
- c) The same key with the same ID must be configured on the NTP client.

The following is an excerpt from the NTP configuration of a client, which is configured as a broadcast client with authentication:

```
keys /etc/ntp.key # Path to the NTP Key File
trustedkey 1 # The Key ID, which is used for the authentication
broadcastclient # This client works as a broadcast client
```

9.1.5.4 NTP Multicast and Manycast

▼ NTP Multicast & Manycast

Enable Multicast

Multicast Address
Broadcast Interval
TTL

Symmetric Key
 Use Autokey

Enable Manycast

Manycast Address
Symmetric Key
 Use Autokey

9.1.5.5 NTP Multicast

NTP Multicast offers the possibility to distribute the time by multicast in the network. The Internet Assigned Numbers Authority (IANA) has exclusively allocated the multicast IP address 224.0.1.1 for NTP. Therefore, it is recommended to use this address as a multicast address. However, also other addresses of the multicast address space can be set.

The multicast address space is as follows:

```
Ipv4: 224.0.0.0 -> 239.255.255.255
Ipv6: Every FF00::/8 Address
```

Multicast Address: A correct multicast address must be entered here.

Broadcast Interval: The interval at which the server sends the NTP packets to the configured broadcast address.

TTL: The configured TimeToLive (TTL) value determines how many hops NTP packets can pass in the network. Each network hop reduces this value by 1. When the value reaches zero, the network packet is dropped.

Symmetric Keys: For NTP Multicast, an authentication is recommended, but not mandatory. However, if the authentication is configured on the server side, it is also necessary to do so on the client side.

In the field "Symmetric Keys" you can therefore enter the ID of a symmetric key, which is to be used for authentication with the NTP clients.

The following must be respected, to make the authentication work:

- a) The NTP key file of the server must contain the ID. You can edit the key file in the submenu "NTP → NTP Symmetric Keys" on the NTP page.
- b) Additionally you must enter the ID into the field "Trustable Keys" under "NTP → General Settings".
- c) The same key with the same ID must be configured on the NTP client.

The following is an excerpt from the NTP configuration of a client, which is configured as a multicast client with authentication:

```
keys /etc/ntp.key           # Path to the NPT Key file
trustedkey 1                # The Key ID, which is used for the authentication
multicastclient 224.0.1.1 key 1 # The Client listens on the Multicast Address 224.0.1.1 and
                                # uses the key with ID 1 for authentication
```

9.1.5.6 NTP Manycast

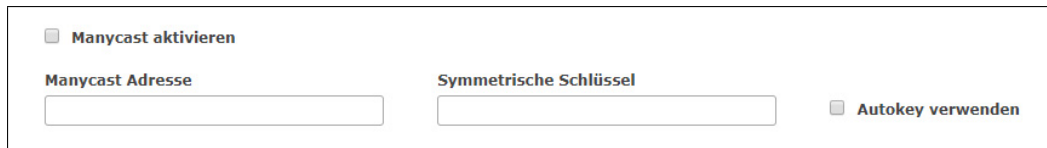

NTP Manycast describes the possibility that one or more NTP servers are behind a multicast address. However, contrary to the multicast method, the servers do not send NTP packets periodically to this multicast IP. The Manycast feature is much more a method to automatically reconfigure the NTP service of a requesting client. The NTP service of the client selects up to 3 servers automatically, which seem to be "best" for him. The NTP service then reconfigures itself independently, and establishes a unicast communication with these servers. As with multicasting, it is recommended to use authentication methods.

Enable Manycast: It activates the Manycast-Feature

Manycast Address: Address field for entering the manycast address (multicast address space)

The Multicast Address Range is as follows:

```
Ipv4: 224.0.0.0 -> 239.255.255.255
Ipv6: Every FF00::/8 Address
```

Symmetric Keys: For NTP Manycast, a key method for authentication is recommended, but not mandatory. However, if the authentication method is configured on the server side, it is necessary to do so on the client side.

In the field "Symmetric Keys" you can therefore enter the ID of a symmetric key, which is to be used for authentication with the NTP clients.

The following must be respected, to make the authentication work:

- The NTP key file of the server must contain the ID. You can edit the key file in the submenu "NTP → NTP Symmetric Keys" on the NTP page.
- Additionally you must enter the ID into the field "Trustable Keys" under "NTP → General Settings".
- The same key with the same ID must be configured on the NTP client.

The following is an excerpt from the NTP configuration of a client, which is configured as a multicast client with authentication:

```
keys /etc/ntp.key           # Path to the NPT Key file
trustedkey 1                # The Key ID, which is used for the authentication
manycastclient 224.0.1.2 key 1 # The Client listens on the Multicast Address 224.0.1.2 and
                               # uses the key with ID 1 for authentication
```

9.1.5.7 NTP Autokey Settings

NTP Version 4 supports symmetric keys and additionally provides the so-called AUTOKEY feature. The authentic of received time at the NTP clients is sufficiently ensured by the symmetric key technique. In order to achieve a higher security, e.g. against so-called replay attacks, it is important to change the used crypto keys from time to time.

The screenshot shows a web interface for NTP Autokey Settings. At the top, there is a dropdown menu labeled 'Autokey Settings'. Below it, there are three buttons: 'Generate NTP Autokey Certificate' (highlighted in green), 'Generate Groupkey', and 'Download Groupkey'. Underneath these buttons is a file upload section with a 'Choose File' button and the text 'No file chosen', followed by an 'Upload Groupkey' button. At the bottom, there is a password field labeled 'NTP Autokey Password' with a lock icon to its right.

In networks with a lot of clients, this can lead to a logistic problem, because the server key has to be changed on every single client. To help the administrator to reduce this work (or even eliminate it completely), the NTP developers invented the AUTOKEY feature, which works with a combination of group keys and public keys. All NTP clients are able to verify the authentic of the time they received from the NTP servers of their own AUTOKEY group by using this AUTOKEY technique.

The AUTOKEY features works by creating so-called secure groups, in which NTP servers and clients are combined. There are three different kinds of members in such a group:

a) Trusted Host

One or more trusted NTP servers. In order to become a “trusted” server, a NTP server must own a self-signed certificate marked as “trusted”. It is good practice to operate the trusted hosts of a secure group at the lowest stratum level (of this group).

b) Host

One or more NTP servers, which do not own a “trusted” certificate, but only a self-signed certificate without this “trusted” mark.

c) Client

One or more NTP client systems, which in contrast to the above mentioned servers do not provide accurate time to other systems in the secure group. They only receive time.

All members of this group (trusted hosts, hosts and clients) have to have the same group key. This group key is generated by a so-called trusted authority (TA) and has to be deployed manually to all members of the group by secure means (e.g. with the UNIX SCP command). The role of a TA can be fulfilled by one of the trusted hosts of the group, but an external TA can be used, too.

The used public keys can be periodically re-created (there are menu functions for this available in the web interface and also in the CLI setup program, see “Generate NTP Autokey Certificate” in section “NTP Autokey Settings” of the “Security Management” page) and then distributed automatically to all members of the secure group. The group key remains unchanged, therefore the manual update process for crypto keys for the secure group is eliminated.

A LANTIME can be a trusted authority / trusted host combination and also a “non-trusted” host in such a secure group.

To configure the LANTIME as a TA / trusted host, enable the AUTOKEY feature and initialise the group key via the HTTPS web interface (“Generate groupkey”) or CLI setup program. In order to create such a group key, a crypto password has to be used in order to encrypt / decrypt the certificate. This crypto password is shared between all group members and can be entered in the web interface and CLI setup program, too. After generating the group key, you have to distribute it to all members of your secure group (and setup these systems to use AUTOKEY, too). In the ntp.conf file of all group members you have to add the following lines (or change them, if they are already included):

```
crypto pw cryptosecret  
keydir /etc/ntp/
```

In the above example “cryptosecret” is the crypto password, that has been used to create the group key and the public key. Please note that the crypto password is included as a plain text password in the ntp.conf, therefore this file should not be world-readable (only root should have read access to it).

On the clients, the server entries must be altered to enable the AUTOKEY feature for the connections to the NTP servers of the group. This looks like:

```
server time.meinberg.de autokey version 4  
server time2.meinberg.de
```

You find the server time.meinberg.de which is using the AUTOKEY feature, while time2.meinberg.de is used without any authentic checks.

If you want to setup the LANTIME server as a trusted host, but need to use a different trusted authority, please create your own group key with this TA and include it with the web interface of your LANTIME (on page “Security Management” see section “NTP autokey” , function “Upload groupkey”).

If you want to setup the LANTIME as a “non-trusted” NTP server, you have to upload the group key of your secure group (“Security Management” / “NTP autokey” / “Upload groupkey”) and create your own, self-signed certificate (without marking it as “trusted”). Because every certificate which is creating by using the web interface and/or CLI setup is marked “trusted”, you have to execute the tool “ntp-keygen” manually on your LANTIME by using shell access (via SSH).

```
LantimeGpsV4:/etc/ntp # ntp-keygen -q cryptosecret
```

Here, too, “cryptosecret” is the crypto password used in the ntp.conf entry. Then you have to copy the new ntpkeys to the flash disk with:

```
cp /etc/ntp/ntpkey_* /mnt/flash/config/ntp/uploaded_groupkeys
```

A detailed description about ntp-keygen can be found on the NTP website (<http://www.ntp.org>).

Example:

This autokey group is formed by one Stratum-1-server (B), two Stratum-2-servers (D and E) and a number of clients (in the diagram there are 4 clients shown, c1 – c4). B is the trusted host, he holds the group key and a self-signed certificate marked as “trusted”.

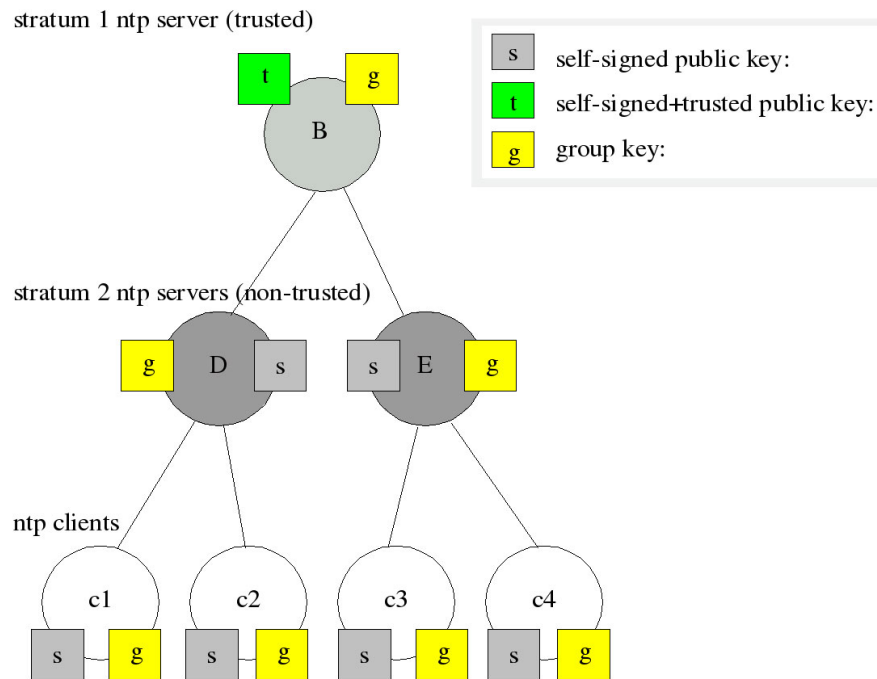

D and E are NTP servers, which are “non-trusted” hosts of the group, they hold the group key and a self-signed certificate which lacks the “trusted” mark. The clients also hold the group key and a self-signed certificate. In order to distribute new public keys to the whole group, the administrator only has to generate a new “t” key, which will be distributed automatically to the two hosts D and E. Because these two servers can now present a unbroken chain of certificates to a trusted host, they can be considered “trusted” by the clients as well.

More about the technical background and detailed processes of the AUTOKEY technique can be found at the official NTP website (<http://www.ntp.org>).

9.1.5.8 NTP Symmetric Keys

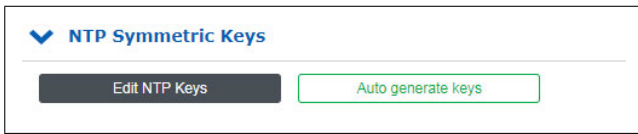

Since NTP version 3, NTP has been providing an authentication method using symmetric keys. The "NTP Edit Key" button can be used to edit the NTP key file of the server. Upon delivery of the server, the file contains a sample key. The "Automatically Generate Keys" button allows keys to be generated automatically.

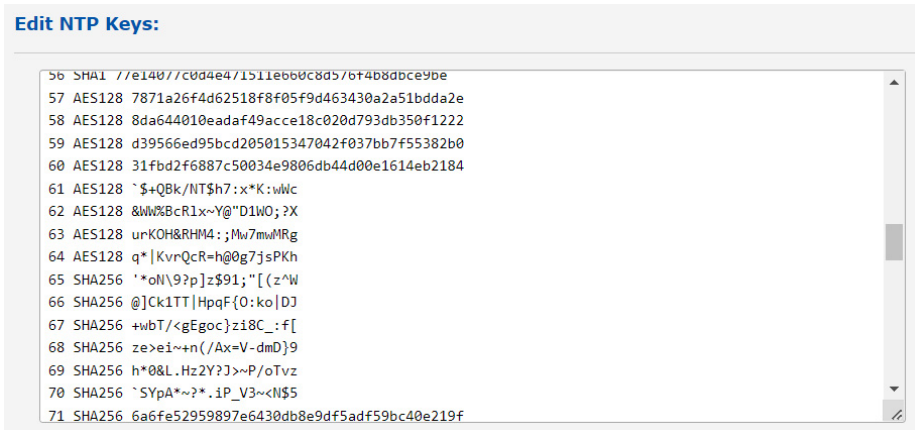

Figure: Menu "NTP → NTP Symmetric Keys → Edit NTP Keys"

Attention:

If symmetric keys are already in use and should be kept, the contents of this file must be cached before a new block is automatically generated. The contents of the "old" file must then be re-inserted into the field **Edit NTP Keys** together with the "new" keys.

The following is an representative excerpt from an NTP key file:

| | | | |
|---|------------|--|-------------------|
| 1 | MD5 | BtdW/<gj2*2M;!'-qAIN | # MD5 Key |
| 2 | SHA1 | 094c533b614d9e4bcb6e18a97a7b0e4d459025bd | # SHA1 Key |
| 3 | SHA256 | bb48079a17b370fb0ae48bc1a09d5e0ab1ce59fc | # SHA256 Key |
| 4 | SHA512 | 56b98e4d4f57d415bebbb1a0ff72c625a57d865c | # SHA512 Key |
| 5 | AES128CMAC | 02eb9a63710dda360d181d9582056a504d965700 | # AES128-CMAC Key |

The first column contains a unique key ID (value range 1 - 65535). The second column contains the key type ("MD5" for an MD5 key, "SHA1" for a SHA1 key, AES128CMAC for a AES128-CMAC key etc.). The third column contains the key string, which may be between 1 and 40 characters long.

How do I set up authentication between a LANTIME and my NTP clients?

1. Add the keys which are to be used to the key file of the server as shown in the excerpt of an NTP key file.
2. Enter the IDs of these keys into the "Trusted Keys" field under "NTP → General Settings", for example:

Local Trusted Keys

3. The following is a sample excerpt from the NTP configuration of a Linux client which uses the key with the ID 2 for authentication with the server 192.168.100.1 and the key with the ID 3 for authentication with the server 192.168.100.2:

```
keys /etc/ntp.keys # path to keys file
trustedkey 2 3 # IDs of keys to be trusted

server 192.168.100.1 iburst minpoll 6 maxpoll 6 key 2
server 192.168.100.2 iburst minpoll 6 maxpoll 6 key 3
```

In this case, the key file of the client must contain the keys with the IDs 2 and 3, which must be identical to the keys of the server.

9.1.5.9 NTP Configuration

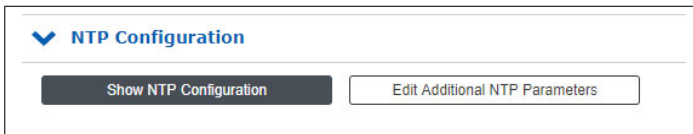

The current NTP configuration file is displayed via the "Show current NTP configuration" button. This file is automatically generated by the system at every restart or change of the NTP configuration and cannot be edited directly.

If additional settings are required for NTP (Authentication, Restriction ...), which are not covered with the existing settings on the NTP page, an additional configuration file must be used. This file can be edited and managed using the "Edit Additional NTP Parameters" button. Every time the 'ntp.conf' is created this additional file is automatically attached to it.

9.1.5.10 NTP Restrictions



The "NTP Restrictions" page can be used to restrict NTP access to specific IP addresses.

For example, to allow access for all addresses from the subnet 192.168.100.x, enter 192.168.100.0 under IP Address and 255.255.255.0 under Netmask. Access can also be allowed for individual IP addresses.

In order to enable the restricted access, the "Activate Access Restriction" option must be activated here. Client IP addresses, which are not covered in the allowed IP address ranges, will no more receive NTP responses from the LANTIME.

Ignore NTP Mode 6 and 7 Packets

This setting cause that internal information, like Access statistics, cannot be queried by other NTP able devices in the network, via the NTP service of the server. The setting does not have any effect on the time synchronization between NTP clients and the server.

Activate access restriction

By activating this setting the following lines will be written into the NTP configuration of the Server:

```
restrict default noserve
restrict -6 default noserve
restrict 127.0.0.1
restrict -6 ::1
```

These settings cause that the server no longer responds to NTP requests. In the submenu "Configure NTP Restrictions" you can configure a "white list" of client IP addresses or even entire subnets whose requests are allowed to be answered by the server.

9.1.5.11 NTP Leap Second Handling

The time base for mostly all the world's local time zones is called Coordinated Universal Time, UTC, which is derived from a several atomic clocks which are distributed in different countries all over the world. The rotation of the earth is not constant and varies over time, while the mean earth rotation speed is decreasing slowly. This is the reason why so called leap seconds are inserted into the UTC time scale, which compensate the UTC time with the real earth rotation. A leap second is always inserted at 23:59:59 (UTC), either on 31.12. or 30.06. (Other dates are theoretically possible, but practically have not been used yet).

Some protocols or methods for transferring the time information, e.g. GPS, NTP, PTP, DCF77 and IRIG can pre-announce leap seconds to give a receiver the opportunity to prepare for a leap second in advance. The GPS satellite system distributes the leap second announcement six months before the leap second event. Meinberg LANTIMEs with GPS receivers receive this announcement automatically via the GPS signal. In the log file of the LANTIME, the entry "Leap Second Announced" is generated when the date of the leap second is received.

Other synchronization methods do not offer this announcement possibility, which can lead to a one second time jump. Therefore, it is necessary to keep the NTP leap second file up-to-date on these systems, so that a leap second is correctly inserted at the midnight (UTC).

In the menu "NTP Leap Second Handling", you can view the currently stored leap second file, you can manually upload the file or configure an automatic download from the following source pages:

Available Download Sources for Leap Second Files:

1. NIST Leap Second File:
<ftp://time.nist.gov/pub/> (directory listing)
<ftp://time.nist.gov/pub/leap-seconds.list> (current leap second file)
2. IERS (Earth Rotation and reference systems Service) Leap Second File:
<https://hpiers.obspm.fr/iers/bul/bulc/ntp/> (directory listing)
<https://hpiers.obspm.fr/iers/bul/bulc/ntp/leap-seconds.list> (current leapseconds file)
3. Meinberg Leap Second File (Copy of the IERS Leap Second File):
<https://www.meinberg.de/download/ntp/leap-seconds.list>
https://www.meinberg.de/download/ntp/leap_second

9.1.5.12 Special Settings

Special Settings

Time Scale: UTC

Fixed Offset: 0 Seconds

Max. Internal Offset: 0 ms

Pass-through MRS Stratum

Time Scale

This setting configures the time zone of the NTP. The default setting is "UTC", since NTP is based on UTC by default and standard NTP clients expect UTC time.

The setting "LOCAL TIME" should only be selected, if the time server is used to synchronize specific clients that require local time. If you select "LOCAL TIME" here, the exact time zone must be configured in the menu "System → Display".

Attention: The use of "LOCAL TIME" is a violation of the NTP standard and causes standard NTP clients to accept faulty time and to make a time jump accordingly.

Fixed Offset (s)

This value is used to manipulate the output time of the NTP service. The configured value in seconds is added to the current time and provides a possibility to spoof the NTP time if wanted.

Attention: The use of a "Fixed Offset" is a violation of the NTP standard and causes standard NTP clients to accept faulty time and to make a time jump accordingly.

Max. Internal Offset (s)

This value in milliseconds specifies a minimum accuracy the NTP service must reach, before the server starts to serve time to the clients. E.g. entering a value of 1ms means that the service will wait until the internal clock has reached 1ms accuracy or better.

Pass-through MRS Stratum

This feature only comes into effect if you synchronize a LANTIME with MRS feature primarily via NTP. If "Pass-through MRS Stratum" is not activated, the LANTIME presents itself as Stratum 1 server in the network. If "Pass-through MRS Stratum" is active, the stratum of the external NTP server is considered. For example, if the external server is a Stratum 1 server, the MRS LANTIME would appear as Stratum 2 server in the network.

9.1.6 PTP

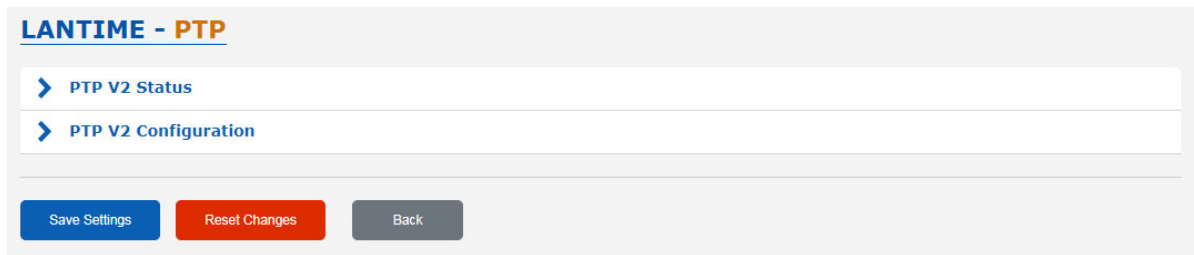

All parameters for proper PTP functionality can be configured in a clear and user friendly Web GUI. The set of parameters which can be configured in the Web GUI corresponds to the PTP card version currently installed in the system. Some features are available with TSU-GbE cards and above only and these are marked as optional (*) in this manual.

When you log in to the Web GUI, please follow to the PTP dialog. In the main menu the following sub-menus are listed:

- PTP Status
- PTP Configuration

If more than one PTP unit (PTP ports) is built into the system, then the status and configuration for each port can be edited separately and will be listed on this page.

9.1.6.1 PTP Status Information

The PTPv2 status dialogue shows all current status information of the selected PTP card according to its settings configured in the configuration submenu.

9.1.6.2 PTP Network Status

In the Network tab you can check if network settings of the PTP card are valid.

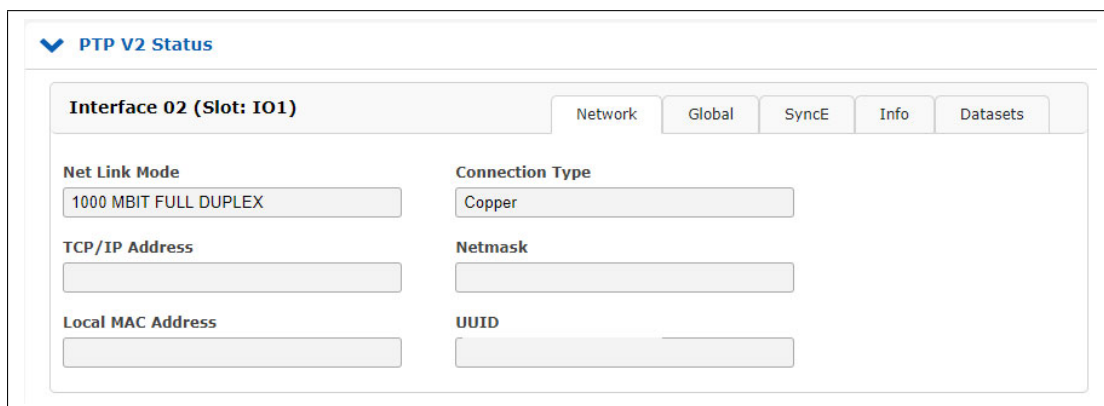

Local MAC Address of the PTP unit

If the PTP card operates currently as a Grandmaster (GM) its local MAC Address is shown in the status of PTP slaves which are currently synchronized to this GM.

UUID

The UUID is the unique identifier of the PTP port which is based on the MAC address of the PTP port.

9.1.6.3 PTP Global Status

In the Global submenu the current operation mode of the selected PTP port (interface) is shown. The appearance of this page depends on the mode of the PTP card operation. Different states of a PTP port are possible. For example, if the unit is configured as a PTP master clock, then this page shows "Master" state. In MRS (Multi Reference Source) devices, the PTP mode "Slave" may be displayed here.

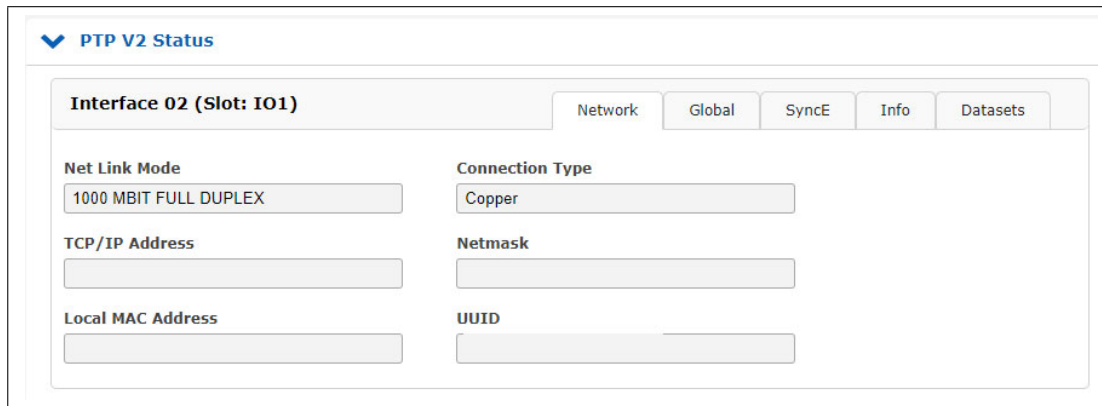

Port States

| | |
|------------------------|--|
| Uninitialized | The PTP module is booting up, the software daemon has not yet started, the IP address is not yet assigned. |
| Initializing | In this state the port initializes its data sets, hardware, and communication facilities. |
| Faulty | Not defined in LANTIME systems. |
| Stopped | The PTP service has been stopped or it has not started due to a missing link on the PTP port or a not-synchronized master clock after a startup. |
| Disabled | Not defined in LANTIME systems. |
| Listening | The port is waiting for the announceReceiptTimeout to expire or to receive an Announce message from a master. |
| preMaster | A short transitional state while the port is becoming a master. |
| Master | The port is a current master. |
| Passive | The port is in passive mode, meaning there is another master clock active in the PTP domain. The port can enter master state when it wins the BMCA (Best Master Clock Algorithm) due to a failure/service degradation of the current master. |
| Uncalibrated | The port wants to become a slave in the PTP domain and has already detected a suitable grandmaster. The TSU is waiting to calculate the path delay to a Grandmaster. |
| Slave | The port has successfully subscribed to a master and receives all expected messages. It also successfully measured the path delay using delay request messages. |
| Grandmaster MAC | The MAC Address of the current Grandmaster. |

| | |
|------------------------|--|
| Clock Accuracy | The clock accuracy of the active grandmaster. This value is used in the Best Master Clock Algorithm to select the best master. |
| PTP Seconds | Current value of the raw PTP seconds value (seconds since 1970). |
| UTC Offset | This value represent the current Offset to the PTP time based on TAI to calculate UTC. |
| Domain Number | A PTP domain is a logical group of PTP devices within a physical network which is defined by the same domain number. Slave devices that should sync to a certain master in the network must be configured with a unique domain number which is the same as for the master. |
| Port Link up | Status 0: the port is down, check the link LED and the connection to the link partner. If faulty, the network card should be replaced. Status 1: the port is in normal operation. |
| Delay Asymmetry | If a static asymmetry offset in the network is known, this value may be entered (in ns) to compensate it before the PTP start. |
| Clock Class | PTP Clock class of the currently selected PTP grandmaster. This value is used in the Best Master Clock Algorithm. |
| Time Source | The type of a time source as used by the Grandmaster (informative only). |
| Leap Second | Leap second announcement flag, set up to 24 hours prior the leap second event, depending on the GM implementation. |
| TSU Time | Displayed time of day in the selected PTP timescale. |

9.1.6.4 SyncE Status

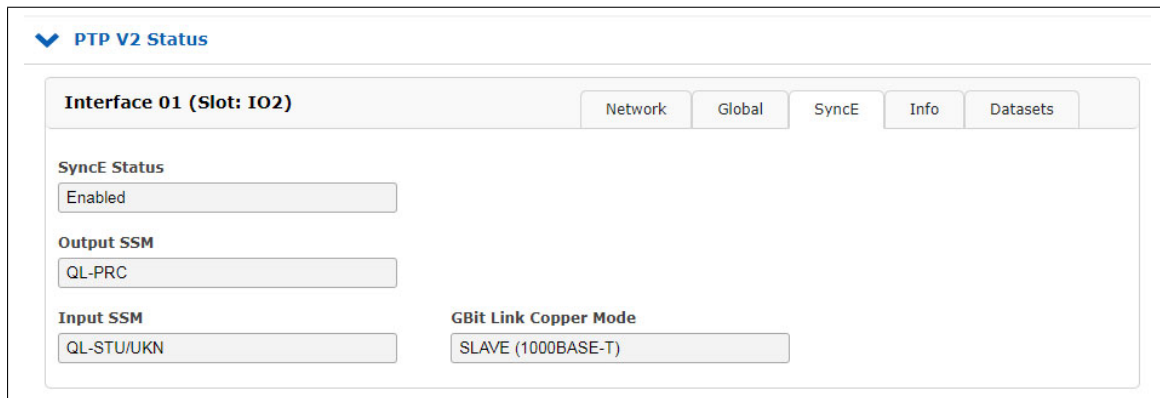

You can check if SyncE functionality is activated on the card or not (if supported by the PTP module).

9.1.6.5 Menu PTP Status Info

▼ PTP V2 Status

Interface 01 (Slot: IO2) Network Global SyncE Info Datasets

Info

| | |
|-----------------|--|
| ID | HPS5 Cyclone5 High Performance Sync Module HPS100 1.4.1 2018-10-08 License (8/1024) |
| S/N | 007411036570 |
| Kernel Version | Linux hps100 4.0.0 #1 SMP Wed Nov 14 09:05:56 CET model name : ARMv7 Processor rev 0 (v7l) |
| eth1 | HWaddr EC:46:70:00:CF:F1 |
| CPU Information | |
| FPGA Version | 511h |
| PTP Stack | 1.4.1 (GIT 1.3-101mbg) |

Packet Counter

| | |
|-----------------|-------------|
| Announce Msg RX | 37331 (0/s) |
| Announce Msg TX | 0 (0/s) |
| Sync Msg RX | 74642 (1/s) |
| Sync Msg TX | 0 (0/s) |
| FollowUp Msg RX | 0 (0/s) |
| FollowUp Msg TX | 0 (0/s) |
| DelayReq Msg RX | 0 (0/s) |
| DelayReq Msg TX | 37398 (0/s) |

| # | IP | AnnRate | SyncRate | DlyRspRate | Last Req. |
|---|----|---------|----------|------------|-----------|
| Currently no active unicast connections | | | | | |

Under this menu item you will find information about the used PTP module, about the packets sent and received (Packet Counter) as well as information about active unicast connections.

9.1.6.6 Menu PTP Status Datasets

Interface 01 (Slot: MRI1) Network Global SyncE Info Datasets

Current Dataset

| | |
|---------------------|-----|
| Steps Removed | 0 |
| Offset From Master: | 0ns |
| Mean Path Delay | 0ns |

Parent Dataset

| | |
|-----------------------------|---------------------------|
| Port Identity | ec-46-70-ff-fe-00-bd-67:0 |
| Parent Stats: | 0 |
| Grandmaster Priority 1: | 128 |
| Grandmaster Priority 2 | 128 |
| Grandmaster Clock Class | 6 |
| Grandmaster Clock Accuracy: | < 100 ns |
| Grandmaster Clock Variance | 13563 |

p->default_dataset.clock_quality.clock_accuracy: 33 < 32
3

Default Dataset

| | |
|-------------------|-------------------------|
| Number PTP Ports: | 1 |
| Two Step | No |
| Slave Only | No |
| Priority 1 | 128 |
| Priority 2 | 128 |
| Clock Class | 6 |
| Clock Accuracy: | < 100 ns |
| Clock Variance | 13563 |
| Clock Identity | ec-46-70-ff-fe-00-bd-67 |
| Domain Number | 0 |

Time Properties Dataset

| | |
|----------------------|-----|
| Current UTC Offset: | 37s |
| Leap 61 | No |
| Leap 59: | No |
| UTC Offset Valid | Yes |
| PTP Timescale: | Yes |
| Time Traceable | Yes |
| Frequency Traceable: | Yes |
| Time Source: | GPS |

Port Dataset

| | |
|-------------------------------------|---------------------------|
| Port Identity | ec-46-70-ff-fe-00-bd-67:0 |
| Port State | Master |
| Minimum Delay Req. Interval | 1 every 2 second |
| Peer Mean Path Delay | 0ns |
| Announce Interval | 1 every 2 second |
| Announce Receipt Timeout | 3s |
| Sync Interval | 1 per second |
| Delay Mechanism | E2E |
| Minimum Peer Delay Request Interval | 1 per second |
| Version Number | 2 |

Clock Variance:

This a log scaled statistic which represents the jitter and wander of the clocks oscillator over a Sync message interval.

9.1.6.7 PTP Configuration Menu

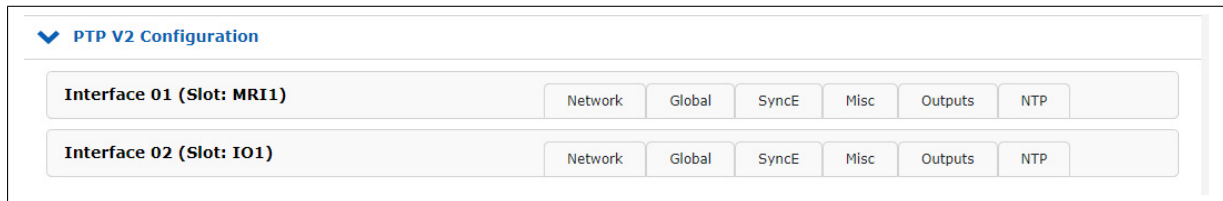

All parameters for proper operation of each PTP port (interface) which are built into the system should be configured separately according to its function in the PTP network. Whenever a change should be applied, it needs to be saved by confirming the “Save Settings” button at the bottom of the page.

The configuration parameters are grouped in the submenus as follows. Submenus marked with * are available on HPS100 or TSU-GbE modules only (the tabs marked with ** only on HPS100).

- Network
- Global
- SyncE*
- Misc*
- Outputs*
- NTP** (Software NTP Service)

9.1.6.8 PTP Network Configuration

PTP V2 Configuration

Interface 01 (Slot: IO2) Network Global SyncE Misc Outputs NTP

Monitor Interface

Net Link Mode
Autoneg

Hostname **Domainname**
PTPv2

Nameserver 1 **Nameserver 2**
0.0.0.0 0.0.0.0

Enable DHCP-Client
Yes

IP-Address from DHCP **Netmask from DHCP** **Gateway from DHCP**
172.27.100.229 255.255.0.0 0.0.0.0

TCP/IP Address **Netmask** **Default Gateway**
192.168.100.10 255.255.255.0 192.168.100.1

IPv6 Mode **IPv6 Address**
Static 2001:db8:a0b:12f0::1/64

IPv6 Multicast Scope
FF01 - Interface-Local Scope

Enable VLAN Option

VLAN-Tag (0-4094) **Priority**
0 0

DSCP PTP Classification
CUSTOM 00 (HEX: 00)

Multicast TTL
5

Monitor Interface

Monitoring of network port's link status. As soon as the selected PTP network connection no longer detects a link, this state triggers a "PTP Link Down" event. This event is displayed in the menu "Notification → Notification Events".

If the PTP module is not required and is therefore not connected to the network, the checkbox "Monitor Interface " can be unchecked. No error event will be triggered then.

| | |
|--------------------------------|--|
| NET Link Mode | Selectable values are: Autonegotiation 100 MBIT HALF DUPLEX 100 MBIT FULL DUPLEX 1000 MBIT HALF DUPLEX 1000 MBIT FULL DUPLEX |
| Hostname | Hostname, a unique alphanumeric label, which distinguishes the selected PTP port from others in the network can be entered here. |
| Domainname | Domainname for the selected PTP can be assigned. |
| Nameserver1 | Nameserver1 can be entered if it is used in a network. |
| Nameserver2 | Nameserver2 can be entered if it is used in a network. |
| Enable DHCP-Client | Activation / deactivation of DHCP service. If a DHCP Client is activated the field for static IP configuration is deactivated. The opposite is the case when DHCP Client is deactivated. |
| IP-Address from DHCP | If DHCP service is found in the network, a valid IP for a PTP port will be assigned automatically and displayed here. |
| Netmask from DHCP | If DHCP service is found in the network, a valid Netmask for a PTP port will be assigned automatically. |
| Gateway from DHCP | If DHCP service is found in the network, a valid Gateway for a PTP port will be assigned automatically. |
| TCP / IP Address | If the DHCP Client is deactivated, this field can be edited to assign a valid static IP address for the selected PTP interface. |
| Netmask | If the DHCP Client is deactivated, this field can be edited to assign a netmask for the selected PTP interface. |
| Default Gateway | If the DHCP Client is deactivated, this field can be edited to assign a default gateway for the selected PTP interface. |
| IPv6 Mode | IPv6 addressing via DHCPv6 / Static assignment / Router Advertisement are available. |
| IPv6 Address | Ipv6 Address assigned to the selected PTP port. If Static option is activated for Ipv6 Mode, then a valid static IP address can be configured in this field. |
| IPv6 Multicast Scope | The prefix of IPv6 multicast addresses specifies their scope. A specific scope in case of multicast mode can be selected here. |
| Enable VLAN Option | Activation / deactivation of Virtual LAN (IEEE 802.1Q) service on the PTP interface. |
| VLAN-Tag (1-4094) | A 12-bit value specifying a VLAN ID to which a PTP port belongs. |
| Priority | Values 0 (default, lowest priority) to 7 (highest priority) which can be used to prioritize network traffic for different types of data. |
| Disable SSH Service | If checked then SSH Access for this PTP port is deactivated. This option is only available with a TSU-GbE module. |
| DCSP PTP Classification | Differentiated Services Code Point. This is a QoS parameter within the IP header of the Classification PTP packet to prioritize the traffic. |

Multicast TTL

Time-To-Live. By default, the PTP multicast traffic is not routed and this value is defined as "1" by the PTP standard. However a user defined configuration of the TTLvalue can be entered here to change the default value.

9.1.6.9 PTP Global Configuration

PTP V2 Configuration

Interface 02 (Slot: IO1) Network Global SyncE Misc Outputs NTP

Operating Mode
 Disabled PTP V2 PTP V1 NTP Monitor

Select Profile
 Custom

PTP Mode
 Multicast Slave Hybrid-Mode

Unicast Master Address 1 **Unicast Master Address 2**
 0.0.0.0

Delay Mechanism **Domain Number**
 E2E 0

Network Protocol
 UDP/IPv4 (L3)

Timescale **Priority1**
 PTP Standard (TAI) 128

Priority2
 128

Announce Interval **Sync Interval**
 1 announce message every 2 seconds 1 sync message per second

Delay Request Interval
 1 request message every 2 seconds

Interval Duration [s] **Announce Receipt Timeout**
 60 3

Alternate Time Offset Indicator
 No

Profile Specific Configuration

| | |
|-------------------------|-------------------------------------|
| Power IEEE C37.238-2011 | Use Profile Extensions No |
| Telecom ITU-T G.8265.1 | Grandmaster ID 3 |
| Telecom ITU-T G.8275.1 | Network Inaccuracy 0 ns |
| SMPTE ST 2059-2 | |
| IEEE 802.1AS | |
| Utility IEC 61850-9-3 | |
| Power IEEE C37.238-2017 | |

Operating Mode

PTP or NTP

If supported, it is possible to run an NTP service in server mode with hardware timestamp support. In this step, choose between PTP and NTP mode. It is not possible to run both modes simultaneously on one TSU card.

PTPv2 or PTPv1 (HPS100 - license PL-C/D/E)

The card can operate in PTPv1 mode to serve as a communication interface between PTPv1 and PTPv2 network elements.

Monitor (HPS100 - license PL-D/E)

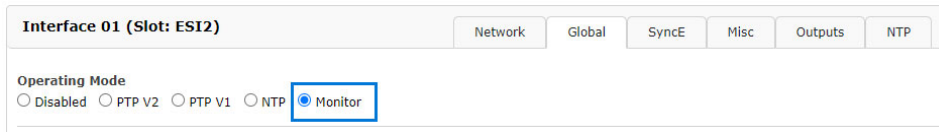

Interface 01 (Slot: ES12)

Network Global SyncE Misc Outputs NTP

Operating Mode

Disabled PTP V2 PTP V1 NTP Monitor

To monitor PTP network elements and generate statistics, a HPS100 can operate in monitor mode. Only if this mode is activated, it is possible to monitor PTP-nodes in the network via the HPS100.

Select Profile

User can choose among preselected sets of PTP parameters defined in profiles usually used in different industries. If the default setting "Custom" is selected, the user can select any parameter combination available in the global configuration section as long as the PTP standard allows it. Depending on the selected profile, there might be profile specific parameters available which can be found in the "Profile Specific Parameters" section below the standard PTP parameters sections.

There are twelve different presets currently supported on PTP cards:

Please note: When you switch to another profile, your current settings are overwritten with the default values of the selected profile.

Example: When selecting the Telecom ITU-T G.8275.1 profile, SyncE is automatically activated and the GBit Link Copper mode in the the tab **SyncE** is set to "Automatic".

Auf 172.27.29.105 wird Folgendes angezeigt:

Do you want to set the preset values? Your current settings will be replaced by the default values for the selected preset.

Ok

Abbrechen

In Unicast Master / Slave Mode:

Telecom ITU-T G.8265.1

- Ann Msg Rate: 1/sec
- Sync Msg Rate: 16/sec
- Del Req Rate: 16/sec
- Priority 1: 128
- Priority 2: 128
- Delay Mech: "E2E"
- Network Prot: "Layer 3 (UDP/IPv4,v6)"

Telecom ITU-T G.8275.2

- Ann Msg Rate: 8/sec
- Sync Msg Rate: 128/sec
- Del Req Rate: 128/sec
- Priority 1: 128
- Priority 2: 128
- Delay Mech: "E2E"
- Network Prot: "Layer 3 (UDP/IPv4,v6)"

In Unicast or Multicast Master / Slave Mode:

Default E2E IEEE 1588-2008

Default Profile with End-To-End Delay Mechanism as defined by the IEEE 1588-2008 standard, available in Multicast and Unicast mode.

- Ann Msg Rate: 2/sec
- Sync Msg Rate: 1/sec
- Del Req Rate: 1/sec
- Priority 1: 128
- Priority 2: 128
- Delay Mech: "E2E"
- Network Prot: "Layer 3 (UDP/IPv4,v6)"

SMPTE ST 2059-2

- Ann Msg Rate: 4/sec
- Sync Msg Rate: 8/sec
- Del Req Rate: 8/sec
- Priority 1: 128
- Priority 2: 128
- Delay Mech: "E2E" or "P2P"
- Network Prot: "Layer 3 (UDP/IPv4,v6) or Layer 2 (IEEE 802.3)"

AES67 Media Profile

- Ann Msg Rate: 1/sec
- Sync Msg Rate: 8/sec
- Del Req Rate: 8/sec
- Priority 1: 128
- Priority 2: 128
- Delay Mech: "E2E" or "P2P"
- Network Prot: "Layer 3 (UDP/IPv4)"

In Multicast Master / Slave Mode:

Default P2P IEEE 1588-2008

Default Profile with P2P delay mechanism as defined by the IEEE 1588-2008 standard, available in Multicast mode.

- Ann Msg Rate: 2 sec
- Sync Msg Rate: 1/sec
- Del Req Rate: 1/sec
- Priority 1: 128
- Priority 2: 128
- Delay Mech: "P2P"
- Network Prot: "Layer 3 (UDP/IPv4,v6) or Layer 2 (IEEE 802.3)"

Telecom ITU-T G.8275.1

- Ann Msg Rate: 8/sec
- Sync Msg Rate: 16/sec
- Del Req Rate: 16/sec
- Priority 1: 128
- Priority 2: 128
- Delay Mech: "E2E"
- Network Prot: "Layer 2 (IEEE 802.3)"

Power IEEE C37.238-2011

- Ann Msg Rate: 1/sec
- Sync Msg Rate: 1/sec
- Del Req Rate: 1/sec
- Priority 1: 128
- Priority 2: 128
- Delay Mech: "P2P"
- Network Prot: "Layer 2 (IEEE 802.3)"
- VLAN (802.1Q): enabled (VLAN ID:0, Prio:4)
- Power Profile: TLVs enabled

Power IEEE C37.238-2017

- Ann Msg Rate: 1/sec
- Sync Msg Rate: 1/sec
- Del Req Rate: 1/sec
- Priority 1: 128
- Priority 2: 128
- Delay Mech: "P2P or E2E"
- Network Prot: "Layer 3 (UDP/IPv4,v6) or Layer 2 (IEEE 802.3)"
- Power Profile: TLVs enabled

Utility IEC 61850-9-3

- Ann Msg Rate: 1/sec
- Sync Msg Rate: 1/sec
- Del Req Rate: 1/sec
- Priority 1: 128
- Priority 2: 128
- Delay Mech: "P2P"
- Network Prot: "Layer 2 (IEEE 802.3)"
- Power Profile: TLVs enabled

IEEE 802.1AS

- Ann Msg Rate: 1/sec
- Sync Msg Rate: 8/sec
- Del Req Rate: 1/sec
- Priority 1: 248
- Priority 2: 248
- Delay Mech: "P2P"
- Network Prot: "Layer 2 (IEEE 802.3)"

DOCSIS 3.1

- Ann Msg Rate: 8/sec
- Sync Msg Rate: 16/sec
- Del Req Rate: 16/sec
- Priority 1: 128
- Priority 2: 128
- Delay Mech: "E2E"
- Network Prot: "Layer 2 (IEEE 802.3)"

PTP Mode:

A PTP port can operate in one mode only: master or slave. When the mode is selected the user can choose between multicast or unicast-only protocol. In the newest firmware a combined unicast multicast master mode of operation is also supported.

Hybrid-Mode:

In this mode PTP messages Sync, FollowUp and Announce are sent in Multicast whereas the DelayRequest and DelayResponse Messages are sent in Unicast.

Delay Mechanism:

Two options possible:

E2E (End-to-end) where delay measurement messages are sent directly from a slave to the master (two end nodes).

P2P (Peer-to-peer): each device (a peer) in the network exchanges peer-delay measurement messages. This way each node can keep a track of the delays between itself and its immediately connected neighbour. P2P mechanism can be used in 1588 PTP-capable networks only.

Domain Number:

A PTP domain is a logical group of PTP devices within a physical network which is defined by the same domain number. Slave devices that should sync to a certain master in the network must be configured with a unique domain number which is the same as for the master.

Network Protocol:

Three options for network protocol are possible:

ETH-IEEE 802.3 / Ethernet (Layer 2): Ethernet frames including MAC addresses of a slave and master.

UDP/IPV4 or UDP/IPV6 (Layer 3): User Data Protocol one of the main protocols used for the Internet.

Timescale:

Two options are possible:

PTP: As per default TAI timescale is used in PTP timing. TAI is a linear timescale without discontinuities such as inserted leap seconds in the UTC timescale. A time unit is based on SI second. The TAI timescale started with 1 January 1970 00:00:00.

Arbitrary:

If "Arbitrary" is selected, the time sent over PTP will be UTC and not TAI. Consequently, the timestamps in the PTP messages will also be based on UTC instead of TAI. Also, the UTC_OFFSET field in the announce messages will be changed from 37 (current number of leap seconds as of 12/2021) to 0.

Priority 1:

The attribute is used in the execution of the best master clock algorithm (BMCA). Lower values take precedence. Configurable range: 0..255. The operation of the BMCA selects clocks from a set with a lower value of priority1 over clocks from a set with a greater value of priority1.

Priority 2:

The attribute is used in the execution of the BMCA. Lower values take precedence.

Configurable range: 0..255.

In the event that the operation of the BMCA fails to order the clocks based on the values of priority1, clockClass, clockAccuracy and scaledOffsetLogVariance, the priority2 attribute allows the creation of up to 256 priorities to be evaluated before the tiebreaker. The tiebreaker is based on the clockIdentity. The values clockClass, clockAccuracy and scaledOffsetLogVariance depend on the internal state of the grandmaster and cannot be configured.

Msg. Intervals:

Specify the settings for PTP message rates.

Announce Interval:

Specifies the rate for sending announce messages between masters in order to select the current Grand Master. Available settings are: 16/s, 8/s, 4/s ... 2s, 4s, 8s, 16s with a default value 2 seconds.

Sync Interval:

Specifies the rate for sending sync messages from a master to slave.

Available settings are: 128/s, 64/s ... 64s,128s, with a default value 1 second.

Delay Request Interval

Specifies the rate how often delay request messages are sent from a slave to the master. Delay request messages intervals 128/s, 64/s ... 64s, 128s, with a default value 2 seconds.

Interval Duration [s]:

Requested duration until timeout / renewal.

Announce Receipt Timeout:

Specifies the rate for announce receipt timeout messages which is generally 2-10 times the Announce Interval rate, with a default value of 3. In this time the BMCA procedure should select the current Grandmaster.

Alternate Time Offset Indicator Extension:

The Alternate Time Offset Indicator (ATOI) TLV extension is used to transmit local time information, such as local time zone offset and summer time changeover, from master to slave devices. This TLV has a current offset data field and can therefore provide the data required to convert TAI- or UTC-based time information to local time.

Profile specific Settings

Only if the custom profile has been selected can this option be used. It is possible here to select profile-specific parameters simply for your own "custom profile". To do this, the "Use Profile Extensions" select field must first be set to **Yes**.

Grandmaster ID

In Power Profile C37.238-2011, a 1-byte ID must be assigned to the Grandmaster. Choose an ID between 3 and 254.

9.1.6.10 Option SyncE Configuration

The screenshot shows the 'PTP V2 Configuration' page for 'Interface 01 (Slot: IO2)'. It features several tabs: Network, Global, SyncE (selected), Misc, Outputs, and NTP. The 'SyncE' tab is active, displaying the following settings:

- Enable SyncE
- Quality Level Selection: Enabled
- SDH Network Option: SDH Network Opt. 1
- Fixed Input SSM: QL-PRC
- Fixed Output SSM: QL-DNU
- Minimum SSM: QL-STU/UKN
- Local Priority: 0
- Gbit Link Copper Mode: Manually
- Mode: Force Prefer
- Port: Master Slave

This submenu allows all relevant settings for the Synchronous Ethernet functionality. SyncE is an ITU-T standard for computer networking that facilitates the transference of clock signals over the Ethernet physical layer.

Note:

The SyncE signal can only be used as a reference input signal, when a TSU-GbE card operates in an MRI Slot (see menu - "Configuration Receiver → MRS Settings").

Enable SyncE

Activation / Deactivation if SyncE signal on a PTP port. SyncE runs on the PHY network layer therefore it does not disturb PTP on Layer 2 or Layer 3. They both can run in parallel on the same port.

Quality Level Selection

If enabled, the Quality Level is transported once per second within the ESMC (Ethernet Synchronization Message channel) and are determined automatically depending on the clock status in master mode or used as they are received as an input in slave mode. If this mode is disabled, then the settings chosen below in Fixed Input SSM and Fixed Output SSM are used permanently as static values.

SDH Network Option

The selected values for the Quality levels depend on the SDH network options which reflect to Option 1 (for SDH, E1 based systems) or Option 2 (for SONET, T1 based systems).

Fixed Input SSM Fixed Quality level of the SyncE input signal.

Fixed Output SSM Fixed Quality level of the SyncE output signal.

Gbit Link Copper Mode

If the copper mode is used for SyncE in Gbit mode then the Clock Master or Clock Slave needs to be defined. This is not necessary if optical connections via SFP are used as this is determined automatically there.

Mode

User can select if the copper port should be forced to act as the clock master or clock slave depending on the role (Master/Slave) that this SyncE port should have. Missconfiguration can lead to link loss, so the user needs to take care about the proper configuration of the link partners.

Port

The port can operate in a SyncE clock master or clock slave mode. A configuration is only necessary for the copper port but not for Fibre Optic connections.

9.1.6.11 Misc. Configuration

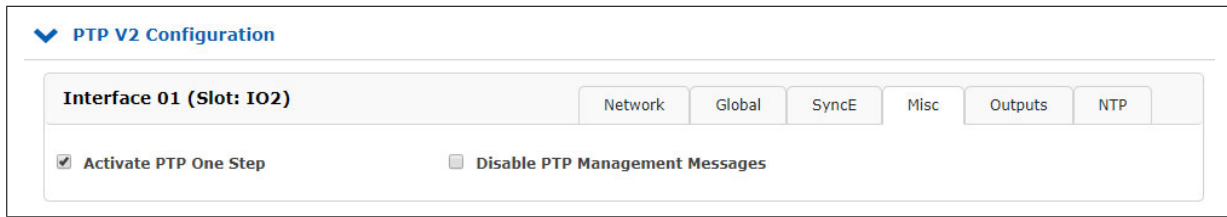

PTP V2 Configuration

Interface 01 (Slot: IO2)

Network Global SyncE Misc Outputs NTP

Activate PTP One Step Disable PTP Management Messages

Activate PTP One Step:

Per default Two Step approach is active.

Two Step approach: The PTP protocol requires the master to periodically send SYNC messages to slave devices. The hardware time stamping approach of PTP requires that the master records the exact time when such a SYNC packet is going on the network wire and needs to communicate this time stamp to the slaves. This can be achieved by sending this time stamp in a separate packet (a so-called FOLLOW-UP message).

One Step operation enabled: the SYNC messages itself is time stamped on- the- fly just before it leaves the network port. Therefore, not FOLLOW-UP message is needed.

Disable PTP Management Messages

A protocol within PTP use to query and update the PTP data sets maintained by master clocks. These messages are also used to customize a PTP system and for initialization and fault management. Management messages are used between management nodes and clocks. This feature is enabled per default.

9.1.6.12 Option: Output Configuration

PTP V2 Configuration

Interface 01 (Slot: IO2) Network Global SyncE Misc Outputs NTP

Output 1
10 MHz (REF, main oscillator) ▼

Output 2
10 MHz (REF, main oscillator) ▼
Off
PPS (HPS local)
10MHz (HPS local)
2048 kHz (REF, main oscillator)
10 MHz (REF, main oscillator) (highlighted)
PPS (REF, main oscillator)

SyncE Misc Outputs

TSU-GbE card comprises one Gigabit Ethernet SFP/RJ45 Combo Port for network synchronization and two female BNC output interfaces with a list of available signals as follows:

- PPS (generated locally on the TSU)
- 10 MHz (generated locally on the TSU)
- 2048 kHz (taken from active internal clock module)
- 10 MHz (taken from active internal clock module)
- PPS (taken from active internal clock module)

Per default no output signal is active on both outputs.

9.1.6.13 Configuration NTP

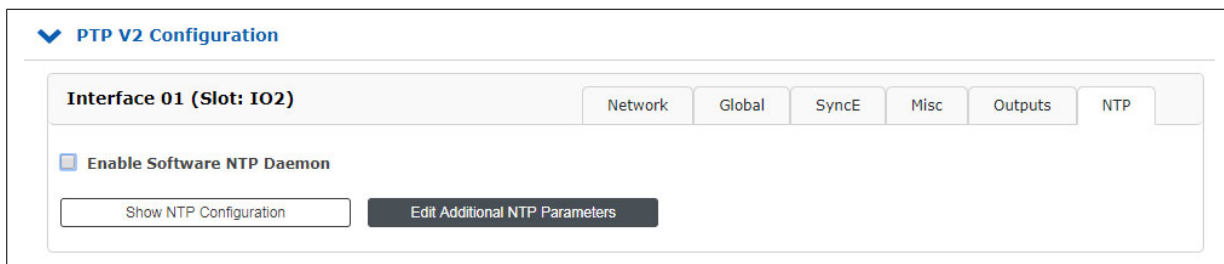

Software NTP Daemon

This feature is only supported by PTP modules of type HPS100 with HPS firmware version $\geq 1.4.1$. The type and firmware version of a built-in PTP module can be checked under "PTP → PTPv2 Status → Info".

Enable Software NTP Daemon:

If activated, a Software NTP Daemon "*ntpd*" is also started on the PTP module. This service works in the same way as the NTP software service on the LAN-CPU and can be parameterized accordingly. The Software NTP Daemon can be used in parallel with all other operating modes of the PTP module that can be set in the "Global" tab. Symmetric keys configured on the main system under "NTP → NTP Symmetric Keys" are automatically included in the NTP configuration of the PTP module. If the PTP module has been configured as an NTP server in the "Global" tab, all NTP requests without symmetric key authentication will continue to be answered by the hardware NTP responder of the PTP module. NTP requests with symmetric key authentication are answered by the Software NTP Daemon.

Display NTP configuration:

This button can be used to display the current NTP configuration. The initial configuration is generated automatically when the Software NTP Daemon is activated.

Editing Additional NTP Parameters:

This button can be used to configure additional NTP parameters, such as Restrictions or Trusted Keys. The syntax must follow the standard configuration syntax of the *ntpd*. After saving, configured lines are automatically appended to the NTP configuration generated by the PTP module.

9.1.6.14 PTP Dual Stack Mode

Starting with HPS100 firmware version 2.0.3 with PL-C as the minimum performance level, two independent PTP instances per port can be configured. The LANTIME firmware 7.04 supports the configuration of these two PTP instances and can display the status of the two PTP instances separately.

For example on one PTP card, two PTP Grandmaster instances can be started for both IPv4 and IPv6 mode or for Layer 2 and Layer 3 operation in parallel.

If a PTP slave instance is configured then a second instance is not possible. More constraints on possible configuration options can be found below.

Performance Notes

There are different client capacities available between the two PTP instances. The first instance (Instance 1) has the full capacity of PTP clients or DelayRequests per second as the Performance Level grade allows (ie: 256 unicast clients with PL-B).

However, the second PTP instance that is running in parallel to the first one has the CPU power as the limiting factor. The total capacity of the PTP packet engine is approx. 15.000 PTP transactions per second.

Webinterface: PTP → Status → Global

In case the feature is provided by the HPS card, the Web UI shows the status of the two PTP instances on two independent tabs on the Network, Global, Info and Datasets page:

The screenshot displays the 'PTP V2 State' web interface. At the top, there is a navigation bar with tabs for 'Network', 'Global', 'SyncE', 'Info', and 'Datasets'. Below this, the 'PTP Instances' section is active, showing 'Instance 1' selected. The interface lists various configuration parameters and their current values:

- PTP Mode:** Unicast Master
- Domain Number:** 0
- Port State:** Master
- Port Link up:** Yes
- Grandmaster MAC:** EC:46:70:00:BF:9C
- GM Clock Accuracy:** < 100 ns
- GM Clock Class:** 6
- PTP Seconds:** 1627894446
- Time Source:** GPS
- UTC Offset:** 37s
- Leapsecond:** Not Announced
- Time Traceable:** Yes
- Frequency Traceable:** Yes
- TSU Time:** TAI:02.08.21 08:54:06.000000;

Webinterface: PTP → Status → Info

The PTP Packet Counter for both instances can be shown independently.

▼ PTP V2 State

Interface 01 (Slot: MRI2) Network Global SyncE Info Datasets

Info

| | |
|-----------------|--|
| ID | HPS1 Cyclone5 High Performance Sync Module HPS100 2.0.3 2021-07-06 License (2048/262144) |
| S/N | 007411004770 |
| Kernel Version | Linux hps100 4.0.0 #1 SMP Tue Jul 6 13:06:36 CEST |
| eth1 | HWaddr EC:46:70:00:BF:9C |
| CPU Information | |
| FPGA Version | 522h |
| PTP Stack | 1.12-57 |

PTP Instances Instance 1 Instance 2

Packet Counter

| | |
|-------------------|---------|
| Announce Msg RX | 0 (0/s) |
| Announce Msg TX | 0 (0/s) |
| Sync Msg RX | 0 (0/s) |
| Sync Msg TX | 0 (0/s) |
| FollowUp Msg RX | 0 (0/s) |
| FollowUp Msg TX | 0 (0/s) |
| DelayReq Msg RX | 0 (0/s) |
| DelayReq Msg TX | 0 (0/s) |
| DelayResp Msg RX | 0 (0/s) |
| DelayResp Msg TX | 0 (0/s) |
| PDelayReq Msg RX | 0 (0/s) |
| PDelayReq Msg TX | 0 (0/s) |
| PDelayResp Msg RX | 0 (0/s) |
| PDelayResp Msg TX | 0 (0/s) |
| Signalling Msg RX | 0 (0/s) |
| Signalling Msg TX | 0 (0/s) |
| Mgmt Msg RX | 0 (0/s) |
| Mgmt Msg TX | 0 (0/s) |
| Num UC clients | 0 |
| Msg RX total | 0 (0/s) |
| Msg TX total | 0 (0/s) |
| Total Msg/sec | 0/s |

| # | IP | AnnRate | SyncRate | DlyRspRate | Last Req. |
|---|----|---------|----------|------------|-----------|
| Currently no active unicast connections | | | | | |

Webinterface: PTP → Configuration → Global

On the PTP Configuration page, the two instances of the PTP daemon can be configured independently, however, some constraints have to be kept in mind (see below).

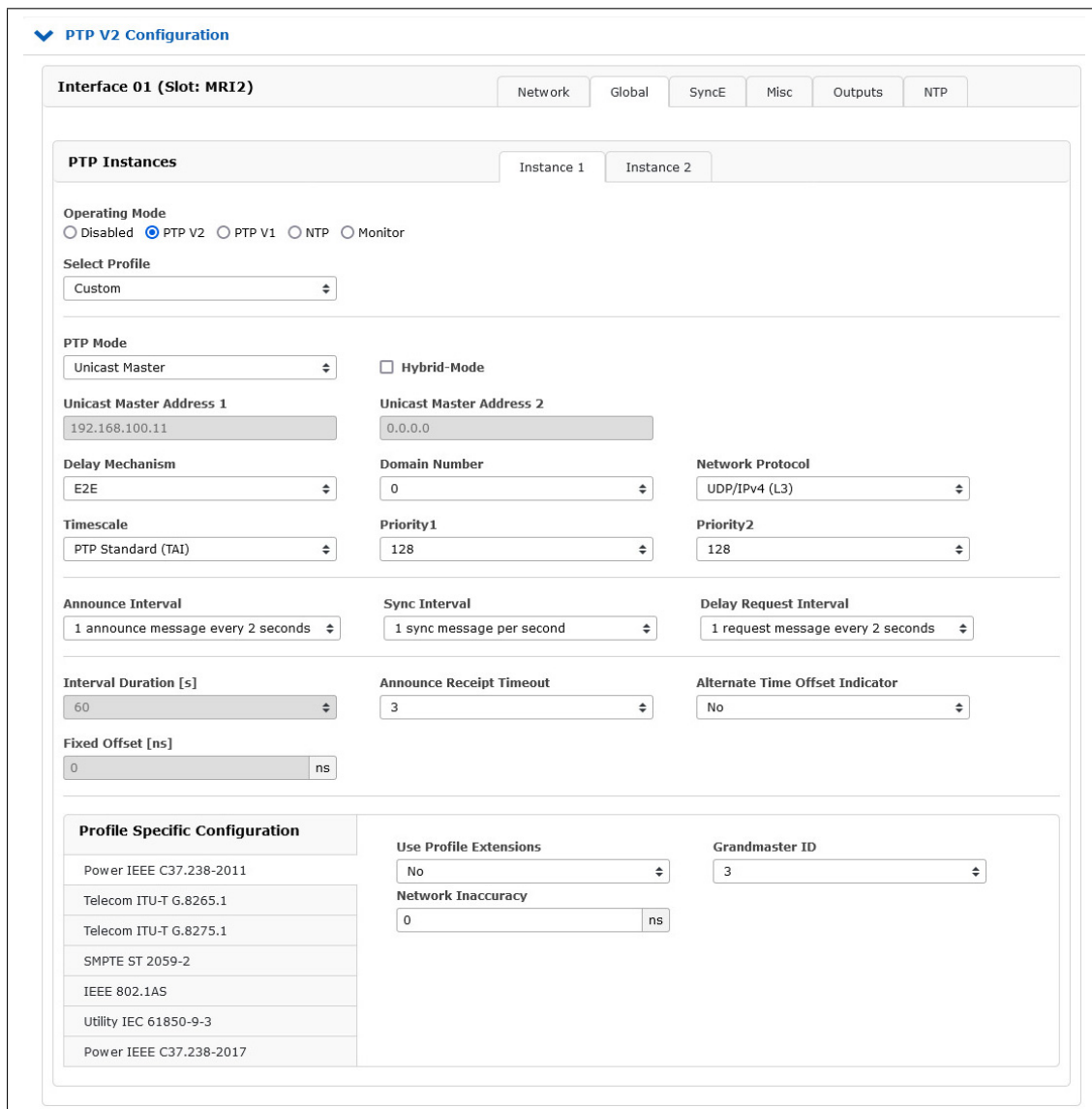

PTP V2 Configuration

Interface 01 (Slot: MRI2) Network Global SyncE Misc Outputs NTP

PTP Instances Instance 1 Instance 2

Operating Mode
 Disabled PTP V2 PTP V1 NTP Monitor

Select Profile
 Custom

PTP Mode
 Unicast Master Hybrid-Mode

Unicast Master Address 1
 192.168.100.11

Unicast Master Address 2
 0.0.0.0

Delay Mechanism
 E2E

Domain Number
 0

Network Protocol
 UDP/IPv4 (L3)

Timescale
 PTP Standard (TAI)

Priority1
 128

Priority2
 128

Announce Interval
 1 announce message every 2 seconds

Sync Interval
 1 sync message per second

Delay Request Interval
 1 request message every 2 seconds

Interval Duration [s]
 60

Announce Receipt Timeout
 3

Alternate Time Offset Indicator
 No

Fixed Offset [ns]
 0 ns

Profile Specific Configuration

| | | |
|-------------------------|-------------------------------------|----------------------------|
| Power IEEE C37.238-2011 | Use Profile Extensions No | Grandmaster ID 3 |
| Telecom ITU-T G.8265.1 | Network Inaccuracy 0 ns | |
| Telecom ITU-T G.8275.1 | | |
| SMPTE ST 2059-2 | | |
| IEEE 802.1AS | | |
| Utility IEC 61850-9-3 | | |
| Power IEEE C37.238-2017 | | |

Constraints and rules when configuring a PTP card in Dual Stack Mode

(two active PTP instances)

- Both instances must be PTPv2
- Both instances must be Master Only.
- 1-step clock operation is mandatory for both instances
- The configuration parameters of the two PTP instances must differ at least for one of the following parameters:
 - Domain Number
 - Network protocol (L2 or L3)
 - VLAN tag enabled

9.1.7 FDM - Frequency Deviation Monitoring

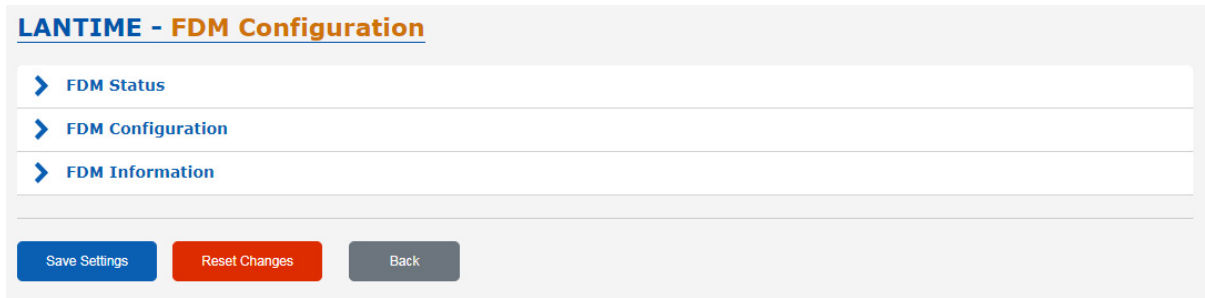

A preconnected reference is necessary to provide a serial time string, a PPS (pulse per second) signal and 10MHz frequency. The accuracy of the measurements is derived from these signals.

The module calculates the frequency as well as the time, based on the mains frequency. The time deviation (TD) is the difference of this calculated time (PLT) to the reference time (REF). This time deviation as well as the frequency itself is sent out via serial interface or is being converted to an analog voltage output provided by a DAC.

9.1.7.1 FDM Status

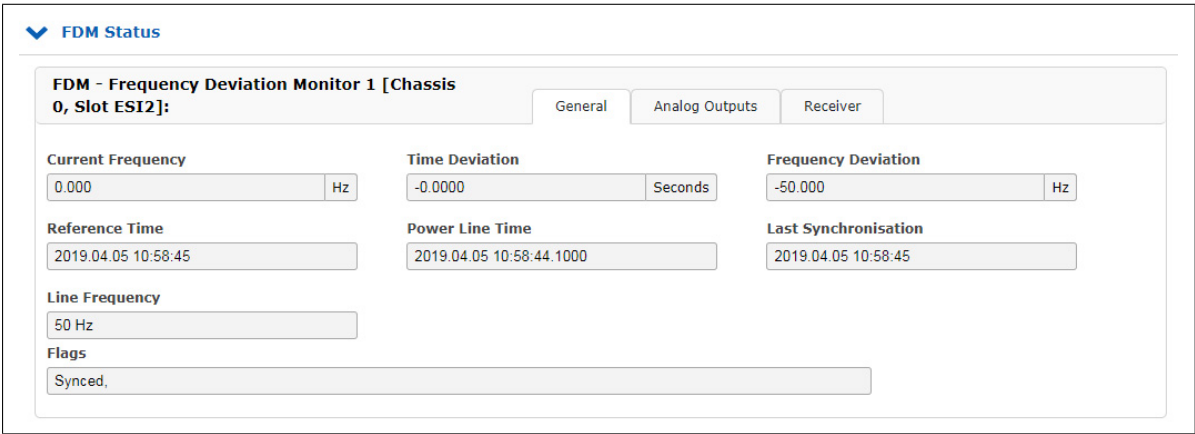

This menu shows the following values:

Current Frequency: The current frequency of the monitored power network

Reference Time: REF - the time of the reference clock (i.e. GPS)

Power Line Time: PLT - the time of the monitored power line

Line Frequency: 50 Hz or 60 Hz

Flags: Transmitted Flags by FDM (Error Bits)

Receiver State

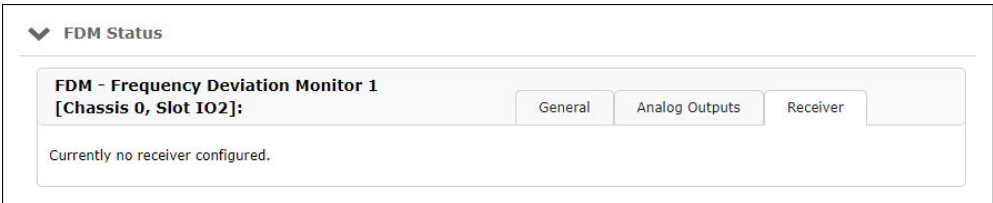

All receivers previously added in the FDM configuration are displayed in the TAB "Receiver".

9.1.7.2 FDM Configuration

Automatic Monitoring of Power Line Frequency

An upper and lower limit can be defined for the Power Line Frequency for the purpose of triggering alarm messages (by email, syslog, SNMP traps) whenever the LANTIME detects that the measured frequency is outside of an acceptable range.

The screenshot displays the 'FDM Configuration' page for 'FDM - Frequency Deviation Monitor 1 [Chassis 0, Slot ESI2]'. It features several tabs: 'General', 'Serial Port', 'Analog Outputs', 'Set TDEV', and 'New Receiver'. The 'General' tab is active, showing the following settings:

- Line Frequency:** 50 Hz (dropdown menu)
- Min Frequency:** 45000 mHz (input field)
- Max Frequency:** 55000 mHz (input field)
- Max Negative Time Deviation:** 100000 ms (input field)
- Max Positive Time Deviation:** 100000 ms (input field)
- Timezone:** (UTC) - UTC (dropdown menu)
- Activate Logging:** (checkbox)
- Restart FDM:** (button)

With the FDM configuration menu the following parameters can be set:

| | |
|-------------------------------------|--|
| Line Frequency: | Establishes the rated frequency of the monitored power line. |
| Min Frequency: | The lower threshold, specified in Millihertz, at which an alarm is triggered if the frequency drops below it. |
| Max Frequency: | The upper threshold, specified in Millihertz, at which an alarm is triggered if the frequency exceeds it. |
| Max Negative Time Deviation: | The lower threshold at which an alarm is triggered if the time deviation TDEV drops below this negative value in milliseconds. |
| Max Positive Time Deviation: | The upper threshold at which an alarm is triggered if the time deviation TDEV exceeds this positive value in milliseconds. |
| Timezone: | Local timezone used for Reference Time and Power Line Time. |
| Activate Logging: | Enables logging for FDM in XtraStats. |
| Reset FDM: | This is used to restart the FDM module only without having to manually remove the module or reboot your LANTIME. |

Configuration of Serial Ports

FDM Configuration

FDM - Frequency Deviation Monitor 1 [Chassis 0, Slot ES12]:

General Serial Port Analog Outputs Set TDEV New Receiver

COM 0

Baud Rate: 19200
Framing: 8N1
String Type: Standard
Mode: per second

COM 1

Baud Rate: 19200
Framing: 8N1
String Type: Standard
Mode: per second

Baud Rate: Specifies the transmission rate for serial time strings:
600, 1200, 2400, 4800, 9600, 19200

Framing: 7N2, 7E1, 7E2, 8N1, 8N2, 8E1, 7O2, 8O1

String Type: Type of generated serial time string:
Standard, Short, Areva (TTM1), TPC (TTM2),
Standard 2, Computime, Fingrid, FDM III

The Standard FDM string format contains the following values:
Mains Frequency (FF.xxx Hz)
Frequency Deviation (+-FF.xxx Hz)
Reference Time (HH:MM:SS)
Power Line Time (HH:MM:SS.mmm)
Time Deviation (+-SS.mmm) (+-SSS.mmm if TDEV \geq 99.999 ms)

Mode: Per second, per minute, or on request

Analog Outputs

The FDM180 provides two analog outputs (A1/A2), which are passed through a 3-pin MSTB connector, depending on the system. These outputs have a voltage range of -2.5V to + 2.5V, with 65,536 discrete values available in this range (16-bit resolution).

It is possible to select whether the displayed value should be the frequency deviation or the time deviation at each analog output.

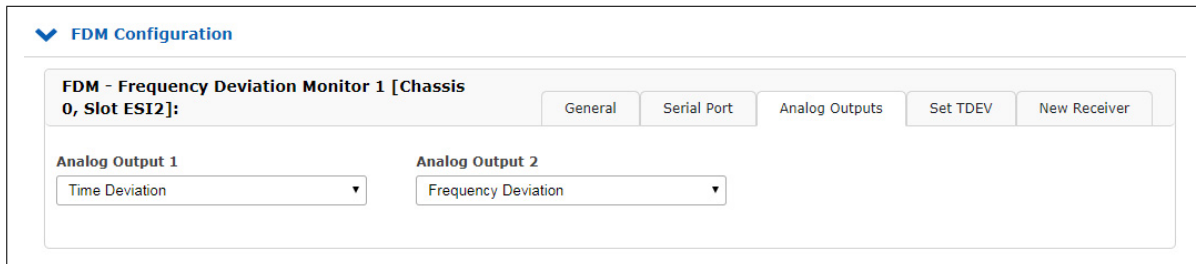

Mode:

Time Deviation: The output voltage is governed by the minimum and maximum limits defined for the time deviation.

For example, if min = -100 s and max = +100 s, and the time deviation falls to -100 s, the analog output delivers a voltage of -2.5 V, while with a deviation of +100 s, the output provides +2.5 V with a DAC resolution of 16 bits.

Frequency Deviation: The output voltage is governed by the min and max limits defined for the frequency deviation.

For example, if min = 45 Hz and max = 55 Hz with a mains frequency of 50 Hz, and if the frequency deviates by 45 Hz, the analog output delivers a voltage of -2.5 V, while if the frequency deviates by 55 Hz, the output provides +2.5 V with a DAC resolution of 16 bits.

Submenu Set TDEV

▼ FDM Configuration

FDM - Frequency Deviation Monitor 1 [Chassis 0, Slot ES12]: General Serial Port Analog Outputs **Set TDEV** New Receiver

Time Deviation (+/- ss.msmsms)

Compensation value will be used for calculating power line time

Set TDEV

Time Deviation: This is used to enter a static time deviation value (with preceding negative sign if necessary) for the Power Line Time. This time deviation value will be applied as soon as the reference clock is synchronized and a voltage is detected by the module.

Submenu New Receiver

This section can be used to add a new receiver for FDM strings. It is possible to add an arbitrary number of receivers (network displays and/or PCs for analysis and display of status messages or frequencies) to be connected to the same network.

- Receiver Type:** String type for network transmission
 Standard: Standard FDM time string
 Sent once per second
 e.g., "F:50.016 FD:+00.016 REF:15:17:57 PLT:15:17:57.056 TD:+00.056"
- Extended: Extended FDM time string with interim measurements and sequence ID
 Sent once per second
 e.g., "F:50.006 F:50.004 F:50.013 F:50.012 F:50.010 F:50.010 F:50.006 F:50.012 F:50.020"
 or "F:50.013 FD:+00.013 REF:15:19:10 PLT:15:19:10.071 TD:+00.071 SEQ:0000000004"
- Intermediate: Truncated FDM time string with intermediate measurements
 Sent once every 100ms
 M1:49.997 SEQ:0000000053
 M2:49.996 SEQ:0000000054
 M3:50.000 SEQ:0000000055
 M4:49.999 SEQ:0000000056
 M5:49.996 SEQ:0000000057
 M6:49.996 SEQ:0000000058
 M7:49.997 SEQ:0000000059
 M8:49.995 SEQ:0000000060
 M9:49.996 SEQ:0000000061
 M9:49.996 SEQ:0000000062
- Custom: Customized FDM time string, comprising prefix, string, and suffix
 Sent once per second
- Address:** Address or host name of the message recipient (display or computer)
- Port:** TCP/UDP port used for string transmission
- Transport Protocol:** Protocol used for string transmission (TCP/UDP)

Only if receiver type "Custom" is selected:

Prefix: Prefix of customized strings, control characters can be specified using their hex value (ASCII), for example:
 "\x01" for SOH (Start of Header) or "\x02" for SOT (Start of Text)

String: Customized time string, which may consist of any text and the following variables (identified by the prefix '%'):

| | |
|-------------|---|
| PLFRQ | Power Line Frequency (e.g., 50.023) |
| FRQDEV | Frequency Deviation (e.g., +00.023) |
| REFTIME | Reference Time (e.g., 15:17:23) |
| POWERLNTIME | Power Line Time (e.g., 15:17:22.550) |
| PLTDEV | Power Line Time Deviation (e.g., -00.450) |
| IDX | Intermediate Measurement Index (e.g., 1) |
| IMMFRQ1 | Intermediate Measurement Frequency with Index 1 (e.g., 50.034) |
| IMMFRQ2 | Intermediate Measurement Frequency with Index 2 (e.g., 50.034) |
| ... | |
| SEQID | Sequence ID (e.g., 0000000061) |
| SYSTIME | System Time (e.g., 15:17:23) |
| SYNCSTATE | Synchronization Status (" " = synchronized, "*" = not synchronized) |
| SYNCTEXT | Synchronization Text ("OK" = synchronized, "NO" = not synchronized) |
| TIMESTAMP | Current Timestamp (e.g., 2016-03-15 16:03:10.042) |
| TIMESTRING | Time string to set the display time (e.g., S16:04:37;15.03.16S) |

An auto-toggle feature allows a sequence of formats to be defined by configuring comma-separated format strings. Additionally, the duration of a format string can be defined using the *FORMATSTR@DURATION* format.

The example below displays the Power Line Frequency for 20 seconds, then the Reference Time for 30 seconds, then the Frequency Deviation for 10 seconds. It then restarts the sequence from the beginning with the PLF display again:

```
PLF %PLFRQ Hz@20,REF %REFTIME@30,FDV %FRQDEV@10
```

Suffix: Suffix for customized strings, control characters can be specified using their hex values (ASCII), for example:
 "\x0A" for LF (Line Feed) or "\x0D" for CR (Carriage Return)

Append

Timestamps: Specifies whether a timestamp should be appended to the message.

9.1.7.3 FDM Information

▼ **FDM Information**

FDM - Frequency Deviation Monitor 0 [Chassis 0, Slot ES12]:

Common Information

| Name | Value |
|--------------------|------------------|
| Model: | FDM180 (58) |
| Serial Number: | 048811001980 |
| Software Revision: | v1.23 (Standard) |

| Temperature Sensor 1 | | Temperature Sensor 2 | |
|----------------------|---------|----------------------|---------|
| Current: | 26.50°C | Current: | 24.00°C |

9.1.7.4 Serial FDM Telegrams

9.1.7.5 Standard FDM String

The STANDARD string is a sequence of 62 ASCII characters containing the frequency F, the frequency deviation FD, the REF time, the power line time PLT and the time deviation TD, each item separated by a space character. The string is sent out at the beginning of every new REF time second and ends with the characters Carriage-Return (Hex code 0Dh) and Line-Feed (Hex code 0Ah). The letters displayed in italics are replaced by the calculated values whereas the other characters are part of the string:

*F:49.984*_FD:-00.016_REF:15:03:30_PLT:15:03:30.378_TD:+00.378<CR><LF>

The meaning of the several values is described below:

| | |
|-------------------------|---|
| <i>F:49.984</i> | The measured power line frequency with a resolution of 1 mHz |
| <i>FD:-00.016</i> | The frequency deviation between calculated and nominal frequency, with sign character (+/-), resolution: 1 mHz, maximum: +-09.999 Hz |
| <i>REF:15:03:30</i> | The reference time from the preconnected clock (hours:minutes:seconds) |
| <i>PLT:15:03:30.378</i> | The power line time, based on the mains frequency, (hours:minutes:seconds.milliseconds) Time jumps, like changeover in daylight saving or leap seconds will not be executed by the PL time! |
| <i>TD:+00.378</i> | The time deviation between REF time and PL time, with sign character (+/-), resolution: 1ms, maximum: +-99.999s |

9.1.7.6 FDM Standard 2 Telegramm:

Like FDM standard, but it sends every 500 ms instead of 1 per second.

9.1.7.7 Short FDM String

The SHORT string is a sequence of 23 ASCII characters containing simply information about frequency deviation FD and time deviation TD, separated by a space character. The string is sent out at the beginning of every new REF time second and ends with the characters Carriage-Return (Hex code 0Dh) and Line-Feed (Hex code 0Ah). The letters displayed in italics are replaced by the calculated values whereas the other characters are part of the string:

*FD:-00.016*_TD:+00.378<CR><LF>

The meaning of the several values is described below:

| | |
|-------------------|--|
| <i>FD:-00.016</i> | The frequency deviation between calculated and nominal frequency, with sign character (+/-), resolution: 1 mHz |
| <i>TD:+00.378</i> | The time deviation between REF time and PL time,, with sign character (+/-), resolution: 1 ms |

9.1.7.8 FDM Areva String

The Areva string is a sequence of 71 ASCII characters containing the frequency F, the frequency deviation FD, the time deviation TD, the power line time PLT and the reference time REF (preceded by the 3 digit day-of-the-year), each item separated by the characters Carriage-Return (Hex code 0Dh) and Line-Feed (Hex code 0Ah). Each of the five data items is preceded by a fixed 3 digit address (020 ... 024). The string starts with the STX character (start-of-text, Hex code 02h) and ends with a terminating ETX character (end-of-text, Hex code 03h) on time with the change of the REF time seconds. The letters displayed in italics are replaced by the calculated values whereas the other characters are part of the string:

```
<STX> 02049.984<CR><LF>
021-0.016<CR><LF>
022+00.378<CR><LF>
02315_03_30.378<CR><LF>
024068_15_03_30_<CR><LF>
<ETX>
```

The meaning of the several values is described below:

| | |
|--------------|---|
| 49.984 | The measured power line frequency with a resolution of 1 mHz |
| -0.016 | The frequency deviation between alculated and nominal frequency, with sign character (+/-), resolution:1 mHz |
| +00.378 | The time deviation between REF time and PL time, with sign character (+/-), resolution: 1 ms |
| 15_03_30.378 | The power line time, based on the mains frequency, (hours_minutes_seconds.milliseconds) Time jumps, like changeover in daylight saving or leap seconds, will not be executed by the PL time! |
| 068_15_03_30 | The reference time from the preconnected clock, (day-of-the-year_hours_minutes_seconds) |

9.1.7.9 TPC FDM String

The TPC string is a sequence of 29 ASCII characters containing the REF time (with day-of-the-year), the time deviation TD and the frequency deviation FD. The string starts with the SOH character (start-of-header, ASCII code 01h) on time with the beginning of every new REF time second and ends with the characters Carriage-Return (ASCII code 0Dh) and Line-Feed (ASCII code 0Ah). The letters displayed in italics are replaced by the calculated values whereas the other characters are part of the string:

<SOH>288:10:11:29 -00.03F+50.01<CR><LF>

The meaning of the several values is described below:

| | |
|---------------------|---|
| 288:10:11:29 | the reference time from the upstream radio clock, (day of year:hours:minutes:seconds) |
| " " or "?" | if reference time is synchron then " " otherwise "?" |
| -00.03 | the mains frequency deviation from the setpoint, resolution 1 mHz |
| F+50.01 | The power line frequency, 10 mHz resolution |

9.1.7.10 Computime Extended FDM String

The extended Computime string is a sequence of 42 ASCII characters containing the REF time (with date and day-of-the-week), the time deviation TD and the frequency F. The string is send out at the beginning of every new REF time second and ends with the characters Carriage-Return (Hex code 0Dh) and Line-Feed (Hex code 0Ah). The letters displayed in italics are replaced by the calculated values whereas the other characters are part of the string:

T:10:03:09:02:15:03:30D:+000.378F:49.984<CR><LF>

The meaning of the several values is described below:

| | |
|----------------------|--|
| T:10:03:09:02 | The date of the reference time from the preconnected clock, (year:month:day:day-of-the-week / Monday = 01, Sunday = 07) |
| 15:03:30 | The reference time from the preconnected clock, (hours:minutes:seconds) |
| D:+000.378 | The time deviation between REF time and PL time, with sign character (+/-), resolution: 1ms, maximum: +-99.999s (the first digit is always 0!) |
| F:49.984 | The measured power line frequency with a resolution of 1 mHz |

9.1.7.11 FDM Fingrid String

The fingrid telegram consists of a sequence of 34 characters and contains the reference time, the time deviation and the frequency deviation. It ends with the characters carriage return (hex code 0Dh) and line feed (hex code 0Ah).

079:08:13:55.000 T+6.780F+0.012<CR><LF>

079:08:13:55.000 reference time from the preconnected clock,
(yeardays:hours:minutes:seconds:milliseconds)

T+6.780 the time deviation between REF time and PL time,
with sign character (+/-), resolution: 1 ms

F+0.012 The frequency deviation between calculated and nominal frequency,
with sign character (+/-), resolution: 1 mHz

Configure the fingrid telegram for the corresponding serial interface and use the mode "On request only (?)".
Send T or ? to get the respond string exactly with the change of the next second within 1 s.

Example for the request of the Fingrid time telegram:

Date: 20 March 2017
Time: 08:13:55 (UTC)
Time Deviation: +6.780 s
Frequency Deviation: +0.012 Hz

to FDM ← *T or ? (at 08:13:54.xxx)*
from FDM → *079:08:13:55.000 T+6.780F+0.012<CR><LF>*

To correct the time deviation TD, please use the specified format. If the time deviation TD is accepted, the FDM confirms the command and applies the value within the next 2 seconds.

Example of setting TD to 6.780 seconds:

to FDM ← *F27 B3 PS +6.780<CR><LF>*
from FDM → *F27<CR><LF>*

9.1.7.12 FDM III String

Configure FDM III string in serial parameters (for corresponding serial port) as output string type.

Example of FDM III String:

Date: 09 March 2017
 Time: 12:17:55 (UTC)
 Time Deviation: -1.573s
 Frequency Deviation: +0.095Hz

068:12:17:55?T-01.537F+0.123SF+60.095ST12:17:53.463<CR><LF>

| | |
|-----------------------|--|
| 068:12:17:55 | Reference time from the preconnected clock, (yeardays:hours:minutes:seconds) |
| ? | Local FDM status (" " sync or "?" not sync) |
| T-01.537 | The time deviation between REF time and PL time, with sign character (+/-), resolution: 1 ms |
| F+0.123 | The frequency deviation between calculated and nominal frequency, with sign character (+/-), resolution: 1 mHz |
| SF+60.095 | The measured power line frequency with a resolution of 1 mHz |
| ST12:17:53.463 | The power line time, based on the mains frequency, (hours:minutes:seconds.milliseconds) |

9.1.7.13 Error-Bits

The FDM module registers errors and overflows and sets or deletes eight error bits then. In this way, the user can find out if an "Overflow" occurs for example. These error bits document various error causes that occurred during operation.

The displayed value has the format: *X8 X7 X6 X5 X4 X3 X2 X1*

- X8:** A2 Overflow, analog output 2 has reached its final value
- X7:** A1 Overflow, analog output 1 has reached its final value
- X6:** Time Deviation Overflow, the time difference is greater than +- 99.999s
- X5:** Frequency Overflow, the frequency deviation is greater than the configured max./min values
- X4:** REF Free, no sec-impulse from the reference
- X3:** Power Line Time Free, no power line frequency (power line time remains at the last value)
- X2:** No Time String, no serial time telegram received
- X1:** No Power Line Time Init, the power line time has not (yet) been initialized

The error bits can be read out serially on request by an "E" (ASCII code 45h) via the interfaces COM 0/1.

The format of the response string is:

ERROR:X8X7X6X5X4X3X2X1<CR><LF>

9.1.8 System

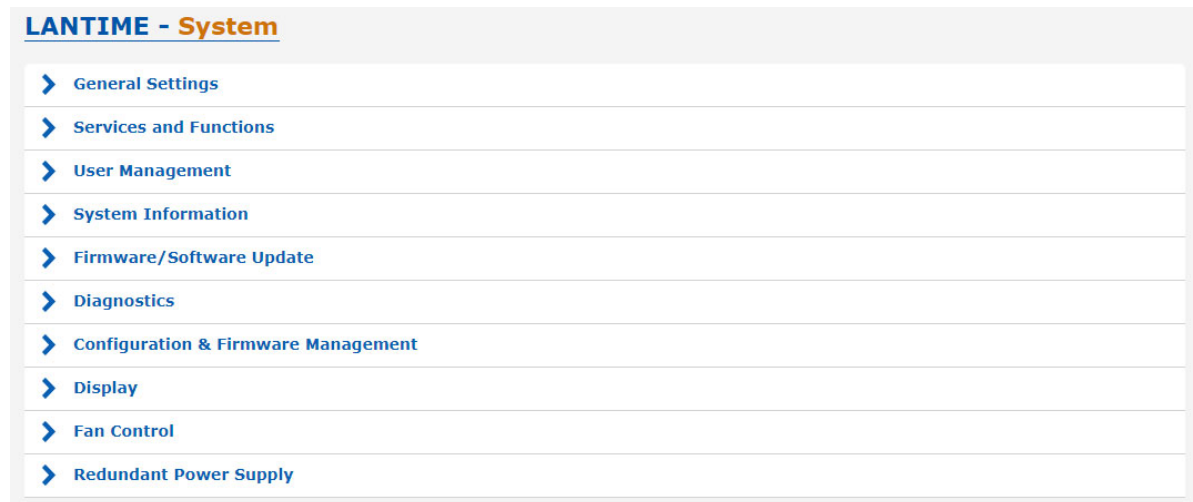

9.1.8.1 General Settings

General Settings

| | |
|---|---|
| <p>Contact</p> <input style="width: 90%;" type="text" value="USER 1"/> | <p>Location</p> <input style="width: 90%;" type="text" value="Rack on table"/> |
| <p>Rest API: GPS Position</p> <input style="width: 90%;" type="text" value="AUTO"/> <p style="color: red; font-size: small;">Insert AUTO if you want to take over the calculated GNSS Position (if available).</p> | |
| <p>Web Interface Language</p> <div style="border: 1px solid #ccc; padding: 2px; display: flex; align-items: center;"> English ⇅ </div> | |
| <p><input type="checkbox"/> Auto Expand Menus</p> <p><input type="checkbox"/> Automatically Activate Config Changes As Startup Config</p> <p><input checked="" type="checkbox"/> Enable REST API</p> <p><input type="checkbox"/> Enable Discovery</p> | |

Contact:

An input field for storing the contact information. The information is also displayed on the main page of the web interface and can be queried via SNMP.

Location:

An input field for storing the device location. The information is also displayed on the main page of the web interface and can be queried via SNMP.

Rest API: GPS Position

The entered value will be output as GPS position of the LANTIME via the REST API.

Web Interface Language:

Language setting of the web interface.

Auto Expand Menus:

If this feature is enabled all sub-menus will be expanded in each configuration dialogue.

Automatically Activate Config Changes As Startup Config:

If this option is enabled, each configuration change is immediately added to the startup configuration of the LANTIME (the startup configuration is the configuration that is used when the LANTIME is booted). If the option is not activated, the following note is displayed in the header of the Web interface after each configuration change.



Each configuration change can then be saved as start configuration by confirming with "Save as startup configuration now" button.

REST API Support

In the 7.04 release, a REST API interface is offered for the first time to retrieve status information and make configuration adjustments from external management systems over a secure HTTPS connection. The available objects are stored in a JSON-based syntax as a tree structure. The REST API can be enabled and disabled as a service by configuration. An explanation of all available objects is included in an integrated online help in the firmware and can be accessed via the Web UI: <https://YOUR-LANTIME-IP-ADRESS/clihelp/>

Enable Discovery

The LANTIME provides information for a better mapping in the Meinberg Network Management System (mbgNMS).

9.1.8.2 Services and Functions

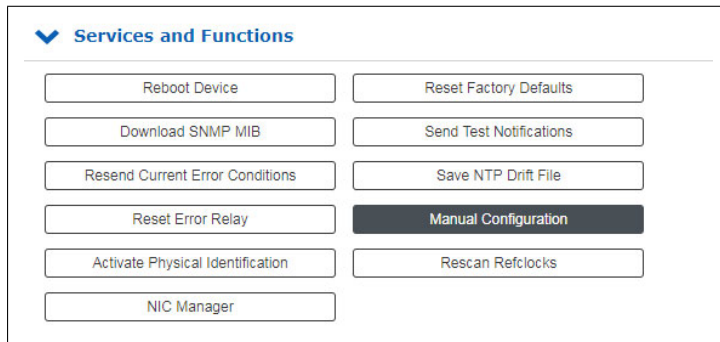
**Reboot Device:**

Initiates a restart of the LANTIME operating system. The built-in reference clock and output signals generated by the clock remain unaffected.

Download SNMP MIB:

Download the Meinberg SNMP MIB files. The archive file contains all Meinberg SNMP MIB files. To monitor a LANTIME time server with a V7 firmware via SNMP, only the MBG-SNMP-ROOT-MIB.mib and MBG-LANTIME-NG-MIB.mib files from the archive file are required.

Resend Current Error Conditions:

The button can be used to send the user the LANTIME error logs via e-mail or SNMP Trap. In order to use this function, the error events must be activated on the "Notification" page under "Notification Events" for the desired channel (eg e-mail or SNMP). An e-mail receiver or SNMP trap receiver must also be configured.

Reset Error Relay:

With this button the error relay can be set to an error-free position.

Activate Physical Identification:

This function can be used to find a LANTIME device. After the button is activated, the LANTIME starts to beep once per second and the alarm LED at the front panel flashes red. The function is terminated by pressing the "F2" button on the front panel.

Reset Factory Defaults:

Resets the LANTIME to factory defaults. (Attention: The network settings are retained during the reset via the web interface. If the network settings need to be reset as well, the reset must be initiated via the front panel.) During the reset, LANTIME restarts. After restarting the LANTIME can be reconfigured with the default user "root" and password "timeserver".

Send Test Notifications:

Sending a test notification to the configured e-mail recipients and / or SNMP trap receivers.

Save NTP Drift File:

The NTP service determines the offsets of the system clock at runtime and stores them in the so-called NTP drift file. This file is used by the NTP service to automatically adjust the system clock, even if no time source is currently available at short notice.

The "Save NTP Drift File" function saves the current NTP drift file `/etc/ntp.drift` on the internal Compact Flash card at `/mnt/flash/data/ntp.drift`. When the LANTIME is restarted, the value from the stored drift file can be read out by the NTP service, which accelerates the initial time adjusting process.

Manual Configuration:

The "Manual Configuration" button allows a direct access to the configuration files of the LANTIME. This feature should only be used by experienced administrators.

NIC Manager

The NIC Manager checks the system for physical network interfaces. This applies to the additional interfaces that can be added to the system via LNE modules. After the installation and initialization of an LNE card, the function must be executed so that the file `"etc/mbg/net.cfg"` is rewritten. The network port status can then be displayed on the start page of the web interface.

The NIC Manager function should also be executed after removing or replacing an LNE. The system uses the MAC addresses of the individual network ports to check whether they exist, whether their position (slot) in the system has changed or whether new interfaces exist.

Rescan Refclocks

This function must be executed if a second clock is subsequently installed in IMS systems in order to obtain a redundant receiver configuration. After start-up, the system remembers the serial connection of the reference clock used. If, for example, an M3000- or M1000 system with built-in RSC a second clock will be installed during operation (hot-plug), the "Rescan Refclocks" button must be pressed to register the new clock so that the serial connection of the second clock will be saved on the system.

9.1.8.3 Manual Configuration

LANTIME - System

Manual Configuration

⊗ Use the manual configuration only if you are a qualified administrator who is knowledgeable about the system. ⊗

▼ **Standard Configuration**

Notification Settings

Miscellaneous Configuration

▼ **Network Configuration**

Network Configuration

▼ **NTP Configuration**

NTP Configuration

- Notification Settings
- Miscellaneous Configuration
- Network Configuration
- NTP Configuration
- NTP Broadcast Configuration

With "Manual configuration" you are able to change the main configuration by editing the configuration file by hand. After editing, press the "Save file" button to preserve your changes, afterwards you are asked if your changes should be activated by reloading the configuration (this results in reloading several subsystems like NTPD, HTTPD etc.).

9.1.8.4 User Management

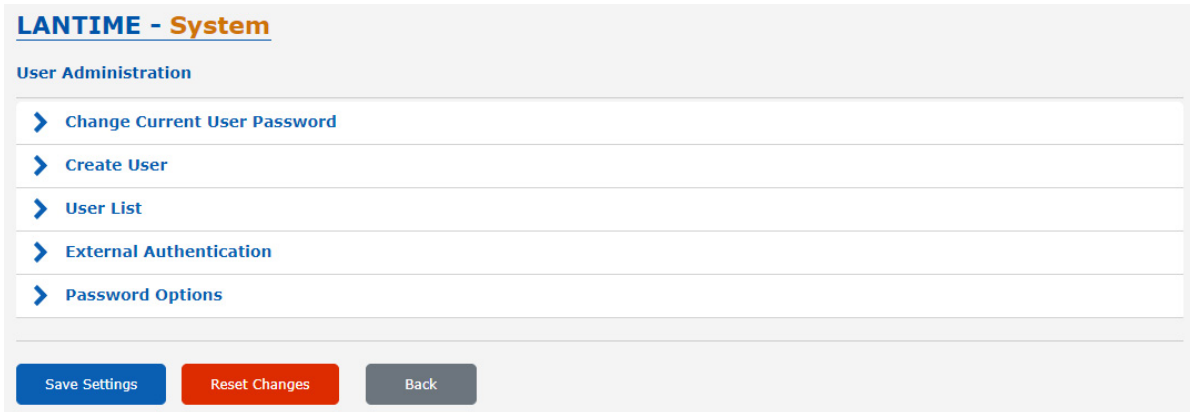

The screenshot shows the 'LANTIME - System' user administration interface. It features a list of menu items: 'Change Current User Password', 'Create User', 'User List', 'External Authentication', and 'Password Options'. At the bottom, there are three buttons: 'Save Settings' (blue), 'Reset Changes' (red), and 'Back' (grey).

Change Current User Password

Here you can change the password of the currently authenticated user.

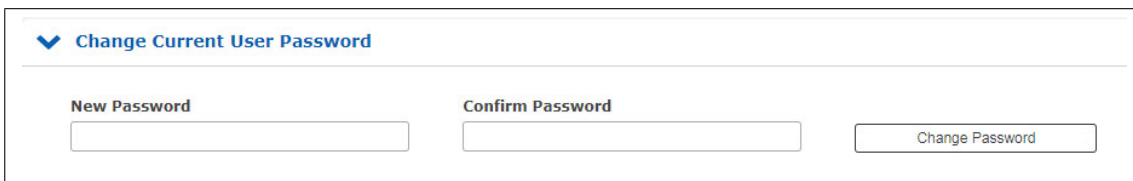

The screenshot shows the 'Change Current User Password' form. It has a title 'Change Current User Password' with a dropdown arrow. Below the title are two input fields: 'New Password' and 'Confirm Password'. To the right of the 'Confirm Password' field is a 'Change Password' button.

Create User

It is possible to create multiple user accounts on a LANTIME system, each account can be assigned one of three access levels: the Super-User level has full read-write access to the configuration of the LANTIME system, it can modify all parameters and has full shell access to the system when logging in via Telnet, SSH or serial console port. Administrator level accounts can only modify parameters via the WEB interface but does not have shell access. The access level "Info" can only review status and configuration options but is not allowed to modify any parameters or configuration files.

The table below illustrates the user-rights of each access level in detail.

| | Super User | Admin User | Info User |
|---|------------|------------|-----------|
| Full access to the Command Line | ✓ | | |
| Change device configuration through the WebUI | ✓ | ✓ | |
| Editing of the additional configuration files, which are available through the WebUI* | ✓ | | |
| Perform a Firmware Update | ✓ | | |
| Create a diagnostic file | ✓ | | |
| Create a new super user account | ✓ | | |
| Review all webinterface configuration values | ✓ | ✓ | ✓ |

*Additional Network Configuration, Additional NTP Configuration, User defined notifications

User List

This submenu gives you an overview of all configured LANTIME users. By clicking "Delete User" a single user can be deleted.

▼ User List

| User Name | Group Membership | Option |
|-----------|------------------|--|
| root | Super-User | <input type="button" value="Delete User"/> |
| admin2 | Admin-User | <input type="button" value="Delete User"/> |
| info2 | Info-User | <input type="button" value="Delete User"/> |
| info3 | Info-User | <input type="button" value="Delete User"/> |

9.1.8.5 External Authentication Options

The screenshot displays the 'External Authentication' configuration page. At the top, there is a dropdown menu labeled 'External Authentication' with two visible options: 'Radius/TACACS+' and 'LDAP'. Below this, the 'Radius/TACACS+' section is active, showing sub-tabs for 'Misc', 'Add Server', and 'Server List'. In the 'Misc' tab, there is a checked checkbox for 'Enable External Authentication' and a text input field for 'Timeout (ms)' with the value '0'.

The LANTIME supports Radius and TACACS as external authentication methods.

Enable External Authentication:

Through this checkbox you can either enable or disable the external authentication feature of the LANTIME.

Timeout (ms):

Period of time how long to wait for an "access accept" packet from an authentication server.

You can choose between several Authentication Methods:

1. LDAP
2. RADIUS
3. TACACS+

9.1.8.6 LDAP / LDAPS

Lightweight Directory Access Protocol

LDAP is based on the client-server model and is used for so-called directory services. LDAP describes the communication between the LDAP client and the directory server. Object-related data, such as personal data or computer configurations, can be read from such a directory.

9.1.8.7 LDAP Setup

Example LDAP setup in connection with the Microsoft Active Directory (AD)

This chapter describes an example for setting up an LDAP connection with the Microsoft Active Directory with non-standard attributes of an admin user. Please note that this is an example only and may not be directly applicable to your directory structure. Please contact your directory service administrator to identify any discrepancies and make any necessary adjustments.

The ADSI editor of the Microsoft Active Directory is used to adjust the following attributes of an LDAP user in this example:

- gidNumber = 4
- sAMAccountName = ldap-ad
- uidNumber = 10020
- unixHomeDirectory = /home/ldap-ad
- loginShell = /bin/false

The name of the user (ldap-ad) the uidNumber and the "HomeDirectory" name are freely selectable. These are only example values. Also the attributes (e.g. sAMAccountName) can be freely chosen by the mapping. It is only important that a mapping of the attribute selected in the directory service is defined by the attribute provided for this purpose in the RFC ("shadow uid sAMAccountName" for this example).

The **gidNumber** can also be specified in a group of the directory service (Secondary Group Support). The user then still needs a primary group, but it has no meaning for a LANTIME. For this purpose, the user can map the **gidNumber** to the AD attribute **primaryGroupID**, for example.

After specifying "LDAP User", "LDAP Password", "Search Scope" and "Search Base", the filters and mappings can be defined. The LDAP user/binddn is required to read information from the AD, and is not normally a user to log into this machine afterwards.

The screenshot displays the 'External Authentication' configuration page for LDAP. At the top, there are tabs for 'Radius/TACACS+' and 'LDAP'. A green notification banner at the top left states 'LDAP service is up and running.' Below this, there is a checkbox for 'Anonymous Bind' which is currently unchecked. The 'LDAP User/binddn' field contains 'Administrator@test.mbg_support.de' and the 'LDAP Password' field is masked with dots. The 'Search Scope' dropdown menu is open, showing options: 'sub', 'base', 'one', and 'sub'. The 'Search Base' field contains 'CN=Users,DC=test,DC=mbg_support,DC=de'. There are 'Filter' and 'Mapping' buttons. Below the configuration fields, there is a section for 'LDAP Server 01' with 'Global' and 'Misc' tabs. It includes a 'Remove LDAP Server' button (in red), a 'Test Connection' button (in blue), and an 'Add LDAP Server' button (in green) at the bottom.

Figure: Web interface menu "System → User Administration → External Authentication → LDAP"

In the sample domain `test.mbg.de` the "Search Base" `"CN=Users,DC=test,DC=mbg"` was selected and the "Search-Scope" was set to "sub".

The following filters and mappings must be added to this sample configuration via the web frontend of LTOS.

Filter:

- passwd (&(objectClass=user)(unixHomeDirectory=*))
- shadow (&(objectClass=user)(uidNumber=*)(unixHomeDirectory=*))

The screenshot shows the 'Advanced LDAP Configuration' interface with the 'Filter' tab selected. It lists two filters, each with a checked checkbox and a text input field containing the filter expression. Below the filters is a green 'Add Filter' button.

Figure: LDAP sub menu "Advanced LDAP Configuration → Filter"

Mappings:

- passwd uid sAMAccountName
- passwd homeDirectory unixHomeDirectory
- shadow uid sAMAccountName

The screenshot shows the 'Advanced LDAP Configuration' interface with the 'Mapping' tab selected. It lists three mappings, each with a checked checkbox and a text input field containing the mapping expression. Below the mappings is a green 'Add Mapping' button.

Figure: LDAP sub menu "Advanced LDAP Configuration → Mapping"

The `gidNumber` can sometimes conflict with group membership on other systems. Ask your directory service administrator for possible avoidance strategies.

After the URI of the LDAP server is assigned, the settings can be saved. If LDAP is selected as the protocol, the configured LDAP users can log in via the web frontend (and the CLI if a loginShell has been assigned for the super user). If LDAPS is selected as protocol, the rootca certificate that uniquely identifies the LDAP server (see [CA Certificates](#)) must be added beforehand.

In case of problems, the connection can be tested under "Misc" of the respective LDAP server entry. Here the basic connectivity is checked with the mandatory values URI, bind dn and search base. The status of the LDAP functionality is shown in the banner of the LDAP tab.

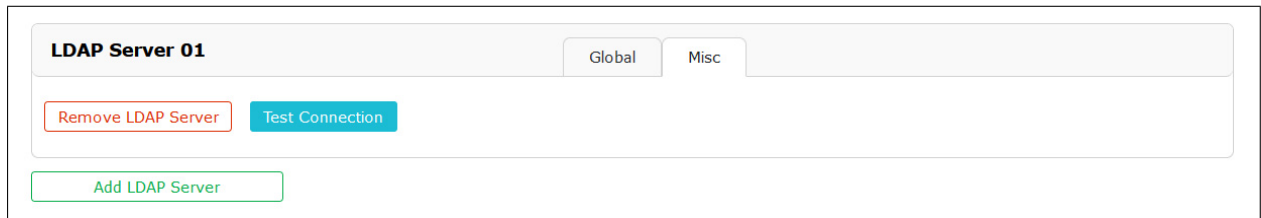

9.1.8.8 RADIUS

Radius stands for Remote Authentication Dial In User Service and provides centralized authentication for LANTIME devices. RADIUS is a client/server protocol that runs in the application layer, using UDP as transport protocol.

The LANTIME RADIUS authentication requires that each account that should be able to login to the LANTIME has a Vendor Specific Attribute (VSA) called MBG-Management-Privilege-Level configured. This VSA has to be added to the RADIUS configuration of an external authentication server. Here some additional Information on the attribute:

```
Name = MBG-Management-Privilege-Level
Datatype = Integer
Vendor-Code = 5597
Vendor assigned attribute number = 1
Value range = 100, 200, 300
```

In addition you need to assign a value of 100 (Super User), 200 (Admin User) or 300 (Info User) for this attribute for each RADIUS user, which should be able to login to the LANTIME.

9.1.8.9 TACACS

Terminal Access Controller Acc-Control System is a remote authentication protocol that gives the LANTIME the possibility to communicate with a TACACS authentication server.

The LANTIME TACACS authentication requires that each account that should be able to login to the LANTIME has configured an attribute called "priv-lvl". This attribute needs to be configured on the TACACS Server.

For a Super-User account the attribute has to be "100", for an Admin account "200" and for an Info User account "300". In the following an example of a tac_plus server configuration file:

```
# This is the shared secret that clients have to use to access Tacacs+
key = meinberg

# User Groups

group = lantime_super_user {
    service = lantime_mgmt {
        priv-lvl = 100
    }
}

group = lantime_admin_user {
    service = lantime_mgmt {
        priv-lvl = 200
    }
}

group = lantime_info_user {
    service = lantime_mgmt {
        priv-lvl = 300
    }
}

# User

# LANTIME Super User
user = tacacs_su {
    member = lantime_super_user
    pap = cleartext „tacacs_su“ # User Password
}

# LANTIME Admin User
user = tacacs_au {
    member = lantime_admin_user
    pap = cleartext „tacacs_au“ # User Password
}

# LANTIME Info User
user = tacacs_iu {
    member = lantime_info_user
    pap = cleartext „tacacs_iu“ # User Password
}
```

Add External Authentication Server

▼ Add External Authentication Server

| | |
|---|--|
| <p>Authentication Method</p> <input style="width: 90%;" type="text" value="Radius"/> | <p>Authentication Server</p> <input style="width: 90%;" type="text"/> |
| <p>Shared Secret</p> <input style="width: 90%;" type="text"/> | <p>Port</p> <input style="width: 90%;" type="text" value="1812"/> |

Add Authentication Server

Through this form you can add an external authentication server to the LANTIME configuration. The external authentication has to be enabled first in the "External Authentication Options" menu.

Authentication Method:

Configuration of the authentication method to use, either Radius or TACACS+. More detailed information on both methods can be found in the upper part of this chapter..

Authentication Server:

The IP or Host of the selected Authentication Server (IPv4 and IPv6 are supported).

Shared Secret:

A shared secret is used for a basic authentication between a LANTIME and the authentication server. The shared secret of the external authentication server has to be entered in this field. A list of allowed signs which can be used for the shared secret you can find in the chapter "Before you Start → Text and Syntax Conventions")

Port:

Depending on the authentication method, the default port is already configured here. If needed, the port can be changed.

External Authentication Server List

▼ External Authentication Server List

| Authentication Server | Port | Authentication Method | Option |
|-----------------------|------|-----------------------|---|
| pc-greg2 | 1812 | Radius | Delete Server |
| pc-greg3 | 1812 | Radius | Delete Server |

This table gives you a quick overview of the configured authentication servers. Each server can be removed by either a Super- or Admin-User by clicking the "Delete Server" button.

9.1.8.10 Password Options

▼ Password Options

Minimum Password Length
3

Allow secure passwords only

Users must change password periodically

Disable password autocompletion in browser

Interval
Monthly

This sub menu provides some general password settings.

Minimum Password Length:

This parameter sets the minimum number of characters of a password before it is accepted by the system as a valid password. This value is used when creating a new user as well as when you change a current user password. Former created passwords are not affected. The maximum length of a password is 64 characters.

Allow secure passwords only:

If this option is activated, only secure passwords will be allowed. A secure password needs at least:

- one lower character [a-z]
- one upper character [A-Z]
- one digit [0-9]
- one special character

A list of allowed signs which can be used as special characters you can find in the chapter "Before you Start → Text and Syntax Conventions")

Users must change password periodically:

Users will be forced to change passwords at regular intervals. If a password is expired the user can not log in to the unit before changing his current password. Possible intervals:

- Monthly
- Quarterly
- Half-Yearly
- Yearly

Disable password autocompletion in browser:

After this feature is enabled, your browser will not autocomplete the credentials of a LANTIME.

9.1.8.11 System Information

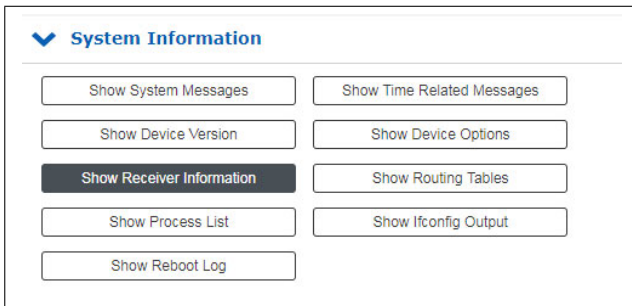

The "System Information" menu offers the possibility to view important log files and setups of the LANTIME.

| | |
|------------------------------------|---|
| Show System Messages: | Displaying the LANTIME SYSLOG file stored in <code>/var/log/messages</code> |
| Show Device Version: | Displaying the additional device information (model, firmware, serial number, built-in hardware components, etc.) |
| Show Receiver Information: | Displaying the additional status information on the built-in reference clock. |
| Show Process List: | Displaying of all currently running processes. |
| Show Reboot Log: | Displaying the reboot logs stored in <code>/mnt/flash/data/reboot.log</code> . The log file contains information about past system reboots. |
| Show Time Related Messages: | Displaying the file <code>/var/log/lantime_messages</code> . |
| Show Device Options: | Displaying additional system parameters. |
| Show Routing Tables: | Displaying the network routing table. |
| Show Ifconfig Output: | Displaying information for all network interfaces (output of the command <code>"ifconfig -a"</code>) |

9.1.8.12 Firmware/Software Update

If you need to update the software of your LANTIME, you need a specific update file. You can download the latest LANTIME firmware version from our website: <https://www.meinbergglobal.com/english/sw/firmware.htm>

The update file can be uploaded to the LANTIME by first choosing the file on your local computer with the "Browse" button and then press "Start Update". Afterwards you are prompted to confirm the start of the update process.

Errors may be detected during installation, such as an unusable update package or a missing signature of the update file. For security reasons, some information is displayed during installation. The following is an excerpt of possible warning or info messages:

```

An error occured while checking update file - Update aborted.
Running Preflight Checks
Checking digital signature of file ...
WARNING: Could not verify digital signature of update file: Error: invalid file format/type.

WARNING: This file does not seem to have been digitally signed, please double check that it is a valid
update file and has not been corrupted/modified.

INFO: Version information in update file: 6.24.21.
OK: Installation file is readable.
INFO: This is a release file, image version is 6.24.21
OK: Update file is suitable for this system [x86].

ERROR: This update does not provide the following required features: cq7atom_support

```

This example shows the attempt to install an update package that does not support the CPU's Q7 processor.

LANTIME - Updates for Reference Clocks and HPS Modules

Please be advised that "*Refclock Updates*" and "*HPS100 Firmware Updates*" can only be installed on systems with the LANTIME operating system LTOS Version 6.24.013 or higher. The latest Firmware Update packages are available at the following link: <https://www.meinbergglobal.com/english/sw/refclock-updates.htm>

Note: No new firmware revision number will be displayed under Firmware Management after a module update is installed. Refclock and HPS100 updates are enabled immediately after a reboot.

9.1.8.13 Download Diagnostic File

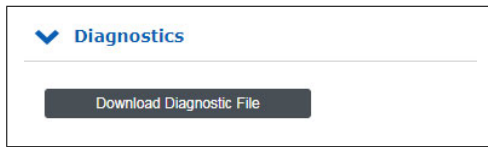

A diagnostic file which includes all status data of a LANTIME system logged since the last reboot can be downloaded from all LANTIME servers. The file format of the diagnostic file is a tgz-archive. The archive contains all the important configuration and logfiles. In most support cases it is the first action to ask the user to download the diagnostic file, because it is very helpful to identify the current state of the LANTIME and to find possible errors.

9.1.8.14 Configuration and Firmware Management

Configuration & Firmware Management

Configuration Management

Save Current Configuration As:

Upload Configuration:
 Keine ausgewählt

| Available Configurations | Options | | |
|---------------------------|---|---------------------------------------|---|
| startup | <input type="button" value="Activate"/> | <input type="button" value="Delete"/> | <input type="button" value="Download"/> |
| preupdate | <input type="button" value="Activate"/> | <input type="button" value="Delete"/> | <input type="button" value="Download"/> |
| lt_backup_config_N_A_greg | <input type="button" value="Activate"/> | <input type="button" value="Delete"/> | <input type="button" value="Download"/> |

Firmware Management

Running Firmware
7.00.045-testing

Scheduled Firmware
7.00.045-testing

| Available Firmware Files | Version | Type | Options | |
|--------------------------------|----------|---------|---|---------------------------------------|
| OSV (Original Shipped Version) | 6.25.181 | testing | <input type="button" value="Activate"/> | <input type="button" value="Delete"/> |
| fw_7.00.027-testing | 7.00.027 | testing | <input type="button" value="Activate"/> | <input type="button" value="Delete"/> |
| fw_7.00.037-testing | 7.00.037 | testing | <input type="button" value="Activate"/> | <input type="button" value="Delete"/> |
| fw_7.00.045-testing | 7.00.045 | testing | <input type="button" value="Activate"/> | <input type="button" value="Delete"/> |

With this menu you can save different configuration files for backup on the flash memory of the LANTIME. By using the "Activate" button a stored configuration can be loaded, the "Delete" button can be used to delete a configuration file and the "Download" button in order to download a file.

Additionally more than one Firmware version can be archived on the LANTIME. If an updated version is not corresponding correctly in the environment, then it is possible to reactivate one of the established versions again on the LANTIME.

Remove unneeded Versions

| Available Firmware Files | Version | Type | Options | |
|--------------------------------|----------|---------|---|---------------------------------------|
| OSV (Original Shipped Version) | 6.25.181 | testing | <input type="button" value="Activate"/> | <input type="button" value="Delete"/> |
| fw_7.00.218-testing | 7.00.218 | testing | <input type="button" value="Activate"/> | <input type="button" value="Delete"/> |
| fw_7.00.220-testing | 7.00.220 | testing | <input type="button" value="Activate"/> | <input type="button" value="Delete"/> |

With this button all unused firmware versions can be deleted. Only the active firmware and the OSV (Original Shipped Version) remain on the system.

LANTIME Updates for reference clocks and HPS modules

Note: No new firmware revision number will be displayed under Firmware Management after a module update is installed. Refclock and HPS100 updates are enabled immediately after a reboot.

9.1.8.15 Display

Display

Front Panel Light Enabled

Time Zone

[Edit Time Zone Table](#)

Front Panel Light Enabled:

Through this checkbox the front panel display light can be switched on permanently.

Time Zone:

Time Zone setting for the front panel display of the LANTIME and the time which is shown in the "Date/Time" section of the Main page in the web interface. Note: This setting does not affect the time which is provided by the LANTIME through NTP, PTP, serial time strings or IRIG.

Exception:

In the case NTP is configured to provide local time instead of UTC you need to configure the exact local time zone here in the display time zone setting. This setting is then used for NTP as well.

Edit Time Zone Table:

The button "Edit Time Zone Table" can be used to add new timezone definitions.

Edit time zone information table:

```
(UTC-10) - HST/HDT,HDT,0,08.03.****,-,09:00,02:00:00,HST,0,01.11.****,-,10:00,02:00:00
(UTC-9) - AST/ADT,ADT,0,08.03.****,-,08:00,02:00:00,AST,0,01.11.****,-,09:00,02:00:00
(UTC-8) - PST/PDT,PDT,0,08.03.****,-,07:00,02:00:00,PST,0,01.11.****,-,08:00,02:00:00
(UTC-7) - MST/MDT,MDT,0,08.03.****,-,06:00,02:00:00,MST,0,01.11.****,-,07:00,02:00:00
(UTC-6) - CST/CDT,CDT,0,08.03.****,-,05:00,02:00:00,CST,0,01.11.****,-,06:00,02:00:00
(UTC-5) - EST/EDT,EDT,0,08.03.****,-,04:00,02:00:00,EST,0,01.11.****,-,05:00,02:00:00
(UTC) - UTC,UTC,0,01.01.****,+00:00,00:00:00,UTC,0,01.01.****,+00:00,00:00:00
(UTC) - WET/WEST,WEST,0,25.03.****,+01:00,01:00:00,WET,0,25.10.****,+00:00,02:00:00
(UTC+1) - CET/CEST,CEST,0,25.03.****,+02:00,02:00:00,CET,0,25.10.****,+01:00,03:00:00
(UTC+2) - EET/EEST,EEST,0,25.03.****,+03:00,03:00:00,EET,0,25.10.****,+02:00,04:00:00
(UTC+3) - MSK/MSD,MSD,0,25.03.****,+03:00,02:00:00,MSK,0,25.10.****,+03:00,03:00:00
(UTC+3) - UTC3,UTC3,0,01.01.****,+03:00,00:00:00,UTC,0,01.01.****,+03:00,00:00:00
(UTC+4) - UTC4,UTC4,0,01.01.****,+04:00,00:00:00,UTC4,0,01.01.****,+04:00,00:00:00
(UTC+8) - CNST,CNST,0,01.01.****,+08:00,00:00:00,CNST,0,01.01.****,+08:00,00:00:00
(UTC+9) - AWDT,AWDT,0,01.01.****,+09:00,00:00:00,AWDT,0,01.01.****,+09:00,00:00:00
(UTC+10) - ACDT,ACDT,0,01.01.****,+10:00,00:00:00,ACDT,0,01.01.****,+10:00,00:00:00
```

Example:

```
(UTC+1) - CET/CEST,CEST,0,25.03.***,+,02:00,02:00:00,CET,0,25.10.***,+,01:00,03:00:00
```

The string above is the time zone definition for middle Europe. If you require a new time zone setting, this needs to be configured in the same format. The string contains different information, each information is separated by a comma. A detailed description of different string parts shown by an example of the time zone setting for middle Europe is as follows:

1. Field: Display name of the time zone. This name is shown in the list of available time zones → (UTC+1) - CET/CEST
2. Field: Abbreviation of time zone with daylight saving (max 4 letter) → CEST
3. Field: Day of week of changeover to daylight saving time → 0 (Sunday)
4. Field: Date of changeover to daylight saving time (dd.mm.****) → 25.03.*** (Changeover will take place at the first Sunday starting from 25.03.)
5. Field: Sign (+ or -) Add or subtract offset from UTC → +
6. Field: UTC Offset daylight saving (hh:mm) → 02:00
7. Field: Time of changeover → 02:00
8. Field: Abbreviation of standard time zone → CET
9. Field: Day of week of changeover to standard time → 0 (Sunday)
10. Field: Date of changeover to standard time (dd.mm.****) → 25.10.*** (Changeover to standard time will take place at the first Sunday starting from 25.10.)
11. Field: Sign (+ or -) Add or subtract offset from UTC → +
12. Field: UTC offset (hh:mm) → 01:00
13. Field: Time of changeover → 03:00

9.1.8.16 Fan Control

These parameters are only available on LANTIME IMS devices with a built-in fan module.

▼ Fan Control

| | |
|---|--|
| <p>Control Mode</p> <input style="width: 90%;" type="text" value="Automatically"/> | <p>Temperature Threshold (°C)</p> <input style="width: 90%;" type="text" value="55"/> |
| <p>Status Fan 1</p> <input style="width: 90%;" type="text" value="Not connected"/> | <p>Status Fan 2</p> <input style="width: 90%;" type="text" value="Not connected"/> |
| <p>Current Temperature (°C/°F)</p> <input style="width: 90%;" type="text" value="60/140"/> | |

- Control Mode:** Setting of the operating mode. The following options are available:
- Automatically:** With this mode, the fans switch on automatically as soon as the current system temperature exceeds the configured temperature threshold.
- On: In this mode the fans run permanently.
Off: In this mode the fans are permanently turned off .
- Temperature Threshold (C°):** Specification of the system temperature threshold in degrees Celsius. The configured temperature value is taken into account for control of fans when the fan mode "Automatically" is selected.
- Status Fan 1:** Status display of the 1st fan.
Status Fan 2: Status display of the 2nd fan.
- Current Temperature (°/°F):** Displaying the current temperature in degrees Celsius and Fahrenheit.

9.1.8.17 Redundant Power Supply

If your LANTIME is an IMS system, all available power supplies and power consumer are displayed and evaluated in this submenu.

Redundant Power Supply

| | |
|---------------------------------|------------------------------------|
| Status PWR 1 | Status PWR 2 |
| <input type="text" value="OK"/> | <input type="text" value="OK"/> |
| Status PWR 3 | Status PWR 4 |
| <input type="text" value="OK"/> | <input type="text" value="Error"/> |

Power Consumption Info

| | |
|------------------------|---|
| Number Power Supplies: | 3/4 (Max Power: 150W) |
| Available Power: | 150.0W [+ redundant Power Supplie(s)] |
| Current Power: | 45.8W |
| Redundancy: | Available |
| Overloading: | No |
| Number Consumer: | 12 |

Consumer Load

| | |
|----------------------|------|
| Backplane: | 0.7W |
| Power Supplies: | 4.5W |
| Display: | 1.2W |
| FCU: | 0.3W |
| GPS180 with OCXO-HQ: | 7.8W |
| RSC180: | 2.9W |
| GNS181 with OCXO-HQ: | 6.8W |
| QA31: | 3.5W |
| PTPv2 TSU: | 5.0W |
| HPS100: | 6.0W |
| ES1180: | 1.1W |
| HPS100: | 6.0W |

Power Consumption Info

The available power depends on the number of used power supply units. In the example we have three power supply units, each with 50W of power - this results in a total of 150W when all power supply units are in active state.

As long as, as in this example, a value below 50W is displayed in the field "Current Power", only one power supply is sufficient to supply this system. If the value is greater than or equal to 50W, two power supply units are required for supply or three active power supply units are required to ensure redundancy.

The "Redundancy" field is set to "Available" if the "Available Power" minus the "Current Power" is greater than or equal to 50W. The "Overload" field always displays "No" as long as the "Current Power" is less than or equal to "Available Power".

Consumer Load

This table lists all consumers of the system. The backplane, the CPU, the power supplies, the receivers and all other modules used. The sum of all consumers gives the value that is displayed as Current Power.

9.1.9 Statistics

LANTIME - Statistics

- [NTP Performance Graph](#)
- [PTP V2 Statistics](#)
- [NTP Status](#)
- [NTP Monlist](#)
- [NTP Debug](#)
- [NTP Client List](#)

Save Settings
Reset Changes
Back

9.1.9.1 NTP Performance Graph

In the submenu NTP performance graph, the NTP statistics (loopstats) are displayed in the form of a graph.

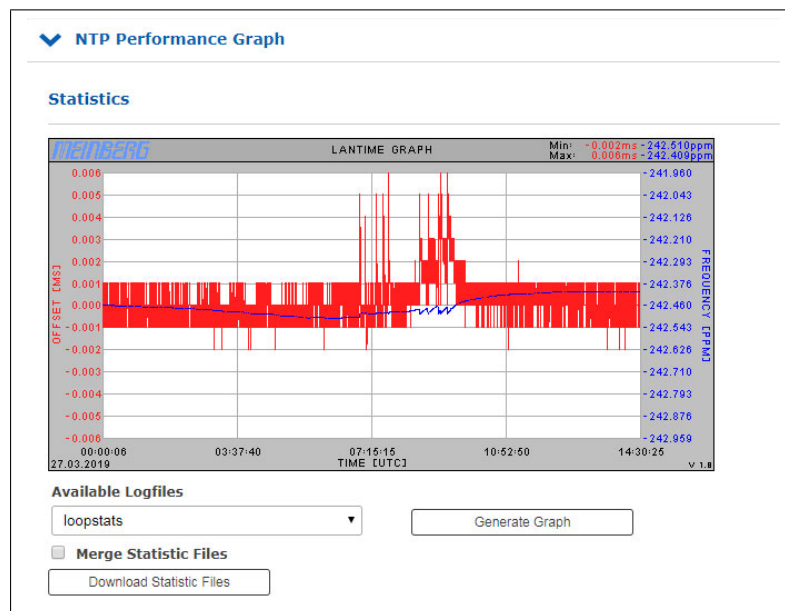

The red lines and the primary Y-axis represent the offset between the system time and the NTP reference time source (in ms). The blue line and the secondary Y-axis, on the other hand, illustrate the frequency adjustment of the oscillator which is built on the CPU by the ntpd (in PPM), to adjust the system time to the reference time source.

The minimum and maximum measured value of the frequency deviation and offsets can be read in the upper right corner.

Available Log Files:

You can select the available log data via the dropdown menu. The ntpd creates a new loopstats file for each day.

Merge Statistic Files:

After activating the checkbox and clicking on "Generate Graph", all available log files are merged and displayed as one graph.

9.1.9.2 PTP V2 Statistics

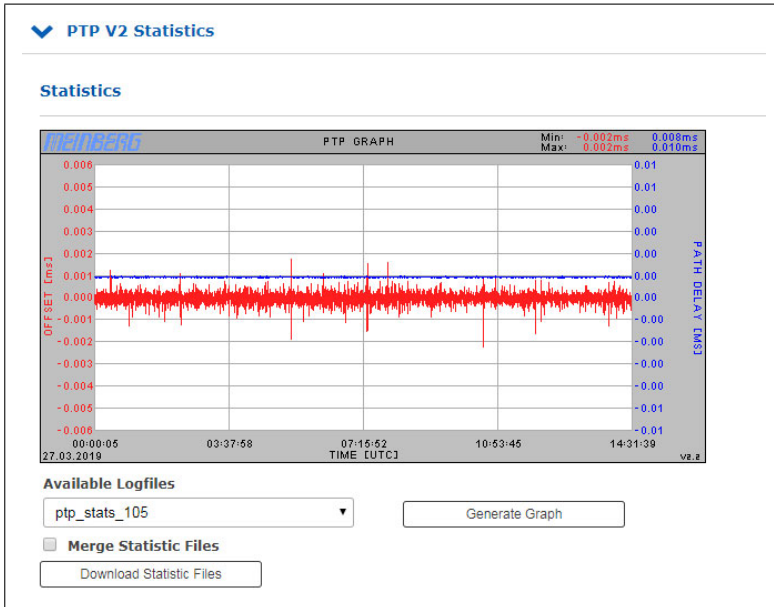

This graphic is only available if the LANTIME is equipped with a PTP module, which is configured as PTP SLAVE.

The red line shows the time offset between the time of the built-in reference clock and the incoming PTP signal (in micro s). The blue line shows the path delay determined by the PTP module.

9.1.9.3 NTP Status

This menu lists the current states of all reference time sources (peers) available to the NTP service. For integrated reference clocks as well as normal external NTPv4 servers, this corresponds to the output of the command `"ntpq -p"`. For external NTS servers, this display also includes status information from a Chrony time service, in which case there may be minor differences in how the information is displayed.

The following example shows the NTP status output of a LANTIME with an integrated GNSS reference clock and two external NTP time servers configured:

| NTP Status | | | | | | | | | | |
|--------------|-------------|-------|---------|------|------|------|-------|-------|--------|--------|
| Remote IP | Remote Host | RefID | Stratum | Type | When | Poll | Reach | Delay | Offset | Jitter |
| o127.127.8.0 | GENERIC(0) | .MRS. | 0 | l | 3 | 8 | 377 | 0.000 | -0.001 | 0.001 |

Remote IP:

IP address of the NTP peer. Alternatively, if it is a hardware time reference (e.g., a radio clock or a GPS receiver), this will show 127.127.x.x.

Codes may be displayed alongside each of the NTP peer IP addresses. These have the following meanings:

| | |
|-----|--|
| '*' | This server has been selected for synchronization. |
| 'o' | The system is synchronized on the basis of a pulse-per-second (PPS) signal, either indirectly via the PPS reference clock driver or directly via a kernel interface. |
| '+' | The peer is a candidate for synchronization. |
| '-' | The server is not suitable for synchronization. |
| 'x' | The server is detected as a <i>falseticker</i> and is not suitable for synchronization. |
| '#' | The server is a survivor, but not among the first six servers. |
| ' ' | The peer is rejected due to being unreachable or is itself synchronized by this server (sync loop). |

Remote Host:

The resolved DNS name of the NTP peer or, for NTS servers, the address of the associated NTS-KE server.

RefID:

The time reference of the NTP peer.

Stratum:

Stratum value of the NTP peer.

Type:

(Type of the NTP Peer)

| | |
|----|------------------------|
| l: | Local reference clock |
| b: | Broadcast or multicast |
| u: | Unicast |
| s: | Symmetric peer |
| a: | Manycast |
| c: | NTS server |

When:

Value in seconds. Indicates when the NTP peer was last queried.

Poll:

Interval in seconds. Specifies the time between queries to the NTP peer.

Reach:

Octal value. Indicates the status of the last 8 queries. The value "377" (binary value 11111111) means that the last eight queries were successful.

Delay:

Value in ms. Displays the transmission time of the NTP packet.

Offset:

The NTP software compares its own system time with its reference time sources at regular intervals, a process that is referred to as "polling". After each polling operation, the packet round trip time is determined, calculated, and the current time difference ("offset") is calculated and displayed in milliseconds.

Jitter:

The packet round trip time will vary depending on network conditions when "polling" external NTP sources upon each time comparison, and so the calculated time offset will also vary. Because of this, the results of multiple successive time comparisons are filtered by calculating weighted mean values for packet transmission time and time offset. Variations in the individual values relative to these mean values are referred to as "jitter"; the higher the jitter value, the less accurate the calculated time offset is likely to be. On the other hand, if the mean time offset gradually rises, this is indicative of the system time drifting away from the reference time. The value is displayed in milliseconds.

9.1.9.4 NTP Monlist

The submenu "NTP Monlist" lists all NTP clients which have queried the LANTIME time via NTP. The list is created and displayed using the NTP Query Tool. The following ntpq command is issued: ntpq -c mrulist

More information about the NTP Query Tool can be found in the NTP documentation at <http://doc.ntp.org/current-stable/ntpq.html>

| NTP Monlist | | | | | | | | | |
|-------------|--------------|------|---|---|---|-------|-------|----------------|--|
| Last | Avg Interval | Rstr | R | M | V | Count | Rport | Remote Address | |
| 2 | 2 | 0 | . | 3 | 4 | 10981 | 36802 | 169.254.107.2 | |

Last:

Time in seconds. Specifies when the client requested the time from the LANTIME.

Avg Interval:

Interval: Average time in seconds between two NTP requests.

Rstr:

Shows if there are active Restrict Flags for this remote IP.

R:

Indicates whether the "Rate Control" is active or not.

M:

NTP package identification

0 → reserved

1 → symmetric active

2 → symmetric passive

3 → client

4 → server

5 → broadcast

6 → NTP control message

7 → reserved

V:

NTP Version

Count:

Number of packets received from the remote address

Rport:

"Source Port" of the last received packet

Remote Address:

IP Address of the requesting device

9.1.9.5 NTP Debug

▼ NTP Debug

| Index | assID | Status | Conf | Reach | Auth | Condition | Last Event | Count |
|-------|-------|--------|------|-------|------|-----------|------------|-------|
| 1 | 30334 | 9714 | yes | yes | none | pps.peer | reachable | 1 |
| 2 | 30335 | c811 | yes | none | yes | reject | mobilize | 1 |

assID: 0 Sysvars

assID: 30334 Clockvars Readvars

Variable/Value

```

associd=30334 status=0000 no events, clk_unspec,
device="Meinberg GPS receiver",
timecode="\x0210.04.19; 3; 14:57:47; +02:00; S ; 51.9823N 9.2259E 166m\x03",
poll=23953, noreply=0, badformat=0, baddata=0, fudgetime1=4.500,
stratum=0, refid=MRS, flags=1,
refclock_ppstime="e05866ca.ffffff7f Wed, Apr 10 2019 12:57:47.000",
refclock_time="e05866cb.00000000 Wed, Apr 10 2019 12:57:47.000",
refclock_status="TIME CODE; PPS; POSITION; (LEAP INDICATION; PPS SIGNAL; POSITION)",
refclock_format="Meinberg GPS Extended",
refclock_states=""NOMINAL: 2d+05:13:40 (100.00%); running time: 2d+05:13:40"
                    
```

assID: 30335 Clockvars Readvars

The NTP Debug submenu displays NTP debug information queried by the LANTIME using the NTP Query Tool (ntpq). The "ntpq" is executed with the following parameters:

- "clockvar"
- "associations"
- "readvar"

More information about the query tool can be found in the NTP documentation at <http://doc.ntp.org/current-stable/ntpq.html>

9.1.9.6 NTP Client List

In addition to the native NTP logging functions, the LANTIME offers the possibility to maintain a list of all NTP clients. The function is switched off by default, and can be activated if desired.

▼ NTP Client List

Activate Logging

Duration of Recording

Log Level

Available Logfiles

Date of Recording: 201
Total duration=01d, 11h, 59m, 12s

Started at=2019-09-18 12:00:48 (UTC)
Logfile duration=01d, 00h, 00m, 00s

Today's clients=7
Today's requests=94001

Total clients=14 This value is obsolete and should no longer be used.
Total requests=140240

| NTP Client | Requests | Options |
|----------------|----------|---------|
| 172.27.100.12 | 521 | |
| 172.27.100.32 | 23511 | |
| 172.27.100.57 | 22906 | |
| 172.27.100.70 | 2659 | |
| 172.27.100.148 | 23801 | |
| 172.27.101.238 | 10131 | |
| 172.27.101.254 | 10472 | |

Activate Logging:

Activates the feature on the LANTIME.

Duration of Recording:

The duration for which the LANTIME maintains the client list. When configuring continuous recording, old daily statistics are automatically cleared after a few days in order to save space.

Log Level:

Determines which version of the IP protocol is taken into account. Available are IPv4, IPv6 or both versions in combination.

Available Log Files:

If the client logging is activated, log files for display are provided at this point. Select the desired daily statistics from the selection box and use the "Show" button to display the statistics. You will then receive a list of clients as well as other statistics.

| NTP Client | Anfragen | Optionen |
|----------------|----------|-------------------------|
| 172.16.100.172 | 1214 | Details |
| 172.27.101.162 | 569 | Details |

A click on Details will now also show you detailed information about the received NTP packets of a particular client.

- Columns 0-23 indicate the hour of the day.
- The 3 additional lines provide information on whether the received NTP packet had mode 3, 4, or another. Modus 3, 4 oder einen anderen hatte.
- Modus 3 → Client
- Modus 4 → Server

9.1.10 Clock

On this page of the web interface, configurations can be made on the respective installed reference clocks or the changeover card.

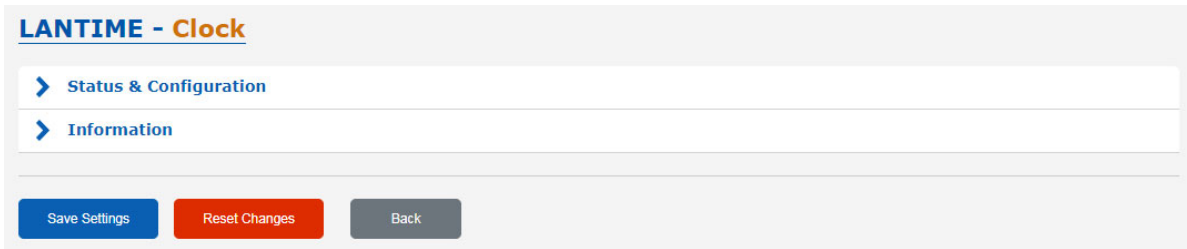

Depending on the design of the system, which means whether it is a single reference clock or a system with two installed remote clocks and a changeover card, the web interface builds up accordingly. This also applies to the type of reference clock and its options. In case of a redundant receiver configuration the common settings for "IRIG In/Out", "Serial Ports", "Time Zone", "Enable Outputs", "Programmable Pulses" and "Synthesizers" appears into the "Switch Card" menu.

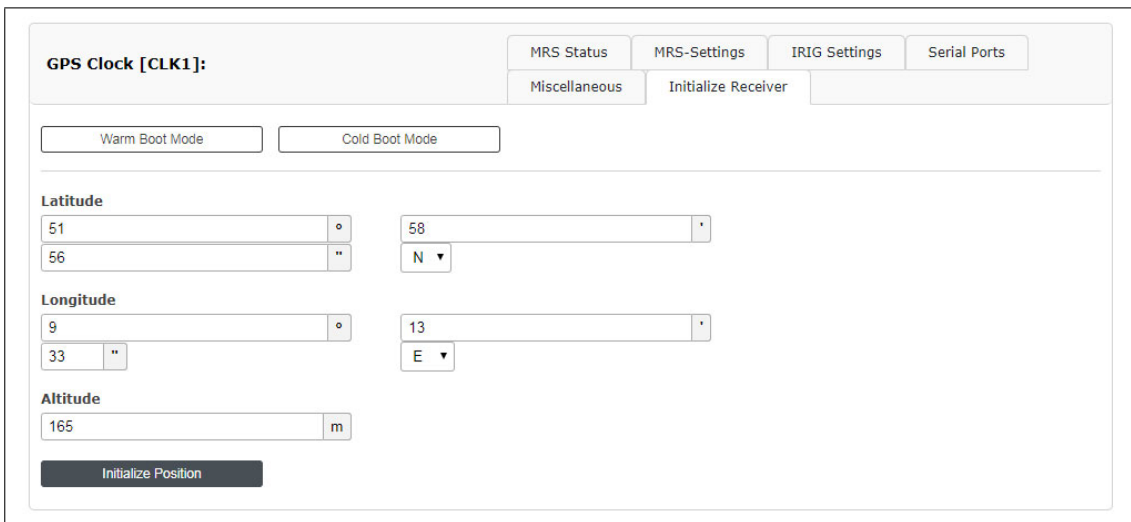

Figure: Menu "Clock" in case of a single receiver

9.1.10.1 MRS Status

Here the states of the reference inputs are shown:

| | | | |
|--------------------|--|---|--|
| Priority: | Arrangement of the time source according to your prioritization. | | |
| Source: | Type of reference source. | | |
| Status: | No Connection, No signal | → | the reference source is not available. |
| | Signal available | → | the reference source is available. |
| | Is master | → | the reference source is used to synchronize the system. |
| | Is locked | → | the system synchronizes itself to the reference source. |
| | Is accurate | → | Basic accuracy of synchronization reached. |
| Offset: | Time difference of the reference clock to the specified time source. | | |
| Statistics: | Span | → | If the difference between the min / max value of the time source is over a defined statistical interval. |
| | Step-Compensation | → | Displays a hard time jump of the reference source (currently only available for PTP). |
| | Auto-Bias | → | Time offset determined for the source versus an offset-free time source. |

▼ State & Configuration

GPS Clock [CLK1 - Sync to GPS]:

MRS State
MRS Settings
IRIG Settings
Serial Ports

Miscellaneous
Initialize Receiver

| Priority | Source | State | Offset | Statistics |
|----------|--|--|--------|---------------|
| 01 | GPS | Signal available, Is master, Warmed up, Is locked, Is accurate | +4.0ns | |
| 02 | PPS in (Chassis 0, Slot ESI1, Instance 0) | No connection, No signal | N/A | Not available |
| 03 | 10 MHz (Chassis 0, Slot ESI1, Instance 0) | Signal available | +0.0ns | |
| - | NTP | Not prioritized | N/A | |
| - | PTP (IEEE1588) | Not prioritized | N/A | |
| - | PPS plus string | Not prioritized | N/A | |
| - | 2048 kHz (Chassis 0, Slot ESI1, Instance 1) | Not prioritized | N/A | |
| - | E1 framed (Chassis 0, Slot ESI1, Instance 2) | Not prioritized | N/A | |

Figure: An example of available reference signals in the priority order.

The table below shows the possible reference sources - the availability depends on the hardware configuration of the system.

| Signal | provided by |
|--|--|
| GPS | built-in GPS receiver |
| GNSS | built-in GNS receiver |
| PPS plus string | external signal generator |
| NTP | external NTP Server |
| PTP (IEEE1588) SyncE | HPS / TSU Time Stamp Module HPS Time Stamp Module |
| E1 framed PPS In Fixed Freq. | IMS ESI - Input module for 2.048 MHz, 2.048 MBit/s, 1PPS and variable frequencies |
| IRIG PPS in 10 MHz | IMS MRI - IRIG, 1PPS, 10 MHz input module |
| Video In LTC In Freq. In PPS In | IMS VSI - Video Signal Input Module |

9.1.10.2 MRS Settings

The MRS stands for a Multi Reference Source clock. This is a special functionality of a receiver that can in addition to GNSS use also other input signals as a reference for synchronization.

9.1.10.3 MRS Source Priority

In the MRS Settings you can configure a priority list of input signals how the switching will follow in case that a master reference becomes unavailable. The selection of signals in the list is automatically generated by the LANTIME according to the hardware configuration. The priority list of input signals should be configured in a descending order referring to the accuracy of signals.

Here is an example how to configure a priority list in a descending order:

1. Source: GNSS / GPS
2. PPS + String
3. PTP – IEEE1588
4. external NTP Server

The screenshot displays the 'Status & Configuration' page for the 'GPS Clock [CLK1 - Sync to GPS]'. The 'MRS-Settings' tab is selected. Under the 'Source Priority' section, the following configuration is shown:

| Priority | Source |
|-----------|----------------------|
| 1. Source | GPS |
| 2. Source | PPS in |
| 3. Source | IRIG |
| 4. Source | Fixed Freq. in |
| 5. Source | PTP (IEEE1588) |
| 6. Source | PPS plus string |
| 7. Source | --- Unconfigured --- |
| 8. Source | --- Unconfigured --- |

Figure: Configuration example of reference signals in a descending order.

PTP as reference signal

LANTIME - Clock

▼ Status & Configuration

GLN Clock [CLK1 - Sync to PTP]:

MRS Status MRS-Settings IRIG Settings Serial Ports Programmable Pulses Synthesizer Time Zone

Enable Outputs Miscellaneous Initialize Receiver

| Priority | Source | Status | Offset | Statistics |
|----------|------------------------|---|---------|------------|
| 01 | GNSS Receiver | No connection, No signal | N/A | |
| 02 | PPS plus string | No connection, No signal | N/A | |
| 03 | PTP (IEEE1588) [IO1] 4 | Signal available, Is master, Is locked, Is accurate | -26.0ns | |
| 04 | NTP | No connection, No signal | N/A | |

Figure: IMS-HPS100 on IO1 as PTP reference

HPS modules (with FW $\geq 1.4.1$) can operate in all I/O slots as PTP master or slave

An IMS-HPS100 module can be used in slave mode on all slots (MRI, ESI and I/O) of an IMS system. This allows it to act as a high-precision PTP reference input for the system (see figure).

A slave is selected by the BMCA procedure (Best Master Clock Algorithm) if more than one HPS100 module is used in a system and in slave mode, which is then listed in the MRS priority list (see figure). As the master-reference, this slave sends its correction data to the clocks installed in the system (CLK1 and CLK2).

Information:



This function is only possible with the HPS100. The TSU GbE does not support this function.

In case of a redundant receiver configuration and the installation of the HPS100 in an ESI/MRI slot, the master/slave mode only works for the assigned clock. If the receiver CLK1 is to be synchronized via an HPS100, then this must either be in an IO slot or installed in the MRI1/ESI1 slot.

9.1.10.4 IRSA - Intelligent Reference Selection Algorithm

IRSA stands for an Intelligent Reference Selection Algorithm. In case that a master signal fails the IRSA takes care that the switching to the next reference signal in the priority list runs automatically and smoothly. The IRSA also takes into account the highly stable holdover performance of the local oscillator. It ensures that switching from the superior reference signal to the less accurate one is delayed as long as the highly stable oscillator can provide better accuracy in holdover than the next available reference signal in the priority list.

IRSA - Intelligent Reference Selection Algorithm

Precision | Advanced Source Selection | Extended Options

Fixed Offset & Limit

Activate IRSA

| GPS | NTP | PTP (IEEE1588) |
|--|---|---|
| 0 ns | 999999999 ns | 0 ns |
| SYNCE [MRI1] 0 ns | PPS plus string 0 ns | PPS in (Chassis 0, Slot ESI1, Instance 0) 0 ns |
| 10 MHz (Chassis 0, Slot ESI1, Instance 0) 0 ns | 2048 kHz (Chassis 0, Slot ESI1, Instance 1) 0 ns | |
| E1 framed (Chassis 0, Slot ESI1, Instance 2) 0 ns | | |

Load Defaults

Figure: Activated IRSA mode with estimated precision values for available references.

To ensure that IRSA is working properly, follow these steps:

1. Configure a priority list of available reference signals in descending order from the superior to inferior one in the MRS Settings menu (see chapter [MRS Source Priority](#)).
2. Activate IRSA in the IRSA menu. As per default the IRSA is deactivated.
3. Fill in the estimated precision values for the input reference signals in for this provided "Precision" column. According to the estimated precision values the holdover time between current source and the next source from the priority list will be calculated.

Here are some estimated precision values which you can load as defaults:

- GPS / GNSS as the first priority has the highest estimated precision :100 ns
- ext. Osc. (e.g. Rubidium): 120 ns
- PTP IEEE 1588: 100 ns
- PPS plus string: 100 ns
- NTP: 100 us

9.1.10.5 MRS Features

Advanced Source Selection

A firmware V6.24 and the following versions support a mixed combination of reference signals for synchronization. In the mixed mode you can select one source only for the ToD (Time of Day) synchronization and another source for phase and frequency. The phase and frequency can be provided by a highly stable and accurate source, for example an atomic clock, like Rubidium or Cesium.

The Time of Day (ToD) information represents a “wall clock time” – a specific time with hours, minutes, seconds and the corresponding date. The ToD information cannot be delivered by an atomic clock alone. Therefore, if you need the ToD in your system, you need to select one of the reference signal which includes the ToD information, for example GPS, NTP, PTP, PPS plus string.

If you use the mixed mode the reference clock will be steered first by a reference signal which includes the ToD. The oscillator will be roughly adjusted until it reaches the highest level of accuracy that can be achieved by this reference. After that the reference clock switches automatically to a more accurate source, for example a 1PPS coming from an external atomic clock that provides highly stable phase or a 10MHz signal to provide a stable frequency.

As per default both ToD and Phase are enabled for each available reference source. If you want to use the mixed mode, then select the ToD for one reference signal and phase for another. The reference sources you wish to use should be configured first in the Source Priority list. See MRS Settings → [MRS Source Priority](#).

Here is one configuration example for Advanced Source Selection:

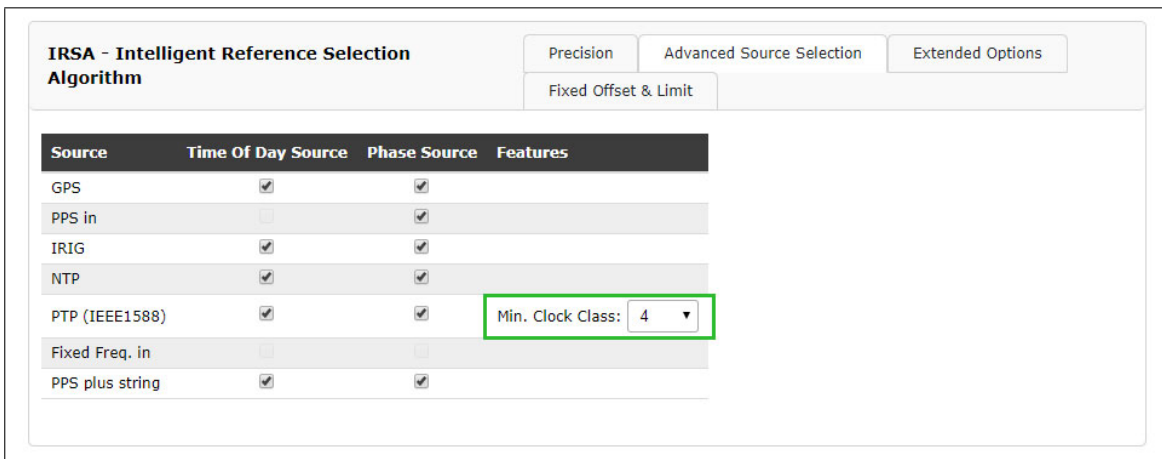

Figure: An example for a mixed combination of ToD and Phase source for given reference signals.

PTP Min. Clock Class

The MRS system should only use a PTP master to synchronize the clock if the desired clock class is given. It should be prevented that the slave remains synchronized to a bad master, although another source is available.

9.1.10.6 Extended Options

The Trusted Source (TRS) feature is a powerful tool to protect the GNSS¹ receiver from spoofing attacks. For the moment, the Trusted Source feature is supported only in combination with a Meinberg GPS or GNSS receiver and a Meinberg XHE external Rubidium holdover unit.

To activate this feature, select "Use Trusted Source" check box for the GPS reference signal. It means that GPS reference will be checked for consistency by another reference source which is acknowledged as a Trusted Source. In our case the trusted source is a Rubidium atomic clock. It is denoted as ext.Osc. (external oscillator) in the table of Extended Options. Therefore select this check box "Is Trusted Source".

| IRSA - Intelligent Reference Selection Algorithm | | | | | | | |
|--|--------------------------|---------------------------|--------------------------|--------------------------|--------------------------|--------------------------|--|
| | Precision | Advanced Source Selection | Extended Options | Fixed Offset & Limit | | | |
| Source | Auto Bias Master | Auto Bias Slave | Is Trusted Source | Use Trusted Source | Asymmetry Step Detection | Measurement only | |
| NTP | <input type="checkbox"/> | <input type="checkbox"/> | <input type="checkbox"/> | <input type="checkbox"/> | <input type="checkbox"/> | <input type="checkbox"/> | |
| PTP (IEEE1588) | <input type="checkbox"/> | <input type="checkbox"/> | <input type="checkbox"/> | <input type="checkbox"/> | <input type="checkbox"/> | <input type="checkbox"/> | |
| PPS plus string | <input type="checkbox"/> | <input type="checkbox"/> | <input type="checkbox"/> | <input type="checkbox"/> | <input type="checkbox"/> | <input type="checkbox"/> | |
| GNSS Receiver | <input type="checkbox"/> | <input type="checkbox"/> | <input type="checkbox"/> | <input type="checkbox"/> | <input type="checkbox"/> | <input type="checkbox"/> | |
| PPS in (Chassis 0, Slot ESI1, Instance 0) | <input type="checkbox"/> | <input type="checkbox"/> | <input type="checkbox"/> | <input type="checkbox"/> | <input type="checkbox"/> | <input type="checkbox"/> | |
| 10 MHz (Chassis 0, Slot ESI1, Instance 0) | <input type="checkbox"/> | <input type="checkbox"/> | <input type="checkbox"/> | <input type="checkbox"/> | <input type="checkbox"/> | <input type="checkbox"/> | |
| 2048 kHz (Chassis 0, Slot ESI1, Instance 1) | <input type="checkbox"/> | <input type="checkbox"/> | <input type="checkbox"/> | <input type="checkbox"/> | <input type="checkbox"/> | <input type="checkbox"/> | |
| E1 framed (Chassis 0, Slot ESI1, Instance 2) | <input type="checkbox"/> | <input type="checkbox"/> | <input type="checkbox"/> | <input type="checkbox"/> | <input type="checkbox"/> | <input type="checkbox"/> | |
| Video In (Chassis 0, Slot MRI1, Instance 0) | <input type="checkbox"/> | <input type="checkbox"/> | <input type="checkbox"/> | <input type="checkbox"/> | <input type="checkbox"/> | <input type="checkbox"/> | |
| LTC In (Chassis 0, Slot MRI1, Instance 1) | <input type="checkbox"/> | <input type="checkbox"/> | <input type="checkbox"/> | <input type="checkbox"/> | <input type="checkbox"/> | <input type="checkbox"/> | |
| Freq. In (Chassis 0, Slot MRI1, Instance 2) | <input type="checkbox"/> | <input type="checkbox"/> | <input type="checkbox"/> | <input type="checkbox"/> | <input type="checkbox"/> | <input type="checkbox"/> | |
| PPS in (Chassis 0, Slot MRI1, Instance 0) | <input type="checkbox"/> | <input type="checkbox"/> | <input type="checkbox"/> | <input type="checkbox"/> | <input type="checkbox"/> | <input type="checkbox"/> | |

Figure: An example of a Trusted Source mode of operation with an external rubidium.

The external Rubidium acts as an external oscillator that is synchronized by the GPS or GNSS Master as long as the master is available and its precision is better than the precision of the XHE. If the Master fails or for some reason uses corrupted or manipulated data the TRS will detect this as an offset limit violation. Consequently, the reference selection algorithm will discard the current master and the XHE Rubidium source will become the new master for synchronization.

Both GNSS and Rubidium reference signals need to be configured first in the Source Priority list, GPS or GNSS as "Source 1" and external Oscillator as "Source 2". All other positions should be left empty (see chapter [MRS Source Priority](#)).

Second, the IRSA Reference algorithm should be activated with corresponding precisions (see chapter [IRSA - Intelligent Reference Selection Algorithm](#)).

The precision for GPS or GNSS is at same time also the TRS limit, that the reference should comply with. If the TRS limit is violated the reference selection algorithm discards the current master and switches automatically to the Trusted Source - XHE Rubidium. For the GPS or GNSS precision value we take 250ns which is maximum time deviation allowed for the receiver.

Finally, the GPS or GNSS source should have enabled "Time of Day Source" and "Phase Source", which means that the receiver is a source for both Time of Day and Phase. At the XHE Rubidium only the Phase Source should be enabled, since the atomic clock alone does not deliver the ToD information (see chapter [MRS Features](#)).

Auto Bias Master / Auto Bias Slave

"Auto Bias" provides a technology for a situation where a constant offset which is present with a given input signal can be measured and compensated against a trusted reference automatically. The reasons for this constant offset could be a cable delay which introduces a fix offset (5ns per each m of coax cable and 3ns for fiber), a delay caused by an IRIG generator if IRIG is used as an input, or a constant offset via PTP due to a network or traffic asymmetry.

So, if you choose for example GPS as a reference signal at priority 1 while having "Auto Bias Master" activated for GPS, then GPS will be used as a measurement reference for all other sources as long as GPS is

¹GPS / GNSS: The Trusted Source (TRS) feature will only work with GPS and GNS receivers.

available.

If PTP is configured as a secondary priority with "Auto Bias Slave" activated, the constant offset of the PTP input signal is measured against the current "Auto Bias Master" reference (e.g. GPS) and will be compensated automatically.

Furthermore, even if PTP becomes a reference signal in case that a Master is not available, the PTP offsets will include a compensation for the initial offset measured against the previous Master automatically. In this operating mode a smooth transition from GPS to PTP will be possible without a time step in case GPS becomes unavailable.

If PTP is then a primary sync source and an asymmetry step suddenly occurs in the network (due to path rearrangements e.g.), the occurring asymmetry step will therefore be automatically compensated as well in case "Asymmetry Step Detection" is activated.

Asymmetry Step Detection

When Asymmetry Step Detection is activated, the PTP slave does not follow hard time jumps. The soft synchronization is retained and the time jump is displayed as an offset in the MRS statistics.

With activated "Asymmetry Step Detection", the system measures the offset for approx. 10 minutes. After another 10 minutes, a determined value or offset is set, which is then displayed under MRS -> PTP status [Step Compensated]:

```
Auto-Bias:  0.000000000s
Step-Comp.: -0.000010001s
Span:      0.000000025s
```

Measurement Only

If the field is activated, this source is only used for measurements but never as a synchronisation source.

9.1.10.7 Fixed Offset and Limit

The "Fixed Offsets" and "Limits" can be entered by using the corresponding fields. The "Fixed Offset" specifies a fixed offset for each reference clock to the reference time. With this value, known and constant deviations of a reference time source can be compensated. No constant offset can be set for GNSS references - this can only be done indirectly with the antenna cable compensation time.

Limit:

Here you can configure a limit value. If the reference source exceeds this limit, a notification is triggered. A configuration in the Web Interface is required on the Notification page "Notification → Notofication Event → MRS Limit Exceed".

| Source | Offset | Limit |
|-----------------|--------|-------|
| GPS | 0 ns | 0 ns |
| PPS in | 0 ns | 0 ns |
| IRIG | 0 ns | 0 ns |
| NTP | 0 ns | 0 ns |
| PTP (IEEE1588) | 0 ns | 0 ns |
| Fixed Freq. in | 0 ns | 0 ns |
| PPS plus string | 0 ns | 0 ns |

Figure: Configuration dialog for known offsets and limits.

9.1.10.8 IRIG Settings

▼ State & Configuration

TCR Clock [CLK1 - Sync to TCR]:

MRS State
MRS Settings
IRIG Settings
Serial Ports

Programmable Pulses
Synthesizer
Time Zone

Enable Outputs
Miscellaneous
Initialize Receiver

Input Timecode

IEEE1344

UTC Offset

+ 00 Hours 00 Minutes

UTC offset not required when using IEEE codes.

Utilize TFOM Disabled **Max. TFOM (acceptable)** 0

Output Timecode

B002+B122

Time Scale

UTC

Utilize TFOM Disabled **Max. TFOM (if not sync)** 0

If supported by the system configuration, this menu can be used to configure the incoming and/or outgoing timecodes.

IRIG

Example:

B002/B003

B002 100pps, PWM DC signal, no carrier, BCD time of year

B003 100pps, PWM DC signal, no carrier, BCD time of year, SBS time of day with second of the day (0-86400)

AFNOR NF S87-500

AFNOR NF S87-500 is a standardized French timecode format that is similar to the IRIG code, but additionally contains information such as the day, the day of the month, and the year.

IEEE1344

In addition to a two-digit year, this standard also includes the offset from UTC, the current Daylight Saving Time status, and announcements regarding the start and end of summertime, as well as information about upcoming leap seconds.

Input Timecode:

The correct timecode must be properly set first for the timecode signal from the reference source to be correctly decoded.

UTC Offset:

If a constant time offset relative to UTC is to be applied to the timecode, this offset must be set here to enable the clock to convert the received time to UTC.

IRIG TFOM

If a TCR clock module is installed and the incoming timecode is set to IEEE1344 or C37.118, the TFOM parameters will be enabled and configurable in the "IRIG Settings" tab.

These timecode formats specify support for a 4-bit Time Figure of Merit (TFOM) within the control bits of the format-specific extensions, and this TFOM can be used to communicate to the receiver system information about the expected time accuracy of the reference system.

If the system is in free-run mode, the TFOM can be calculated on the basis of the expected oscillator drift and free-run time. If the system is synchronized with the reference source, the TFOM will be set to 0. If the reference system does not provide any information on the TFOMs, the TFOM will be set to 15 (undefined).

Utilize TFOM:

Enabled TFOM is applied
 Disabled TFOM is ignored

Max. TFOM (acceptable):

If this signal (e.g., a C37.118 timecode) is used as a reference source, the system can be configured via the Web Interface to only have it synchronize with that source if a defined "Max. TFOM" value is given. If the TFOM exceeds this defined value, the reference signal will no longer be accepted as a valid reference source and the system will switch to the next source in the priority list or, if none is available, to free-run mode.

| TFOM | Estimated Time Error (ETE) | TFOM | Estimated Time Error (ETE) |
|------|----------------------------|------|----------------------------|
| 0* | TQ_LOCKED_TO_UTC | 8 | ETE < 10 ms |
| 1 | ETE < 1 ns | 9 | ETE < 100 ms |
| 2 | ETE < 10 ns | 10 | ETE < 1 s |
| 3 | ETE < 100 ns | 11 | ETE < 10 s |
| 4 | ETE < 1 μ s | 12 | ETE < 100 s |
| 5 | ETE < 10 μ s | 13 | ETE < 1000 s |
| 6 | ETE < 100 μ s | 14 | ETE < 10000 s |
| 7 | ETE < 1 ms | 15 | ETE undefined |

Output Timecode:

If the system has a means of outputting timecodes, these parameters can be configured in much the same way as for the input timecodes.

**Information:**

If the system has redundant receivers, this configuration is performed via the RSC menu.

Time Scale:

The selected timecode can be output with UTC or local time. If "LOCAL TIME OF CLOCK" is selected, the output will be adjusted to account for the configured timezone.

Utilize TFOM:

| | |
|----------|---------------------------------|
| Enabled | TFOM enabled |
| Disabled | TFOM disabled (fixed TFOM is 0) |

**Information:**

If the module is in Simulation Mode, the TFOM will automatically be set to 0.

Max. TFOM (if not sync):

If the system also has an IRIG output (e.g., BPE-2000), a "Max. TFOM" can also be configured here to limit the output TFOM. The output signal will continue to be provided, but the TFOM integrated into the IRIG code will not be increased beyond this value.

9.1.10.9 Serial Interfaces

Depending on the number and version of the system, the parameters for the serial interfaces can be configured in this menu.

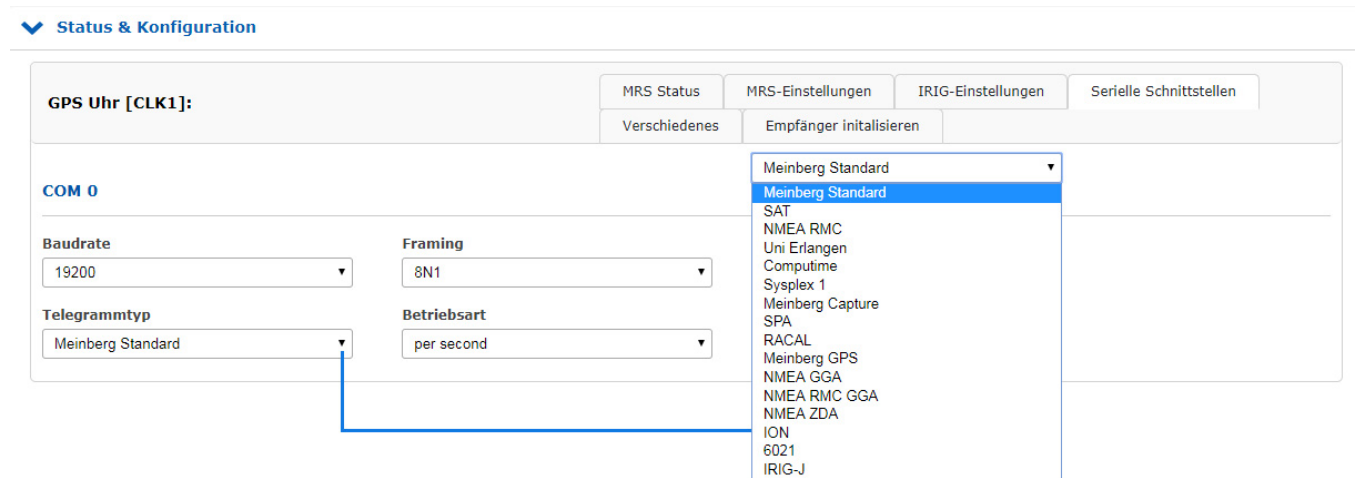

Baudrate: The speed with which the serial telegram is to be transmitted:
300, 600, 1200, 2400, 4800, 9600, 19200

Framing: Structure of the telegram:
7E1, 7E2, 7N2, 7O1, 7O2, 8E1, 8E2, 8N1, 8N2, 8O1

String Type: Meinberg Standard, SAT, NMEA RMC, Uni Erlangen, Computime, Sysplex 1, Meinberg Capture, SPA, RACAL, Meinberg GPS, NMEA GGA, NMEA RMC GGA, NMEA ZDA, ION, 6021, IRIG-J

Mode: You can configure an interval (per second, per minute, on request "?" Only) for the outgoing time string. If the operating mode is set on "Request", a connected client must send a "?" to receive the time telegram in response.

Features:

MRS PPS Plus String

If the system has the MRS "PPS plus string" option, the baudrate and framing for the incoming time string must be configured via this submenu.

Meinberg Capture *only for specific units*

This option is for systems that have a cap input. The event is triggered by a negative edge.

Two operating modes are available for the output of the capture time stamps, "on request ? Only" and "automatically".

on request "?" only

The triggered events are stored in a buffer of the reference clock. As soon as a "?" is sent to the reference clock via a serial connection, the stored events are transferred from the buffer.

automatically

In this mode, the capture events are output directly on the serial interface.

9.1.10.10 Time Zone

In this menu, you can configure the time zones (offsets) for the output signals (IRIG, serial interface, programmable pulses) of the reference clock.

The screenshot shows a web-based configuration interface for a 'Switch Card'. At the top, there are several tabs: 'IRIG Settings', 'Programmable Pulses', 'Synthesizer', and 'Time Zone'. Below these tabs, there are sub-tabs: 'Enable Outputs', 'Miscellaneous', and 'Initialize Receiver'. The main content area is titled 'Time Zone for External Outputs' and features a dropdown menu currently set to '(UTC+1) - CET/CEST'. Below the dropdown, there is a red text link that reads: 'Edit the time zone table in the display section of the system page. (Link)'.

The data of the time zone are used from the time zone table (see chapter 9.1.8.15 System → Display).

9.1.10.11 Enabling the Outputs

The screenshot shows the 'Enabling the Outputs' configuration page. It has the same top navigation tabs as the previous page: 'IRIG Settings', 'Programmable Pulses', 'Synthesizer', and 'Time Zone'. Below these are sub-tabs: 'Enable Outputs', 'Miscellaneous', and 'Initialize Receiver'. The main content area is divided into three sections, each with a dropdown menu: 'Pulses' (with options 'Always', 'If Sync', and 'Always' selected), 'Serial Outputs' (with 'Always' selected), and 'Synthesizer' (with 'Always' selected).

Optionally, the outputs of the reference clock can be set to always supply a signal when the device is switched on, or only when the internal clock is running synchronously.

9.1.10.12 Programmable Pulses

If the system has programmable switching outputs, you can configure the parameters in this menu.

- Mode:** Output signal configuration
also see [Description of Programmable Pulse Signal Types](#))
- Pulse length (ms):** Pulse length configuration.
- Cycle:** For "Cycle Pulse" mode, an interval can be configured in hh: mm: ss.
- Time:** In the configured mode "Single Shot", the time for the pulse can be parameterized in *hh:mm:ss*.
- DCF Suspend After (min):** In the "DCF77 Marks" mode, you can configure a shutdown time for the output port, so that in the case of an asynchrony of the reference clock, no DCF mark is available at the output.
- On / Off Time:** For the "Timer" mode, it is possible to configure start and stop times in *hh:mm:ss*.
- Signal:** Configuration of the output signal active in high or low.
- Disable output in Holdover mode:** If the reference clock is asynchronous, the output signal is immediately deactivated when the checkbox is activated.
- Note:** In the clock-submenu "Enabling the Outputs" the Pulses option "if sync" must be select so that the outputs can be switched off in holdover mode.

9.1.10.13 Synthesizer

The output frequency and phase of the integrated synthesizer can be set here.

Switch Card: IRIG Settings Programmable Pulses Synthesizer Time Zone
Enable Outputs Miscellaneous Initialize Receiver

Frequency
0 0 0 0 , 1/8 Hz

Phase
+ 0 , 0 °

Hz
kHz
kHz
kHz
MHz
MHz

Frequency: Frequencies from 1/3 Hz up to 10 MHz can be set by entering four digits and a frequency range. By entering the frequency 0 Hz, the synthesizer can be switched off.

Phase: With phase you can enter the phase position of the set frequency in the range -180° to $+180^\circ$ with a resolution of 0.1. When the phase angle is increased, the delay of the output signal gets bigger. If a frequency higher than 10 kHz has been set, the phase cannot be changed.

9.1.10.14 Miscellaneous

This menu item displays specific options of the reference clock.

▼ Status & Configuration

GPS Clock [CLK1]:

MRS Status
MRS-Settings
IRIG Settings
Serial Ports

Miscellaneous
Initialize Receiver

Cable Delay Compensation Method

By Length By Delay

Antenna Cable Length

 m

Compensation Time

 ns

GPS Simulation Mode

Log Satellite Visibility

Logged Satellite Visibility

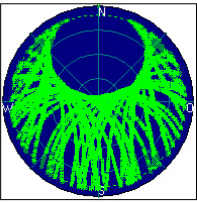

GLN Clock [CLK2]:

MRS Status
MRS-Settings
IRIG Settings
Serial Ports

Miscellaneous
Initialize Receiver

Satellite Navigation System Mode

Cable Delay Compensation Method

By Length By Delay

Antenna Cable Length

 m

Compensation Time

 ns

GPS Simulation Mode

Switch Card:

IRIG Settings
Programmable Pulses
Synthesizer
Time Zone

Enable Outputs
Miscellaneous
Initialize Receiver

GPS Time Scale

SSM Quality Level Hold-off Time

 Minutes

SSM Quality Level Wait-To-Restore Time

 Minutes

Antenna Cable Length (m):

The signal propagation time of the antenna cable can be compensated by this value. The received time signal is delayed by approx 5ns/m when using RG58U and 4ns/m when using H155 antenna cable. This time error is automatically compensated by entering the cable length. The default value is 20m. The maximum input value should not exceed 500m.

GPS Simulation Mode:

This menu allows the user to operate the time server without an antenna. Normally, the NTPD loses synchronization when the antenna or the external reference source is disconnected (red FAIL LED is turned on). By activating the simulation mode, the corresponding status information for the NTPD is permanently set to SYNC. This also makes it possible to transmit other times, which have been entered via the menu item "Initialize the receiver", to the NTPD. In normal cases, the checkbox should remain empty. If this box is activated, the status "Simulation mode" is displayed under "Info of the receiver" in the main menu.

GPS Time Scale:

UTC Coordinated Universal Time (including leap seconds which are continuously updated)

GPS since 1st of January 1980 - GPS System Time: monotonous time scale without leap seconds. Includes the leap seconds from 1970-1980.

TAI since the 1st of January 1970 - International Atomic Time: monotonous time scale without leap seconds. Difference to GPS Time: 19 seconds.

If you change the timescale in the drop-down menu a warning message will appear in the browser window.

Please Note:

If the GPS receiver is configured to output GPS or TAI timescale instead of UTC, the distributed time via NTP isn't based on UTC then. This is a protocol violation and this time server can't be used to synchronize standard NTP clients which expect UTC time.

Log Satellite Visibility (GPS Receiver):

If this item is activated, a graphic is generated on which the constellation of the visible satellites are displayed.

SSM Quality Level in GPS Lock Mode:

If the system has E1 / T1 outputs, the quality level of the SSM can be configured here.

SNS Mode - Satellite Navigation System Mode (GNS Receiver):

If you are using a GNS receiver (GNS or GNS-UC with Up Converter), this drop-down menu allows you to select one or more satellite systems to be used simultaneously.

The following combinations can be selected and received simultaneously:

| GNS Receiver | GNS-UC Receiver | GNM-Receiver |
|---------------------|-----------------|--|
| GPS only | GPS only | GPS |
| GLONASS only | Galileo only | GLONASS |
| Galileo only | GPS/Galileo | Galileo |
| BeiDou only | | BeiDou |
| GPS/GLONASS | | (All available systems can be received simultaneously) |
| GPS/Galileo | | |
| GPS/BeiDou | | |
| Galileo/GLONASS | | |
| Galileo/BeiDou | | |
| GLONASS/BeiDou | | |
| GPS/Galileo/GLONASS | | |
| GPS/Galileo/BeiDou | | |

Distance to the Transmitter (km) - PZF / AM Receivers only:

In the menu item "Distance to the Transmitter" you can enter the transmitter distance in km, which is used for the delay compensation of the incoming PZF-signal. The adjustment of the distance should be made as precisely as possible, because it has a direct influence on the absolute accuracy of the time raster.

PZF Simulation Mode:

This menu allows the user to operate the time server without an antenna. Normally, the NTPD loses synchronization when the antenna or the external reference source is disconnected (red FAIL LED is turned on). By activating the simulation mode, the corresponding status information for the NTPD is permanently set to SYNC. This also makes it possible to transmit other times, which have been entered via the menu item "Initialize the receiver", to the NTPD. In normal cases, the checkbox should remain empty. If this box is activated, the status "Simulation mode" is displayed under "Info of the receiver" in the main menu.

9.1.10.15 Initialize Receiver

The screenshot shows the 'GPS Clock [CLK1]:' configuration interface. At the top, there are tabs for 'MRS Status', 'MRS-Settings', 'IRIG Settings', and 'Serial Ports'. Below these are sub-tabs for 'Miscellaneous' and 'Initialize Receiver'. The 'Initialize Receiver' sub-tab is active. It contains two buttons: 'Warm Boot Mode' and 'Cold Boot Mode'. Below these are input fields for Latitude (51, 58, 56) and Longitude (9, 13, 33), with dropdown menus for 'N' and 'E'. An 'Altitude' field is set to 166 m. An 'Initialize Position' button is at the bottom.

Warm Boot Mode only for GNSS receiver:

This menu allows the user to switch the receiver to WARMBOOT MODE. This may be necessary if the satellite data in the battery-buffered memory is too old, or if the device is operated at a location that is several hundred kilometers away from the last operating location, since the calculation of the visibility of the satellites yields incorrect results.

Cold Boot Modus only for GNSS receiver:

This menu allows the user to reinitialize all GPS system values, this means that all stored satellite data will be deleted. Please note that the receiver takes about 15 minutes to read-in the information of the satellites again, to complete the cold boot!

Coordinates (latitude, longitude, and altitude) *only GNSS receiver:

The absolute position of the GPS antenna can be entered here and can be sent to the GPS reference clock with "initialize Position". This option is useful when the system is operated at a different location and if started with the previously battery-buffered satellite data.

Time/Date:

With this function, the reference clock can manually be set to a specific date and time.

9.1.10.16 Receiver Information

| GPS Clock [CLK1]: | |
|---------------------------------------|---|
| | Common Information |
| | Special Information |
| Name | Value |
| Model: | GPS180 |
| Serial Number: | 052311051270 |
| Software Revision: | v2.37 (Standard) |
| Oscillator Type: | OEXO SQ |
| Supported Features: | Pulse Per Second, Programmable Synth., IRIG Out, IRIG In, Ignore Lock, Ext. Multiple Ref. Src. Cfg., Configurable Time Scale, Multiple XMRS Instances, 10 MHz Output Disabled, Event Logging, IMS data, Extended Features |
| Number of Programmable Pulse Outputs: | 4 |
| Number of Serial Ports: | 3 |

This menu item lists all the important information and options of the reference clock.

Explanation of GPS Satellite Status "Satellites in View" and "Number of Good Satellites"

Satellites of the GPS and other GNSS systems are usually not stationary, but circle around the globe on well-known tracks, so each individual satellite may be above or below the horizon at a given location and time. Satellites that are below the horizon can't be tracked anyway, so the receiver uses its last known position and almanac data from the satellites to determine which satellites are currently expected to be above the horizon at its geographic position, and can potentially be tracked. All these satellites are called to be **in view**.

However, even some the satellites that are in view may be shielded by buildings, mountains, etc., so the receiver may be unable to track these satellites. Also, individual satellites may be temporarily in maintenance mode, so they must not be used even if they can be tracked. Only satellites that can be tracked and are not in maintenance mode are considered **good** and used to determine the current position and time.

So the number of **good** satellites can never exceed the number of satellites in view, but it can be significantly less if the antenna has been installed in a location with limited view to the sky. In worst case this can lead to limited accuracy, or only temporary synchronization.

9.1.10.17 Switch Card

The RSC (SCU) switch card is an automatic multiplexer for redundant systems with two Meinberg radio clocks. The card is used for the automatic switching of the pulse and frequency outputs as well as the serial interfaces of the connected clocks. The selection of the respectively active system is made, based on the state of the clock's generated TIME_SYNC signals, which show the synchronous state of the clocks.

In order to avoid unnecessary switching operations, for example during periodic free running of a system, the order of the active and the reserve system is exchanged at every change-over. For example, if the active system switches to the free running mode while the reserve system is operating synchronously, it is switched over to the synchronous reserve system. A reset to the old state occurs only if the now active system (formerly the reserve system) loses synchronization, while the reserve system (previously active system) operates synchronously. If both systems operate in the free-running mode, no changeover is made and the current state is retained.

9.1.10.18 Receiver Information Switch Card

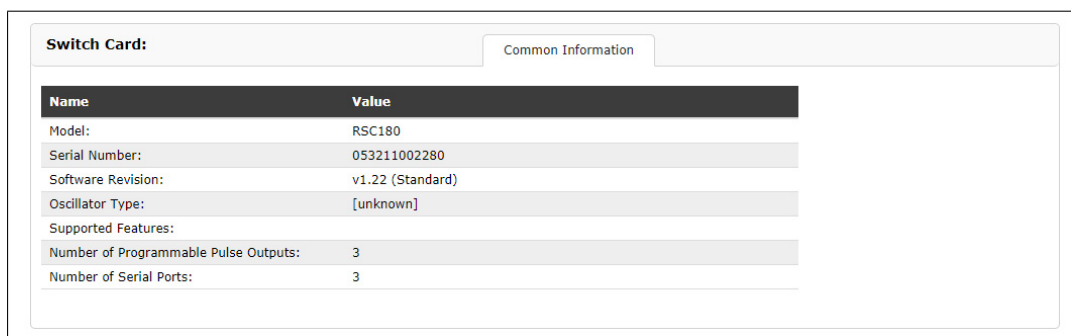

The screenshot shows a web interface for the 'Switch Card' configuration. It features a tabbed menu with 'Common Information' selected. Below the tabs is a table with two columns: 'Name' and 'Value'. The table lists the following information:

| Name | Value |
|---------------------------------------|------------------|
| Model: | RSC180 |
| Serial Number: | 053211002280 |
| Software Revision: | v1.22 (Standard) |
| Oscillator Type: | [unknown] |
| Supported Features: | |
| Number of Programmable Pulse Outputs: | 3 |
| Number of Serial Ports: | 3 |

This menu item lists all the important information and options of the switch card.

9.1.11 I/O Configuration

This menu is available on IMS systems only. Input and output modules can be configured here.

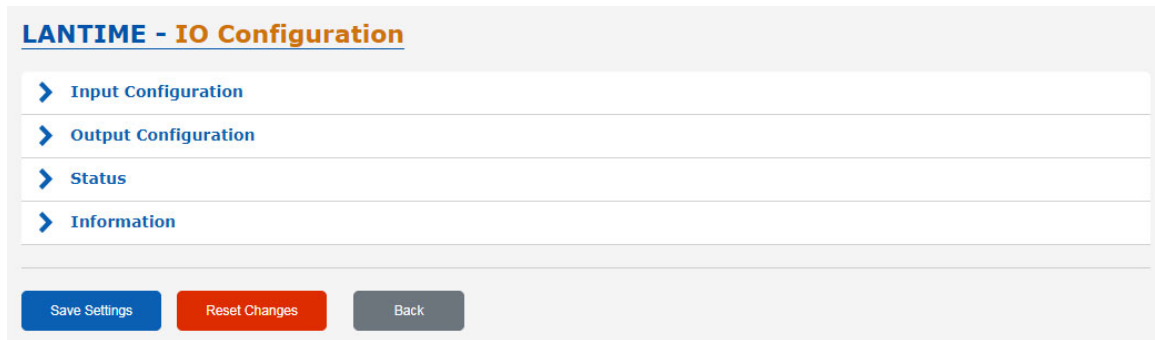

9.1.11.1 Input Configuration

9.1.11.2 IMS-MRI (Multiple Reference Input)

If an application requires to use external synchronization sources instead of radio/GNSS signals, a MRI card enables the installed clock module to synchronize to 1PPS, 10MHz, DCLS and AM time codes.

Each MRI card is dedicated to one clock module. If a redundant solution requires external synchronization inputs for both clock modules, two MRI cards have to be installed. The MRI card is available with 4x BNC or 4x FO connectors.

Basic reference input signals

- 1PPS
- 10 MHz
- IRIG-AM (B, AFNOR, IEEE1344 / C37.118)
- IRIG-DCLS (B, AFNOR, IEEE1344 / C37.118)

For further and detailed configuration settings of the MRI card please look at chapter 9.1.10 - "Web GUI → Clock → MRS Settings".

9.1.11.3 IMS-ESI (Extended Synchronization Interface)

The ESI (External Synchronization Input) card is capable of adding additional synchronization sources to an IMS system. It accepts E1 or T1 signals, both as framed signals (2.048MBit/s/1.544MBit/s, supporting SS-M/BOC) or clock inputs.

The clock inputs are configurable (1 kHz - 20 MHz). Furthermore a 1PPS input is provided as well.

An ESI card is, as the MRI card, dedicated to one specific clock module (depending on the slot it is installed in) and can be installed in both ESI as well as MRI slots.

Extended reference input signals

- 1PPS, BNC
- var. frequencies (1 kHz - 20 MHz) unframed, BNC
- var. frequencies (1 kHz - 20 MHz) unframed, RJ45
- BITS E1/T1 framed, RJ45

Hint:

If the specified frequency range is exceeded, an error message is displayed in the web interface and the entered value is not accepted in this case.

Input 1: The input 1 is dedicated to 1PPS pulse synchronization.

ESI - External Synchronization Interface 1 [Chassis 0, Slot ESI1] Input 1 Input 2 Input 3 Input 4

Type
PPS in

ITU Quality Settings

ITU mask
G811 (PRC)

Hysteresis
24 %

Discard input signal if selected ITU mask violated

Label

Signal Type – PPS in

ITU Quality Settings

(settings can be made individually for inputs 1 to 4)

ITU Mask.

Predefined masks can be selected, in which quality requirements regarding jitter and wander of the input signals are defined. If the default values are exceeded, the affected input port is switched off.

Hysteresis.

To avoid that signal inputs are continuously switched off and back on when exceeding the ITU mask, a hysteresis for switching on again can be defined. The signal input port is only reactivated when all the selected mask points are below the defined percentage value's limits.

Discard input signal if selected ITU mask violated.

Only if this box is selected, the input signal is switched off when exceeding an ITU mask.

Input 2: The input 2 accepts as input either 2048/1544 kHz frequency or configurable frequency in range between 1 kHz and 20 MHz, also 1.544kHz if required.

ESI - External Synchronization Interface 1 [Chassis 0, Slot ESI1]

Input 1 Input 2 Input 3 Input 4

Type
Freq. In

Frequency
10 MHz

Maximum Slip
1.5 Cycles

ITU Quality Settings

ITU mask
None

Hysteresis
0 %

Discard input signal if selected ITU mask violated

Label

Type: Frequency input

Frequency: 1 kHz – 20 MHz of input signal, 10 MHz is set as default.

Maximum Slip: A discontinuity of an integer number of cycles in the measured carrier phase resulting from a temporary loss of input signal. The maximum slip number can be selected in range between 0.5 – 3 cycles, with 1.5 as a default value.

Input 3:

See Input 2, but with RJ45 Connector and as default Frequency input 2048 kHz.

Input 4: As fixed frequency you can choose between E1 framed and T1 framed.

The screenshot shows the configuration interface for 'ES1 - External Synchronization Interface 1 [Chassis 0, Slot ES11]'. It features several tabs: 'Input 1', 'Input 2', 'Input 3', and 'Input 4'. The 'Input 4' tab is active. The configuration includes:

- Type:** BITS In
- Fixed Frequency:** E1 framed (with a dropdown menu showing 'E1 framed' and 'T1 framed')
- Minimum Quality Level:** QL-PRS (with a dropdown menu showing various quality levels like QL-PRS, QL-STU/UKN, QL-PRC, etc.)
- Sa Bits Group:** Sa4 (with a dropdown menu showing 'Sa4', 'Sa5', 'Sa6', 'Sa7', 'Sa8')
- ITU Quality Settings:**
 - ITU mask: None
 - Hysteresis: 13 %
 - Discard input signal if selected ITU mask violated
- Label:** (empty text field)

Type: BITS in.

Fixed Frequency: E1 framed (2.048 MHz), T1 framed (1.544 MHz).

Quality: Synchronization Status Messages (SSM), Bit-Oriented Code (BOC).

Sa Bits Group: Location of transmitted SSM/BOC

Quality Maximum SSM / Maximum BOC (quality levels for T1 framed signal)

Synchronization Status Message (SSM) in accordance with ITU G.704-1998 standard includes 4 bit long SSM quality messages received via incoming E1 framed signal. The lower is the bit sequence the higher is quality of the source clock. The clock source quality levels according to G.704-1998 are as follows:

| | | |
|------|---------------|---|
| 0000 | QL-STU/UKN: | Quality unknown |
| 0001 | QL-PRS: | Primary Reference Source |
| 0010 | QL-PRC: | Primary Reference Clock |
| 0011 | QL-INV3: | not used |
| 0100 | QL-SSU-A/TNC: | Synchronization Supply Unit A or Transit Node Clock |
| 0101 | QL-INV5: | not used |
| 0110 | QL-INV6: | not used |
| 0111 | QL-ST2: | Stratum 2 Clock |
| 1000 | QL-SSU-B: | Synchronization Supply Unit B |
| 1001 | QL-INV9: | not used |
| 1010 | QL-EEC2/ST3: | Ethernet Equipment Clock 2 |
| 1011 | QL-EEC1/SEC: | Ethernet Equipment Clock 1 / SDH Equipment Clock |
| 1100 | QL-SMC: | SONET Minimum Clock |
| 1101 | QL-ST3E: | Stratum 3E Clock |
| 1110 | QL-PROV: | Provisionable by the Network Operator |
| 1111 | QL-DNU/DUS: | Do not use for synchronization |

With the Quality Selection box, you can select the Minimum SSM level of the incoming signal that is still acceptable as input signal. If clock reports a lower quality level than the configured minimum SSM level the system will not use it for synchronization.

Example:

User configured QL-SSU-B as Minimum QL for his system. An E1 input signal reporting either QL-SSU-A or QL-PRC will be allowed for synchronization, whereas a signal with quality level QL-EEC1/SEC will not be accepted.

Sa Bits Group

Here you can select between the Sa4 to Sa8 bit group to choose the location for SSM quality bits.

9.1.11.4 VSI Configuration via the Web Interface

VSI - Video Signal Input References

Menü "IO Config → Input Configuration → VSI-Karte"

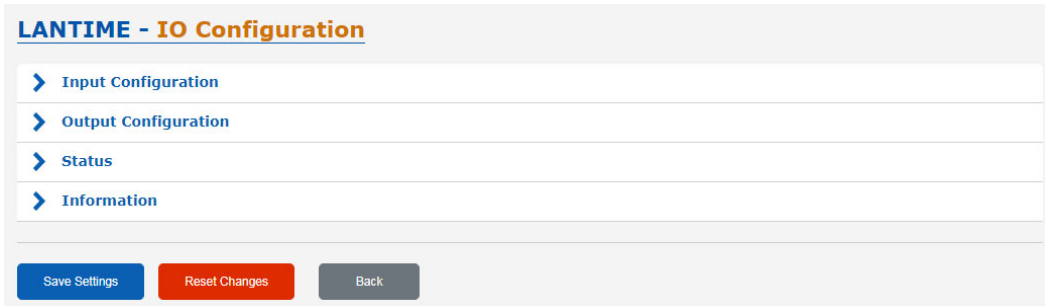

Video Sync Interface: configurable Inputs

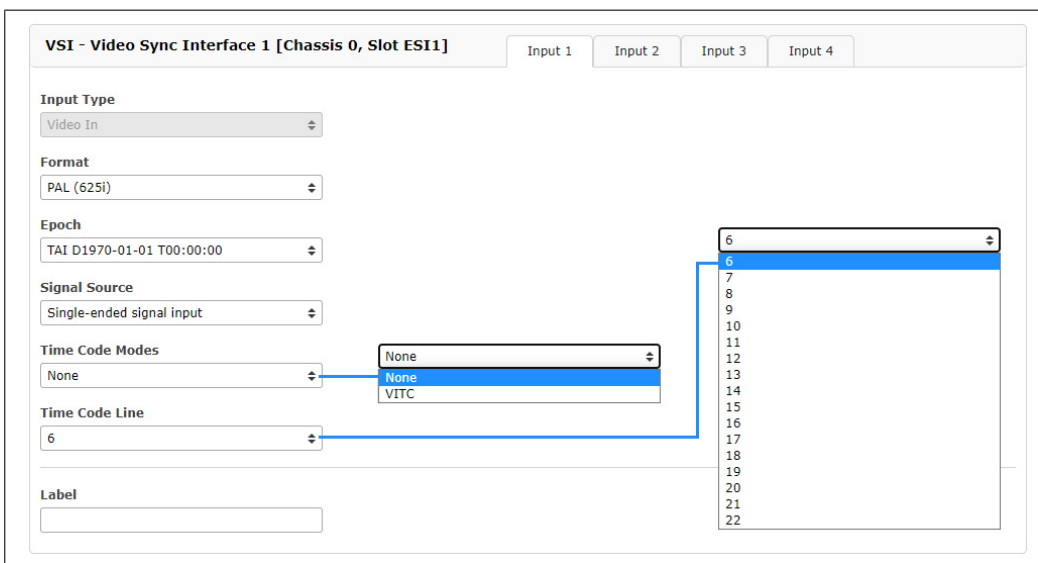

- Input 1:** Video Sync In
- Format:** PAL 625i
- Epoch:** TAI
- Signal Source:** Single-ended signal input
- Time Code Modes:** VITC
- Time Code Line:** 6 - 22

Input 2: LTC In
Type: LTC 25 FPS (Frames per Second)
Daily Jam Time: Time of Day (hh:ii)

Input 3: Word Clk In
Port Type: GPIO (General Purpose Input Output)
Direction: Input
Operation Mode: Always enabled

VSI - Video Sync Interface 1 [Chassis 0, Slot ES11] Input 1 Input 2 Input 3 Input 4

Port Type
PPS

Direction
Input

Operation Mode
Always enabled

Label

Input 4: PPS In

Pulse length: $\geq 5\mu\text{s}$, active high

9.1.11.5 Output Configuration

9.1.11.6 IMS BPE

BPE (Basic Port Expansion)

The standard BPE is a passive module and is one of the IMS output modules. When ordering, the customer chooses between different physical connections and signal levels which are generated by the reference clock.

The BPE is pre-configured with the following signals:

- 1PPS, 10 MHz TTL
- 2048 kHz
- Programmable Pulses, provided by clock module (also see [Description of Programmable Pulse Signal Types](#))
- IRIG DCLS+AM (B, AFNOR, IEEE1344 / C37.118)
- ...

There are no other configuration settings for a standard BPE card in the I/O Config menu. For further detailed settings on output signals of the BPE card please proceed to the Clock Configuration Chapter 9.1.10.

BPE8000 series: switchable output signals

The screenshot shows the configuration page for 'BPE - Basic Port Expander 1 [Chassis 0, Slot IO2]'. It features four tabs for 'Port 1', 'Port 2', 'Port 3', and 'Port 4'. The 'Port 1' tab is active. On the left, there are three dropdown menus: 'Port Type' (set to 'PPS'), 'Direction' (set to 'Output'), and 'Operation Mode' (set to 'Passed through'). Below these is a 'Label' input field. A dropdown menu is open for 'Port Type', showing options: 'PPS', '10 MHz', '2048 KHz', 'Timecode', 'Prog. Output 1', 'Prog. Output 2', 'Prog. Output 3', and 'Prog. Output 4'. The 'PPS' option is currently selected and highlighted in blue.

The BPE8000 series with eight different BNC and ST connector combinations, offers freely configurable output signals via the web interface of an IMS system. An electronically controlled switch (multiplexer) on the module board allows the selection of the signals to be distributed by the receiver module via the backplane.

9.1.11.7 IMS CPE

This module consists of a half-size standard controller card (Back-End) and a connected port expander card (Front-End), allowing a large variety of available and programmable output signals and physical connectors, including various electrical and optical interfaces.

The main menu of the CPE provides access to specific submenus where the available output signals can be configured.

IMS – CPE available Signals:

- 1PPS, 10 MHz
- Time Codes: IRIG A/B/E/G/AFNOR/IEEE1344/C37.118/NASA36
- Frequency Synthesizer (sine- wave + TTL)
- Programmable Pulses: 1PPS, 1PPM, 1PPH, Timer. Single Shot, etc.
- Cyclic Pulses; DCF77 Mark, Sync Status
- Serial Timestrings (RS232 or RS 422 / 485)

Submenus

Common:

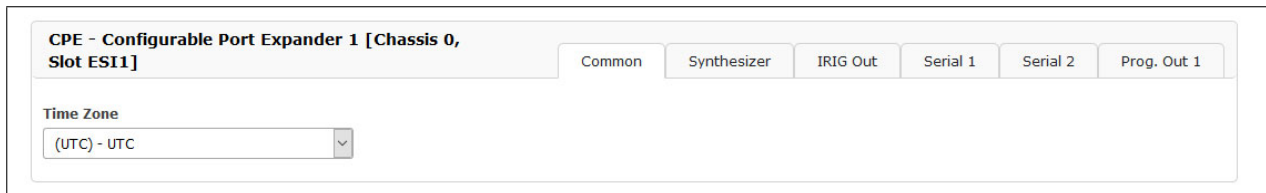

Time Zone Choose local timezone

Submenu Synthesizer:

The screenshot shows the 'Synthesizer' tab of the 'CPE - Configurable Port Expander 1 [Chassis 0, Slot ES11]' configuration page. It features two input fields: 'Frequency' with four digit spinners (0, 0, 0, 0) and a 'Hz' unit dropdown, and 'Phase' with a '+' sign spinner (0) and a degree symbol spinner (0).

Frequency 1/8 Hz to 10 kHz: Phase synchronous to pulse per second
 10 kHz to 10 MHz: deviation of frequency < 0.0047 Hz

Phase Edit the frequency and phase to be generated by the on-board synthesizer. Frequencies from 1/8 Hz up to 10 MHz can be entered using four digits and a range. If frequency is set to 0 the synthesizer is disabled. With "Phase" It is possible to enter the phase of the generated frequency from -360° to $+360^\circ$ with a resolution of 0.1° . Increasing the phase lets the signal come out later. Phase affects frequencies less than 10.00 kHz only!

IRIG Out

The screenshot shows the 'IRIG Out' tab of the 'CPE - Configurable Port Expander 1 [Chassis 0, Slot IO6]' configuration page. It features two dropdown menus: 'Output Timecode' and 'Time Scale'. The 'Output Timecode' dropdown is open, showing a list of options including B002+B122, B003+B123, A003+A133, AFNOR NF S87-500, IEEE 1344, B006+B126, B007+B127, G002+G142, G006+G146, IEEE C37.118, E002+E112, and NASA 36. The 'Time Scale' dropdown is currently set to 'UTC'.

IRIG Output Code Output code that is selected for the CPE.

Time Scale Select the time scale (UTC or local time) which forms the time base for signals with time information (e.g. time code signals).

The individual time code formats are explained in more detail in the chapter [12.3, "Description of Time Code Formats"](#).

Programmable Outputs

CPE - Configurable Port Expander 1 [Chassis 0, Slot ES11]

Common
Synthesizer
IRIG Out
Serial 1
Serial 2
Prog. Out 1

Mode

Pulse Per Second
▼

Pulse Length

DCF Suspend After

On Time

Off Time

On Time

Off Time

On Time

Off Time

Signal

Normal
▼

Disable Output in Holdover Mode

Label

- Idle
- Timer
- Single Shot
- Cyclic Pulse
- Pulse Per Second
- Pulse Per Min
- Pulse Per Hour
- DCF77 Marks
- Position OK
- Time Sync
- All Sync
- DCLS Time Code
- Synthesizer Frequency

The individual programmable output signals are explained in more detail in the chapter [12.4, "Description of Programmable Pulse Signal Types"](#).

9.1.11.8 IMS - LIU (Line Interface Unit)

E1/T1 – generator available with 4 or 8 outputs

Generation of reference clocks for synchronization tasks. The module LIU (Line Interface Unit) generates different reference clock pulses which are derived from the GPS-locked master oscillator of a preconnected GPS clock. The output signals are available with high accuracy and stability therefore.

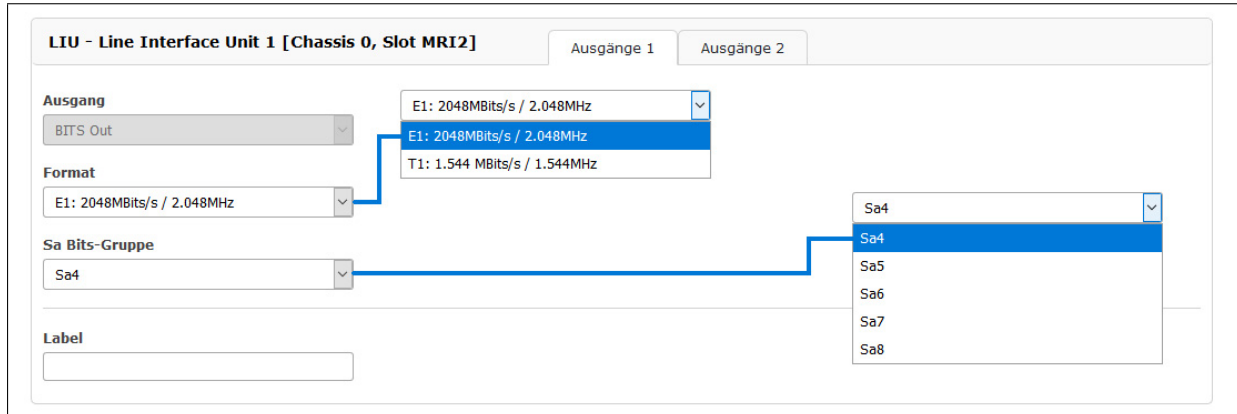

Submenu Output 1:

Output Type

Clock Outputs: 2.048 MHz (E1-mode) or 1.544 MHz (T1-mode), G.703, 75 Ohm, unbalanced or 2.048 MHz (E1-mode) or 1.544 MHz (T1-mode), G.703, 120 Ohm, balanced.

BITS framed outputs with SSM/BOC support:
2.048 Mbit/s (E1-mode) or 1.544 Mbit/s (T1-mode), 75 Ohm unbalanced
or 2.048 MPs (E1-mode) or 1.544 Mbit/s (T1-mode), 120 Ohm, balanced.

Format E1 framed (2.048 kBit) or T1 framed (1.544 kBit)

Quality Sa Bit group location of SSM QL bits

With the pull-down menu "Output Configuration" the available outputs of the I/O slots can be configured:

Output Configuration of a LIU module (Line Interface Unit):

In this menu one can select between E1 or T1 mode for the LIU outputs. The selected mode is the same for all outputs.

T1 or E1?

T1 is a digital carrier signal that transmits the DS - 1 signal. It has a data rate of about 1.544 Mbit/second. It contains 24 digital channels and therefore requires a device that has a digital connection.

E1 is the european equivalent to T1. T1 is the North American term whereas E1 is a European term for digital transmission. The data rate of E1 is about 2 Mbit/second. It has 32 channels at the speed of 64 Kbit/second. 2 channels among 32 are already reserved.

One channel is used for signaling while the other is used for controlling. The difference between T1 and E1 lies in the number of channels here.

Sa Bits

ITU-T Recommendations allow for bits Sa4 to Sa8 to be used in specific point-to-point applications (e.g. transcoder equipment) within national borders.

The Sa4 bit may be used as a message-based data link for operation, maintenance and performance monitoring. The SSM Bit (Synchronization Status Message) can be selected in the Web GUI for clock quality information. Sa4 is selected as default.

9.1.11.9 IMS - SCG Studio Clock Generator

SCG-U - Word Clock Generator, unbalanced

Output Configuration

SCG - Studio Clock Generator 1 [Chassis 0, Slot IO1]

Output 1 Output 2 Output 3 Output 4

Output Type
Studio Clock Out

State
Enabled

Base Frequency
48 kHz

Scale
1

Label

48 kHz
32 kHz
44.1 kHz
48 kHz

1
1/8
1/4
1/2
1
2
4
8
16
32
64
128
256

This module is not only designed for our IMS series and generates various audio frequencies for studio applications. The SCG module can also operate in our 19-inch rackmount and 1U Multipac chassis.

- Programmable word clock rates: 24Hz – 12,888MHz
- reference inputs: 1PPS, 10MHz, serial timestring

Output Type Studio Clock Out (Word Clock) or Digital Audio Out (DARS)

State on or off

Base Frequency 32kHz, 44.1kHz, 48kHz

Scale possible scales depends on base frequency
choose a base frequency and a scale to get the right frequency at output x

Example: Output 3 state Enabled base 48kHz, scale 1/8

Output 3 = Base-Frequency * Scale

48kHz * 1/8 = 6kHz on output 3

SCG-B - DARS Generator, balanced

The SCG-B is an additional card for generating "Digital Audio Reference Signals" for studio applications. The 25pin D-Sub female connector provides four DARS outputs, which can be configured here in the IO Config menu.

Sample Configuration: SCG-B Output 1

The screenshot shows the configuration interface for the SCG - Studio Clock Generator 1, specifically for Output 1. The interface includes a title bar with the device name and slot information, and four tabs for Output 1, Output 2, Output 3, and Output 4. The main configuration area contains three sections: Output Type, Signal Type, and Label. The Output Type is set to Digital Audio Out. The Signal Type is set to DARS 48 kHz, and a dropdown menu is open showing options: DARS 48 kHz, OFF, DARS 48 kHz, and DARS 44.1 kHz. The Label field is empty.

| Section | Value |
|-------------|-------------------|
| Output Type | Digital Audio Out |
| Signal Type | DARS 48 kHz |
| Label | |

In the menu "IO Configuration" you can set the output on DARS for every output of the SCG-B. The four available outputs can optionally be switched off.

9.1.11.10 IMS - VSG

The VSG modules provide video signal reference signals for studio equipment.

The IMS-VSG181 offers four BNC connectors through which it provides an analog black & burst or tri-level sync signal, a Linear Time Code signal (LTC), a Digital Audio Reference Signal (DARS), and a word clock signal.

The IMS-VSG181H offers two BNC connectors through which it provides an analog black & burst or tri-level sync signal and a Digital Audio Reference Signal, as well as 15-pin D-Sub GPIO connector through which LTC (balanced and unbalanced), DARS (balanced only) and word clock signals (unbalanced only) are output.

Function

The VSG modules are synchronized against an external reference frequency (10 MHz), a pulse-per-second signal (PPS), and a time string from an upstream clock to generate a variety of configurable video output signals. The signal outputs are phase-matched with the PPS signal.

VSG - Video Signal Generator 2 [Chassis 0, Slot MRI1]

Ausgänge 1 Ausgänge 2 Ausgänge 3 Ausgänge 4 Ausgänge 5 Ausgänge 6 Misc

Ausgang
Video Out

Betriebsart
if sync and warmed up

Epoche
TAI D1970-01-01 T00:00:00

Format
NTSC (525i)

Vertikaler Offset
0 Zellen

Horizontaler Offset
0 ns

Timecode
None

1. Time Code Zeile
19

2. Time Code Zeile
21

Daily Jam Time
00 Stunden 00 minuten

Lokaler Offset aus PTP TLV verwenden, wenn im PTP Slave Modus.

Label

Dropdown menus:

- Betriebsart:** If sync, only; If warmed up, only; If sync and warmed up
- Format:** OFF; NTSC (525i); PAL (625i); 720p 50 Hz; 1080i 50 Hz; 720p 59.94 Hz; 1080i 59.94 Hz
- Timecode:** None; VITC; VITC w. daily jam; VITC w. daily jam and drop frame

Signal Outputs:

Black Out: NTSC (525i) (59.94 Hz, "Black & Burst", ITU-R BT.1700/SMPTE ST 170:2004)
 PAL (625i) (50 Hz, "Black & Burst", ITU-R BT.1700)
 720p 50 Hz (Tri-Level Sync, SMPTE ST 296)
 1080i 50 Hz (Tri-Level Sync, SMPTE ST 274)
 720p 59.94 Hz (Tri-Level Sync, SMPTE ST 296)
 1080i 59.94 Hz (Tri-Level Sync, SMPTE ST 274)

DARS: DARS 48 kHz
 DARS 44.1 kHz

LTC: LTC 24 fps / 23.976 Hz
 LTC 24 fps
 LTC 25 fps
 LTC 30 fps
 LTC 30 fps Drop Frame (for NTSC content with a frame rate of 29.97 fps)

Word Clock: Sample rates - 44.1 kHz or 48 kHz

Scale factors - 1/32, 1/16, 1/8, 1/4, 1/2, 1, 2, 4, 8, 16, 32

Information:

By default, all of the supported synchronization signals are only output if the reference clock is synchronized and the internal oscillator is adjusted. This configuration represents the most reliable signal output. However, it can take several hours for the signals to be output after booting. Part of this process can be skipped (with the corresponding risk of temporary timing inaccuracies) by configuring the module to output the signals with a synchronized clock while disregarding the adjusted state of the oscillator, or with an adjusted oscillator regardless of the synchronization state (holdover).

9.1.11.11 IMS - LNO (Low Phase Noise Option)

The IMS-LNO is a 10MHz generator card, which provides 10MHz sine signals with low phase noise to 4 external outputs. The card has a microprocessor system, which monitors the output signals and generates status signals for the upper-level management system accordingly.

It can be used in our modular IMS Systems and also be applied in M900 timeserver platform and GPS based 3U housing, but without management functions.

The card has a high quality oscillator, which is locked to an external 10MHz signal. The microprocessor monitors the lock status of the PLL and the warm up phase of the oscillator. It activates the outputs only after the phase is locked.

This condition is signalized by the LEDs. In the phase locked state, the output levels of the four outputs are monitored, and in case of a failure signalized by an associated LED.

| | Non-IMS-Systems | IMS-Systems |
|------------|---|---|
| First LED | Status Output 1 Green: Ok Red: Error | St - Status of the LNO180 card Green: 10MHz reference ok and PLL has locked Yellow: 10MHz reference ok but PLL is not locked yet Red: No 10MHz reference detected |
| Second LED | Status Output 2 Green: Ok Red: Error | In - 10MHz reference and PLL status Green: Ok, 10MHz available at both outputs Red: Error, no signal at one or both outputs |
| Third LED | Status Output 3 Green: Ok Red: Error | A - Output 1-2 status Green: Ok, 10MHz available at both outputs Red: Error, no signal at one or both outputs |
| Fourth LED | Status Output 4 Green: Ok Red: Error | B - Output 3-4 status Green: Ok, 10MHz available at both outputs Red: Error, no signal at one or both outputs |

Output can not be active, before PLL is locked.

9.1.11.12 Other Output Modules

Network Cards:

LNE

The LNE card adds additional network interfaces to the management CPU, increasing the number of NTP and management ports available.

The additional ports can be used to separate network traffic on physical network segments. For further configuration options please see the chapter "9.1.2".

For further detailed configuration settings for this card please see chapter 9.1.2, "Web GUI → Network menu".

HPS / TSU - IEEE 1588 Time Stamp Units

A Meinberg time stamping unit provides a future-proof platform for your IEEE 1588 / SyncE / Carrier Grade NTP infrastructure. The high-power dual-core processor, the 1-step master clock and the 1GE interface with SFP slot supports a large number of PTP clients.

The ability to select Master and Slave operation for either Default, Power, Telecom or SMPTE profile makes this product the most flexible PTP solution on the market, suitable for a wide range of applications.

A lot of IEEE 1588 slave devices or NTP clients from different market segments can be synchronized, even over IPv6 networks, for example eNodeB's for LTE base stations, Linux servers with hardware-assisted time stamping support for high-frequency trading applications, IEEE 1588 compatible IEDs in Smart Grid environments or IP-interconnected Audio / Video devices in broadcast studios.

The Synchronous Ethernet function provides a high accurate frequency transport over Ethernet networks. The card can be used either to take a SyncE signal from the network as a source or generate SyncE as a Master.

For further information on PTP features and detailed configuration for this card please proceed to Chapter 9.1.6, "Web GUI → PTP menu".

9.1.11.13 IMS Input/Output Cards

9.1.11.14 PIO - PPS/10MHz Input/Output Module

The PIO module is pre-configured by a jumper. The default configuration of all ports is PPS (Pulse Per Second). If this pre-configuration needs to be changed to 10MHz, the card must be removed and the jumper position adjusted.

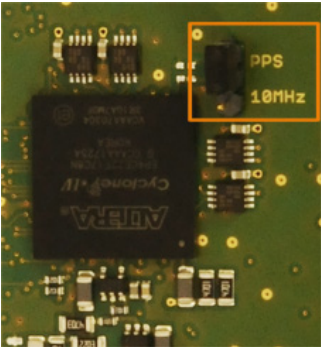

PIO - Programmable Input/Output Module 1
[Chassis 0, Slot IO3]

Port 1 Port 2 Port 3 Port 4

Port Type
PPS

Direction
Input
Output
Enabled

Label

Via the web interface, each port can be set separately to "Input" or "Output". If a port is set to "Output", the system PPS or the 10 MHz reference frequency is output signal at this port. If a port is set to "Input" the incoming signal is compared to the system PPS or to the 10MHz reference frequency. The offset values are displayed in the status window.

PIO - Programmable Input/Output Module 2 [Chassis 0, Slot ES11]

| Input | Type | Status | Offset |
|---------|--------|---|---------------|
| Input 1 | PPS in | Carrier detected, Input signal is avail | -0.000000041s |
| Input 2 | PPS in | Carrier detected, Input signal is avail | -0.000000041s |
| Input 3 | PPS in | Input signal is currently lost | |
| Input 4 | PPS in | Input signal is currently lost | |

| Temperature Sensor 1 | Temperature Sensor 2 |
|----------------------|----------------------|
| Current: 47.00°C | Current: 45.00°C |

9.1.12 Sync Monitoring

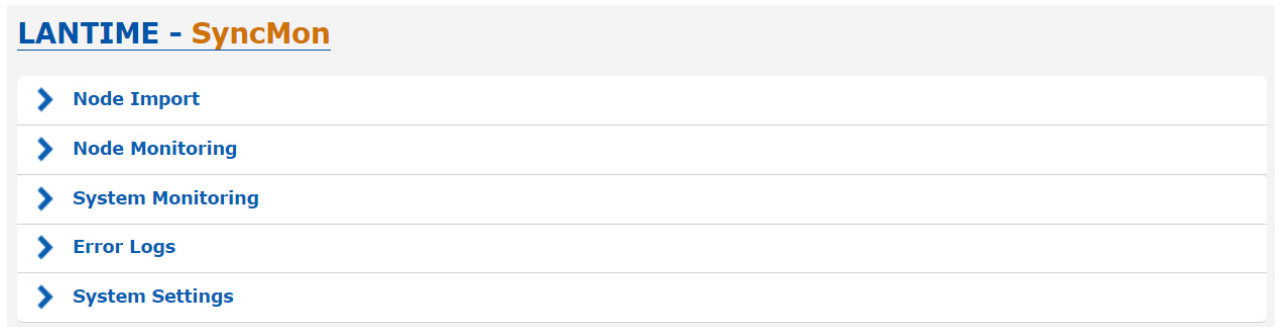

Figure: Sync Monitor dialog in the LANTIME Web GUI.

9.1.12.1 Sync Monitoring Introduction

The Sync Monitoring feature is used for measuring, monitoring and reporting of network nodes' accuracy against a UTC traceable source (eg. GPS, multi-GNSS or national timing service, e.g. NPL). The Sync Monitoring node can monitor nodes synchronized by network protocols PTP (IEEE 1588v2) or NTP (RFC1305).

PTP nodes need to support the Meinberg TLV approach or standard PTPv2 Management messages, otherwise they cannot be monitored. NTP nodes can only be monitored if they are configured to respond to NTP client requests (Note: A NTP client that is using the Windows Time Service W32Time does not respond to NTP client requests per default configuration. W32Time needs to be configured to act as client and server at the same time. Otherwise the node cannot be monitored via SyncMon).

However, also all configured MRS, FDM, PIO and ESI inputs (like PPS and Freq inputs) can be monitored if an ESI (Extension Signal Input) card is available. The Sync Monitor feature is now available on Meinberg IMS Systems with firmware version 7.00 or later and for PTP monitoring with integrated HPS-100 PTP card with a minimum 1024 client performance license.

The Sync Monitor can run either as a node independent from a master clock. In this case a Sync Monitor node can be located basically anywhere in the network; but most probably as close as possible to the slaves to be able to measure their actual accuracy. At the same time you can monitor also the performance of a GM and measure the potential network asymmetry which is present in the link between a GM and the Sync Monitoring Node.

It is possible to configure up to 1000 nodes for monitoring in the Sync Monitoring interface running on a standard LANTIME or IMS System. You can specify monitoring and logging intervals for each individual node separately. Besides, an offset limit can be configured for each node which triggers an alarm notification (via SNMP, email or a user defined channel) if the limit for this particular node is exceeded. For NTP nodes you can define also a stratum limit, which can also trigger an alarming when the defined limit is exceeded.

Moreover, for each node it is possible to download all the monitoring data and its log files which can be used to generate a report or for further statistical analysis. Data of each monitored node can be sent online via SYSLOG protocol with different formats or activate an "rsync" service to copy measured data to external data server. Online Data of each node can be read via WEB service like "curl" or "wget" in JSON format to use current data in other management systems.

A JSON file for each node is available under: `/www/htdocs/syncmon/[alias].json` where [alias] is a placeholder for the Node-Alias.

9.1.12.2 Sync Monitor first steps

When SyncMon is started for the first time, there is no monitoring activated. To activate monitoring at least one node has to be added. Press the button "Add Node" to add a new monitoring node.

9.1.12.3 Sync Monitor Status and Configuration via WEB Interface

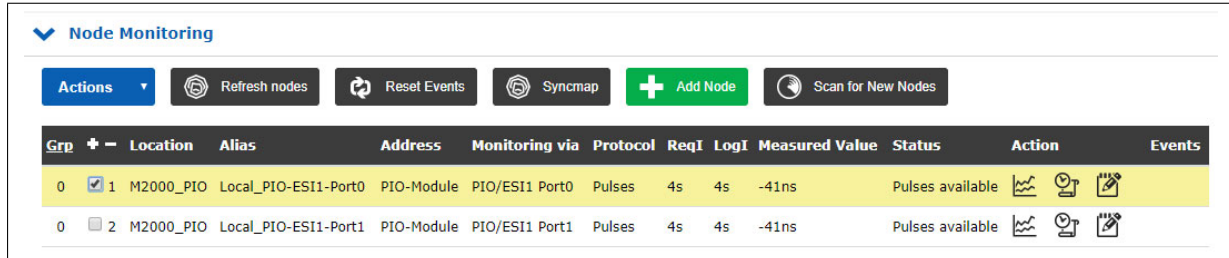

The screenshot shows the "Node Monitoring" section of the Sync Monitor web interface. At the top, there are several buttons: "Actions" (dropdown), "Refresh nodes", "Reset Events", "Syncmap", "Add Node" (green), and "Scan for New Nodes". Below these buttons is a table with the following columns: Grp, Location, Alias, Address, Monitoring via, Protocol, ReqI, LogI, Measured Value, Status, Action, and Events. The table contains two rows of data, both with a "0" in the "Grp" column.

| Grp | Location | Alias | Address | Monitoring via | Protocol | ReqI | LogI | Measured Value | Status | Action | Events |
|-----|-----------|----------------------|------------|----------------|----------|------|------|----------------|------------------|---------|---------|
| 0 | M2000_PIO | Local_PIO-ESI1-Port0 | PIO-Module | PIO/ESI1 Port0 | Pulses | 4s | 4s | -41ns | Pulses available | [Icons] | [Icons] |
| 0 | M2000_PIO | Local_PIO-ESI1-Port1 | PIO-Module | PIO/ESI1 Port1 | Pulses | 4s | 4s | -41ns | Pulses available | [Icons] | [Icons] |

Figure: Sync Monitor user interface on LANTIME systems with a FW 7.00 or later.

The "Node Monitoring" will show the current status and configuration of all monitored nodes. A monitoring node can be either a device in the network like NTP servers or PTP devices or an Lantime specific input module for e.g. Pulses or frequencies. Each line in the table represents a monitored node or a group of nodes. The table can be displayed in flat or group mode. In flat mode only nodes will be displayed in a line. To structure the table the group mode can be selected by clicking the "Grp" button in the first column – all nodes with the same number are grouped and can be opened separately.

The status on the WEB interface will be updated automatically every 10s. In the Sync Monitor Status and Configuration dialogue you can add new members for measuring their accuracy and monitoring their sync performance. By selecting a "+ Add Node" button you will proceed to an enter configuration dialog in order to add a new node for monitoring.

"Refresh Nodes" Button:

This can be used to get an overview of the current values just at that moment even if the request interval is higher. All configured nodes will be refreshed. A new measurement will be done and status in table of nodes will be updated. The refreshed value will be added to the list of measured values to calculate the median value. No measurement will be done on all HPS cards using PTP.

Figure: Add Node configuration dialog.

The features in the "Add Node" configuration dialog depend on the input selection of the first parameter "Monitoring via" and offer different input masks with different options:

Monitoring via:

Select a monitoring instance from the drop down list. The drop down list appears differently in different HW configurations. The following options are available:

Main CPU: This monitoring instance is always available and is not dependent on HW configuration of the LANTIME system. It can monitor native NTP nodes only, which are responding to NTP client requests (Note: A NTP client that is using the Windows Time Service W32Time does not respond to NTP client requests per default configuration. W32Time needs to be configured to act as client and server at the same time. Otherwise the node cannot be monitored via SyncMon). All assigned interfaces can be monitored at the same time or you can select a particular interface from a list if available.

The selection box "NTP Parameter Type" can be used to select whether the "NTP Offset", "NTP Stratum", "NTP Path Delay" or "NTP Root Dispersion" should be saved.

If several network interfaces are available, a specific interface or all interfaces can be selected via the "Monitoring Interface" selection box.

External SyncMon: This monitoring instance can monitor nodes and sensors of other Lantime devices with activated SyncMon. When selecting the external SyncMon with IP address a list of available nodes from that external SyncMon will be downloaded. Configuration and data will be transferred via WEB service (curl).

External Microsync: This can be used to monitor MRS references from external MicroSync devices. When selecting the external MicroSync with IP address, a list of available references is downloaded from this external MicroSync. Configuration and data are transferred via the WEB service (Curl).

HPS: HPS100 cards can be used for monitoring PTP or NTP on its own network port.

If HPS is configured (see Lantime PTP configuration) as PTP slave then the HPS card will behave like a standard PTP Slave with all its options like Profiles and network specific configurations - but only one PTP Master can be monitored at the same time with the HPS card.

If HPS is configured (see Lantime PTP configuration) as monitoring device (this is only possible if HPS has a 1024 clients license at minimum) then multiple PTP nodes can be monitored with the network port of the HPS card. Then that monitoring instance can monitor PTP nodes, supporting protocols PTP with TLV (proprietary for a Meinberg Sync Node), PTP with MGMT (defined in the IEEE 1588v2 standard) and NTP with software time stamping.

The special protocol "PTP with TLV" is like a reverse PTP: a PTP delay request packet with a special TLV will be send to the PTP device and this will answer with a sync packet and a delay response packet – this method allow measuring the offset from the internal reference to the PTP device even if the PTP device is in Master, Slave or Passive mode.

Statistic Types:

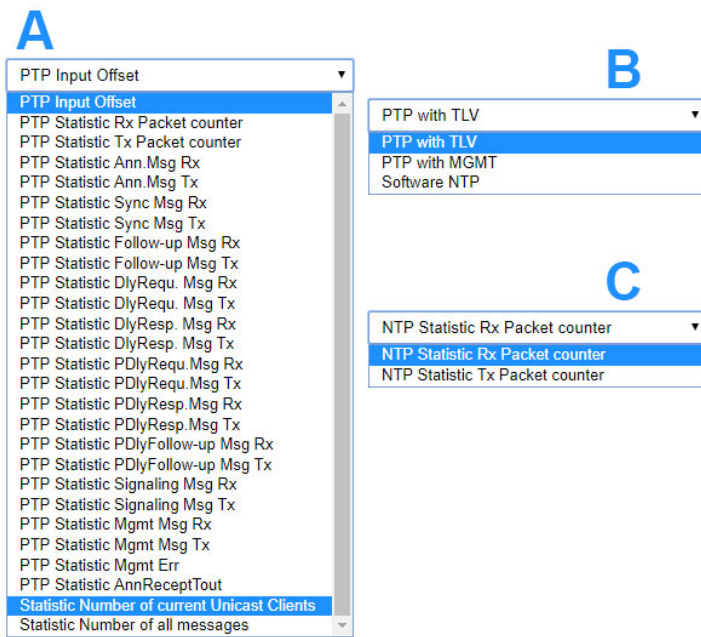

HPS cards in PTP or NTP mode support packet statistics which can be monitored individually:

- A: HPS in PTPv2 Operating Mode.
- B: HPS in Monitoring Mode.
- C: HPS in NTP Mode.

- ESI:** This monitoring instance can monitor PPS and Freq nodes with Extension Signal Input (ESI) card. From a drop down list you can select which particular signal you wish to monitor. Options available are: PPS0, Freq In0, Freq In1, BITS In2.
- MRS-CLK:** This monitoring instance can monitor all activated MRS input signals for each MRS-reference clock. From a dropdown list you can select which signal you want to monitor. Options available are: GNSS/ GPS, NTP, PTP, PPS, IRIG, 10MHz, E1, 2048kHz, - (depending on HW options (see "Clock" tab in the Web interface).
- PIO:** This monitoring instance can monitor PPS and Freq nodes with Programmable Input Output (PIO) card. From a drop down list you can select which particular signal you wish to monitor. This depends on the configuration of the PIO card. Options available are: PPS0, PPS1, PPS2, PPS3, Freq In0, Freq In1, Freq In2, Freq In3.
- FDM:** This monitoring instance can monitor 50/60Hz power line networks nodes with Frequency Deviation Monitor (FDM) card. From a drop down list you can select which particular signal you wish to monitor. Options available are: time deviation or frequency deviation.

Special Parameters:

This monitoring instance can monitor various parameters if they are enabled:

Process Memory:

This can be used to monitor the memory usage of system processes. For this purpose, the name of the process must be specified and the values are displayed in %.

After selecting "Special Parameters → Process Memory" the following fields change:

NTP Parameter Type → **Special Parameter** and
Address (IPv4/IPv6 or MAC) → **Name of Process**.

Here, the process name must be entered in the field "Name of process", which could be **ntpd** or **httpd**, for example. Via SSH, you can display a list of the executed processes with the command `'ps ax'`. The process names are also displayed here.

ID of selected HPS card:

This option is only offered if a HPS card is active in the system as PTP slave. If several HPS cards are present in the system as PTP slave, then the best card is selected via the internal PTP BMCA (Best Master Clock Algorithm) and used as MRS/PTP reference. With this parameter the selected ID of the card can be monitored.

ID of selected NTP server:

This option is only offered if external NTP servers have been configured in the system. If several external NTP servers are configured, then the best external NTP server is selected via a special NTP selection procedure and used as MRS/NTP reference. With this parameter the selected ID of the external NTP servers can be monitored.

Address (IP4/6 or MAC):

IPv4 or IPv6 or MAC address of a node you want to monitor over the network. Host names are not allowed.

Alias:

Alias name for a monitoring node to find it easily in the complete table overview. The alias name which is configured by the user will define the name of the directory on flash disc ('Base Path for logfiles for history of days') of each node. The alias name has to be unique and one word without blanks with a maximum length of 63 characters (blanks will be converted to '_' automatically). It is possible to monitor the same node (e.g. the same IP-address) with different alias names – this may be useful if you want to monitor the same node from different monitoring modules (e.g. different HPS100 IMS cards with separate network paths).

Location:

Enter a physical location of a monitoring node for you to recognize this node easily in the complete table. The location name has to be one word without blanks with a maximum length of 63 characters (blanks will be converted to '_' automatically).

Group Index:

You can group monitored nodes within a logical group by assigning them the same index, (e.g. nodes with the same group index may be of the same kind (NTP, PTP, PPS), or at the same location, etc.). Nodes with the same group index will be sorted automatically in the table. The table can be displayed in flat or group mode. In flat mode only nodes will be displayed in a line. To structure the table the group mode can be selected by pressing the "Grp" button on top of the first column – then all nodes with the same group number will be gathered to one line and can be opened separately.

Request Interval (s):

Interval in seconds by which a monitoring node sends monitoring requests to the slaves / clients. The min request interval is 1s, the max is 3600s. A default interval is 64s. If the Request Interval is disabled (0) then no requests will be sent to the nodes and no data will be logged.

Logging Interval (s):

Interval in seconds by which the measured offset and stratum are written to a logfile. If the log-interval is disabled then no data will be stored to the logfile. If the request interval has been activated and the log-interval has been disabled then the nodes will be monitored and limits and notifications will be checked but no data will be stored. If the Request Interval is lower than the Logging Interval then the mean value of the measured offsets at request interval will be logged and the Minimum and Maximum values in the log-interval will be stored additionally.

Fix Offset [s]:

A certain offset is known for some network nodes (e.g. network asymmetry). This value serves as a correction value and can be entered here. The "Fix Offset" is always added to the "Measured Value". An entered fixed offset is displayed in the overview with a * in the "Measured Value" column.

Disable Monitoring:

Monitoring can be disabled for each node. If Node has been disabled then no monitoring Data will be send to the Node and no data will be saved.

Disable Logging on external Server:

The measured or logged data can be send via SYSLOG or RSYNC protocol to an external server. This can be disabled for each node (see System settings for external Server Configuration).

9.1.12.4 Actions Button

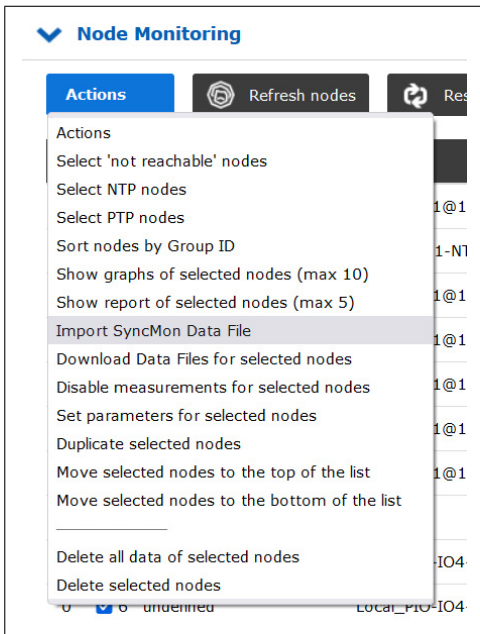

The "Actions" button can be used to systematically select certain nodes in the SyncMon node list and perform certain operations on them, and to rearrange the list order:

- Select 'not reachable nodes':** Selects all nodes that are not reachable.
- Select NTP nodes:** Selects all nodes sending or receiving NTP messages.
- Select PTP nodes:** Selects only PTP grandmasters or slaves.
- Sort nodes by Group ID:** Sorts nodes in ascending order by Group ID.
- Show graphs of selected nodes:** Displays the graphs for the selected nodes (max. 10).
- Show report of selected nodes:** Displays the reports for the selected nodes (max. 5).
- Import SyncMon Data File:** Imports nodes and data from a data file.
- Download Data Files for selected nodes:** Generates a data file for the selected nodes.
- Disable measurements for selected nodes:** Disables monitoring for the selected nodes.
- Set parameters for selected nodes** Allows the parameters for several selected nodes to be configured simultaneously.
- Duplicate selected nodes:** Duplicates the selected nodes.
- Move selected nodes to the top of the list:** Moves the selected nodes to the top of the list.
- Move selected nodes to the bottom of the list:** Moves the selected nodes to the bottom of the list.

| | |
|---|---|
| Delete all data of selected nodes: | Deletes all of the data (graphs and error logs) related to the selected nodes. |
| Delete selected nodes: | Deletes all of the selected nodes. |
| Show overview for current day: | <p>Displays a status overview of each node shown in the list, including measured and reported offsets and the last error recorded. Also provides access to graphs and error logs for each node.</p> <p>This option is only displayed if no nodes are selected.</p> |
| Show overview for time range: | <p>Prompts you to specify a time range for the overview. If <i>Add SyncMap to Report</i> is checked, the overview will incorporate a copy of the current SyncMap.</p> <p>Once the time range is specified, a status overview of each node shown in the list will be displayed, including measured and reported offsets and the last error recorded. Graphs and error logs can also be accessed for each node.</p> |

9.1.12.5 Exporting and Importing Data in SyncMon

The Export/Import function can be used to export data for selected nodes over a specific period of time. The daily data files are packaged in a downloaded archive (.tgz). The export function "Download Data Files for selected Nodes" is located in the "Actions" menu, provided that at least one node has been selected. You will then be prompted to enter a time period for which the data should be stored. The names of the .tgz files follow the format below:

```
lt_syncmon_data_ + hostname + number of files included + date + time
```

Example:

```
lt_syncmon_data_timeserver_6files_20220311_070714.tgz
```

The .tgz file includes all data files for the selected nodes over the selected period. Each node is represented by a directory with the alias name. The archive also includes the relevant files for the local clock and node configuration files. The number of included files specified in the download name only relates to the number of data files for the nodes and local clock.

Example of directory structure for an unpacked .tgz file:

```
172.27.100.57/  
----> ntp_mon_stats.20220314  
----> ntp_mon_stats.20220315  
----> ntp_mon_stats.20220316  
local_reference/  
----> ntp_mon_stats.20220314  
----> ntp_mon_stats.20220315  
----> ntp_mon_stats.20220316  
-----> syncmon_selected_nodes.cfg  
-----> syncmon_selected_system_monitoring.cfg
```

This .tgz file can then be imported to any system with SyncMon—including other LANTIME systems—using the menu item "Import SyncMon Data File". This enables the exported data to be compared directly with other data from SyncMon-equipped systems.

9.1.12.6 External SyncMon

"External SyncMon" is a special monitoring instance that can monitor nodes and sensors of other LANTIME devices with activated SyncMon. When selecting the external SyncMon with IP address a list of available nodes from that external SyncMon will be downloaded. Configuration and data will be transferred via WEB service (curl).

Press "**Connect to external SyncMon**" will try to connect to the external SyncMon and show the SSL-Fingerprint of that server. Check the following ssl-fingerprints received from external SyncMon. The SSL certificates will be used by curl when https is active. To check the fingerprints open a SSH session on the external SyncMon and compare the output of: "openssl x509 -noout -fingerprint -sha256 -inform pem -in /etc/https.pem". This is to make sure that this is the correct device.

Then enter username and password to read Config from external SyncMon – the current configuration of external SyncMon will be read via *'curl'*. Also you have to configure the WEB access protocol (HTTP or HTTPS) and if you want to use a CA Certificate Bundle to get configuration and measured data from the external SyncMon.

Be aware that if you use HTTPS that all data has to be encrypted and decrypted which costs a lot of CPU-UTILIZATION for each data requesting from the external SyncMon.

Be aware if you want to use HTTP access protocol then you have to activate HTTP network service on the internal and external Lantime. The same is with the HTTPS protocol.

Configure External SyncMon Node

Found configuration on external SyncMon at 172.27.100.219

Location

Group Index
 [* = already in use]

| Select | Alias | IP Address | Monitoring via | Protocol | ReqI | LogI |
|-------------------------------------|-------|-------------------------|----------------|-------------------|-----------------|-----------|
| <input type="checkbox"/> | 1 | PTP_172.27.101.218_TLV | 172.27.101.218 | HPS in IO1 | PTP/TLV | 4s 8s |
| <input checked="" type="checkbox"/> | 2 | PTP_172.27.101.218_MGMT | 172.27.101.218 | HPS in IO1 | PTP/MGN | 4s 8s |
| <input checked="" type="checkbox"/> | 3 | PTP_BAD:BABE::A9AA_TLV | BAD:BABE::A9AA | HPS in IO1 | PTP/TLV | 4s 8s |
| <input checked="" type="checkbox"/> | 4 | PTP_172.27.19.68_TLV | 172.27.19.68 | HPS in IO1 | PTP/TLV | 4s 8s |
| <input type="checkbox"/> | 5 | PTP_172.27.19.68_MGMT | 172.27.19.68 | HPS in IO1 | PTP/MGN | 4s 8s |
| <input type="checkbox"/> | 6 | M600_100-32_V6-24-015 | 172.27.100.32 | Main CPU | NTP/SW | 4s 8s |
| <input type="checkbox"/> | 7 | M300_100-70_V6-24-019 | 172.27.100.70 | Main CPU | NTP/SW | 4s 8s |
| <input type="checkbox"/> | 8 | M3000_Q7_101-11_V7 | 172.27.101.11 | Main CPU | NTP/SW | 4s 8s |
| <input type="checkbox"/> | 9 | 172.27.100.57 | 172.27.100.57 | Main CPU | NTP/SW | 4s 8s |
| <input type="checkbox"/> | 10 | ESI-direct | ESI-Module | ESI1 with GPS0 | Pulses | 4s 8s |
| <input type="checkbox"/> | 11 | Local_CLK1-PPS | MRS-Module | MRS-CLK1 with PPS | MRS-Input | 4s 8s |
| <input type="checkbox"/> | 12 | HPS_in_MRI2 | 172.27.19.17 | HPS in IO2 | PTP/TLV | 4s 8s |
| <input type="checkbox"/> | 13 | bad:babe::a9f2_NTP | bad:babe::a9f2 | Main CPU | NTP/SW | 4s 8s |
| <input type="checkbox"/> | 14 | Local_NTP | Sensor | Local NTP | Local NTP | 8s 64s |
| <input type="checkbox"/> | 15 | Local_CPU-Utilization | Sensor | CPU-Utilization | CPU Usage | 8s 16s |
| <input type="checkbox"/> | 16 | Local_CPU-Temperature | Sensor | CPU-Temperature | CPU Temperature | 128s 128s |

Getting the current configuration from the external SyncMon you have to choose the nodes which you want to monitor of that Lantime. Only nodes will be offered which are not disabled and not disabled for external logging. The parameters for request and log interval will be take over from the external configuration. Location and the Group index can be configured for all selected nodes. The default Location will be "SyncMon-" plus the IP address. The Alias names for the external SyncMon nodes will be the original Alias-name plus "@IP-address". It is recommend to use a non used Group Id for all nodes of an external SyncMon.

Node Monitoring

Actions

| Grp | Location | Alias | Address | Monitoring via | Protocol | ReqI | LogI | Measured Value | Status | Action | Events |
|-----|------------------------|------------------------|--------------------------------------|----------------|------------------|-----------|-------|-----------------------------|----------------|--------|--------|
| 0 | undefined | Group 0 with 2 Members | | | * | * | * | -49.08us ... 2ns | | | 1 |
| 1 | undefined | Group 1 with 1 Member | | | * | * | * | 102ns ... 102ns | | | 1 |
| 3 | SyncMon-172.27.100.219 | Group 3 with 3 Members | | | * | * | * | ambiguous | | | 3 |
| 3 | 4 | SyncMon-172.27.100.219 | PTP_172.27.19.68_TLV@172.27.100.219 | 172.27.100.219 | External SyncMon | HPS Input | 4s 8s | -86ns / [+10.00us] [MinMax] | Slave / Dom:19 | | |
| 3 | 5 | SyncMon-172.27.100.219 | PTP_172.27.19.68_MGMT@172.27.100.219 | 172.27.100.219 | External SyncMon | HPS Input | 4s 8s | 111ns / [+1.000us] [MinMax] | Slave / Dom:19 | | |
| 3 | 6 | SyncMon-172.27.100.219 | M600_100-32_V6-24-015@172.27.100.219 | 172.27.100.219 | External SyncMon | MainCPU | 4s 8s | -40.30us [MinMax] | Stratum:1 | | |

If changes will be done on that nodes of external SyncMon configuration which will be monitored then a warning sign will be displayed in the main table in the **Event** column for that node. Then you have to change parameters manually for that node.

Node Monitoring

Actions | Reset Events | Syncmap | Add Node | Scan for New Nodes

| Grp | Location | Alias | Address | Monitoring via | Protocol | ReqI | LogI | Measured Value | Status | Action | Events |
|-----|---------------------------------------|------------------------|--------------------------------------|----------------|------------------|-----------|-------|-----------------------------|----------------|--------|--------|
| 0 | undefined | Group 0 with 2 Members | | | | * | * | -49.30us ... -27ns | | | 1 |
| 1 | undefined | Group 1 with 1 Member | | | | * | * | 142ns ... 142ns | | | 1 |
| 3 | SyncMon-172.27.100.219 | Group 3 with 3 Members | | | | * | * | ambiguous | | | 3 |
| 3 | <input checked="" type="checkbox"/> 4 | SyncMon-172.27.100.219 | PTP_172.27.19.68_TLV@172.27.100.219 | 172.27.100.219 | External SyncMon | HPS Input | 4s 8s | 229ns / [+10.00us] [MinMax] | Slave / Dom:19 | | |
| 3 | <input checked="" type="checkbox"/> 5 | SyncMon-172.27.100.219 | PTP_172.27.19.68_MGMT@172.27.100.219 | 172.27.100.219 | External SyncMon | HPS Input | 4s 8s | -20ns / [+1.000us] [MinMax] | Slave / Dom:19 | | |
| 3 | <input checked="" type="checkbox"/> 6 | SyncMon-172.27.100.219 | M600_100-32_V6-24-015@172.27.100.219 | 172.27.100.219 | External SyncMon | MainCPU | 4s 8s | -44.28us [MinMax] | Stratum:1 | | |

9.1.12.7 External MicroSync

External MicroSync is a special monitoring instance that can monitor MRS references from external MicroSync devices. When selecting the external MicroSync with IP address, a list of available MRS references is downloaded from this external MicroSync.

Configuration and data are transferred via the WEB service (Curl).

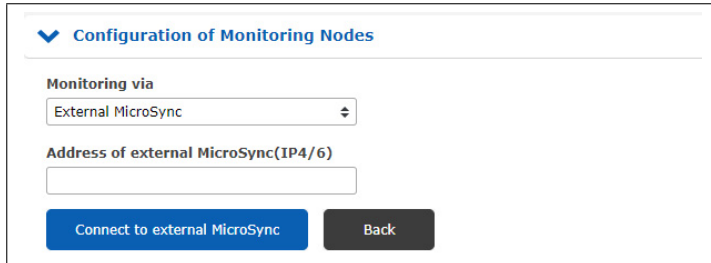

Configuration of Monitoring Nodes

Monitoring via
External MicroSync

Address of external MicroSync(IP4/6)

Connect to external MicroSync Back

Press "Connect to external MicroSync", this will make the system try to connect to the external MicroSync and display the SSL fingerprint of this server. Check the following SSL fingerprints received from external SyncMon. The SSL certificates are used by curl. To verify the fingerprints, open an SSH session on the external MicroSync and compare the output of:

```
openssl x509 -noout -fingerprint -sha256 -inform pem -in /etc/https.pem
```

This ensures that it is the correct device.

Then enter username and password of the MicroSync system to read the configuration from the external MicroSync - the current configuration of the external MicroSync is read via 'curl'. Note that when using HTTPS, all data must be encrypted and decrypted, which causes a lot of CPU usage for each data request to the external MicroSync system.

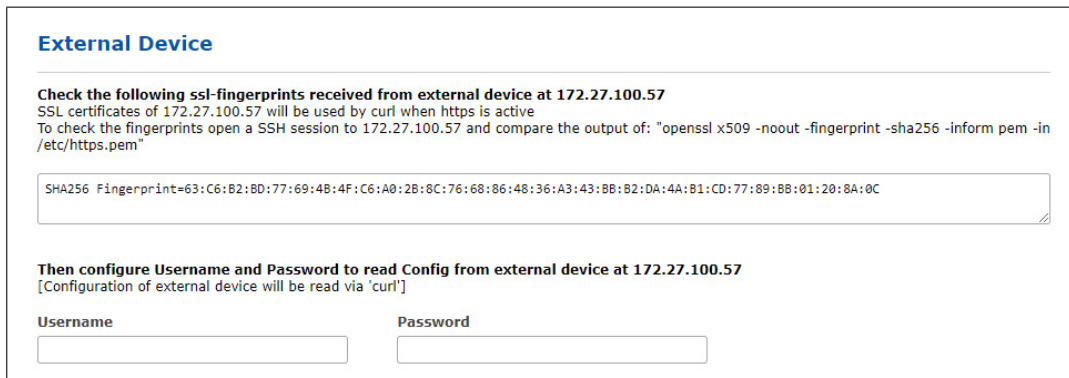

External Device

Check the following ssl-fingerprints received from external device at 172.27.100.57
SSL certificates of 172.27.100.57 will be used by curl when https is active
To check the fingerprints open a SSH session to 172.27.100.57 and compare the output of: "openssl x509 -noout -fingerprint -sha256 -inform pem -in /etc/https.pem"

SHA256 Fingerprint=63:C6:B2:BD:77:69:4B:4F:C6:A0:2B:8C:76:68:86:48:36:A3:43:BB:B2:DA:4A:B1:CD:77:89:BB:01:20:8A:0C

Then configure Username and Password to read Config from external device at 172.27.100.57
[Configuration of external device will be read via 'curl']

Username

Password

To get the current configuration from the external MicroSync you have to select the MRS references you want to monitor from this LANTIME. The parameters for request and log interval are set the same for all of them.

The location and group index can be configured for all selected MRS references. The default location is *MicroSync-** plus the IP address by default.

The alias names for the external MicroSync MRS references are the original alias name plus @IP address. It is recommended to use an unused group ID for all MRS references of an external MicroSync.

Configure External MicroSync Node

Found configuration on external MicroSync at 172.28.41.2

Location

Group Index
 [* = already in use]

Request Interval [s] **Logging Interval [s]**

| Select | Alias | Status |
|--------------------------|-------------------------|---|
| + - | | |
| <input type="checkbox"/> | 1 GPS1-CLK1 | Is-Master -Is-Locked -Is-Accurate -Low-Jitter |
| <input type="checkbox"/> | 2 TCR1-CLK1 | |
| <input type="checkbox"/> | 3 PPS1-CLK1 | |
| <input type="checkbox"/> | 4 PTP1-CLK1 | |
| <input type="checkbox"/> | 5 FIXED_FREQ1-CLK1 | |
| <input type="checkbox"/> | 6 STRING-PPS1-CLK1 | |

Add Selected Nodes

When changes are made to the nodes of the external MicroSync configuration that are to be monitored, a warning sign is displayed in the Events column for this node in the main table. Then you have to change the parameters for this node manually.

| | | | | | | | | |
|---|-----------------------------|--|-------------|--------------------|-------------|------------|----------|--|
| 0 | <input type="checkbox"/> 25 | MicroSync-172.28.41.2 PPS1-CLK1@172.28.41.2 | 172.28.41.2 | External MicroSync | MainCPU/NTP | 64s 64s | +46.50us | |
|---|-----------------------------|--|-------------|--------------------|-------------|------------|----------|--|

9.1.12.8 Event Configuration

Event Configuration

| | |
|---|--|
| Offset Limit [s] 0.000000000 | Trigger Trigger if Limit Exceeded |
| Offset Limit [s] Trigger Counter 0 Number of limit exceedings before sending an alarm | Stratum Limit Trigger Counter 0 Number of limit exceedings before sending an alarm |
| Stratum Limit 0 | Not Reachable Trigger Counter 0 Number of limit exceedings before sending an alarm |
| Not Reachable Event Disabled | |

Offset Limit (s):

Offset threshold value in seconds. The measured offset between a node and the reference will be compared to the configured threshold. If the calculated difference is higher than the configured offset limit the LANTIME will generate an alarm "Sync Monitor" (which can be sent as a notification eMail, SNMP trap or to an external syslog server). With the "Trigger" option can be choose the direction "Trigger if Limit Exceeded" or "Trigger if Below Limit". With the option "Offset Limit [s] Trigger Counter" the Event will be triggered once after number of limit exceeded in a row.

Stratum Limit:

Threshold value for a NTP stratum level. If the stratum level of a monitored client is higher than the configured stratum limit, it will generate an alarm (sent by eMail, SNMP trap or to an external syslog server). With the option "Stratum Limit Trigger Counter" the Event will be triggered once after number of limit exceeded in a row.

Not Reachable Event:

If configured Node is not reachable for monitoring then LANTIME will generate an alarm "Sync Monitor" (which can be sent as a notification eMail, SNMP trap or to an external syslog server). With this option this can be enabled or disabled. With the option "Not Reachable Limit Trigger Counter" the Event will be triggered once after number of not reachable exceeded in a row.

9.1.12.9 Symmetric Key Configuration

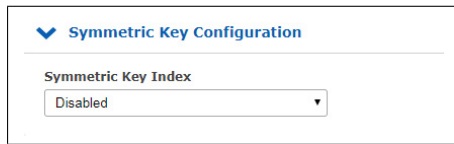

Symmetric Key Configuration
 Symmetric Key Index
 Disabled

Symmetric Key Index:

If you want to use symmetric key authentication for SyncMon then select a key index from the list of already applied keys. If the keys are not yet defined, proceed to the NTP dialog in the "Web GUI → NTP → Symmetric Keys" and generate a new key file, which should be stored and activated on the monitored node as well. For more information about Symmetric Key Generation please proceed to LTOS7 Configuration "Web GUI → NTP → NTP Symmetric Keys".

9.1.12.10 Graph Configuration

Asymmetry Offset for Graphic:

If a constant asymmetry of the measured nodes is known then you can set this value for the graphical output – the logged values will not be modified – the asymmetry offset is like a fix offset for graphic monitoring only.

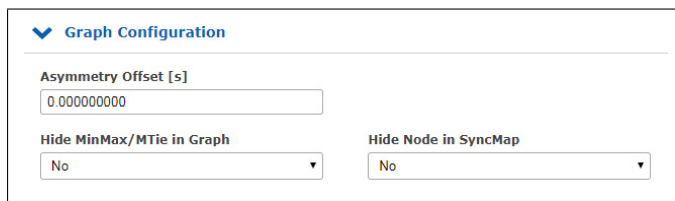

Graph Configuration
 Asymmetry Offset [s]
 0.00000000
 Hide MinMax/MTie in Graph: No
 Hide Node in SyncMap: No

Hide Min/Max/MTie filled curves in Graphic:

If the request-interval is lower than the log-interval additional values for Min and Max will be stored in the logfiles. These Min/Max values will be displayed as a filled curve in a gray color behind the logged offset curve. This feature can be disabled.

Hide this Node in SyncMap:

You can disable a specific node in the SyncMap.

When you are finished with configuration of a new monitored node, save the current configuration by clicking the "Save Member" button. By clicking the "Remove Member" button you will remove the currently selected node from the complete list of all monitored nodes. All sampled data for the particular node will be lost if you did not back-up the saved data prior its removal.

By clicking the "Remove Existing Data" button all data for only this specific node will be erased.

9.1.12.11 Scan for New Nodes

Scan for new Nodes is an automatic search for NTP and PTP nodes within your network. Scan for PTP nodes will be supported by HPS card only with 1024 clients license and monitoring activated.

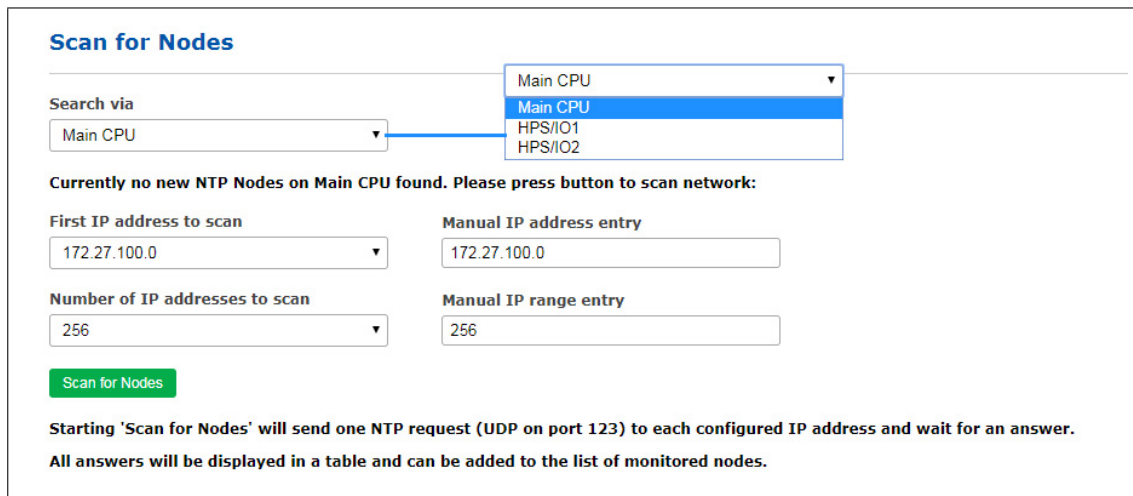

Figure: Scan for new Nodes dialog. Only newly found nodes will appear in this temporary table. Select nodes which you wish to add in the overall monitoring node table.

Search via:

First select an instance from a drop-down list to use for searching of new nodes. Possible options are "Main CPU" and "HPS" card. With the Main CPU you can search for NTP nodes only. Scan for PTP nodes will be supported by HPS card only with 1024 clients license and monitoring activated.

First IP address to scan:

Set the starting IP Address where the search will start with the automatic NTP scan. In the drop-down list you will find all sub net ranges of each network interface. With "Manual IP address entry" an other start point can be defined.

Number of IP Address to scan:

This parameter will set a number of IP-addresses which will be scanned. To each IP address from the IP-Range a separate NTP packet request will be sent. If a NTP client answers to this request and its IP address has not yet been configured then this node will appear in the table. With "Manual IP range entry" an other size of the range can be defined.

Scan for NTP Nodes via Main CPU:

Starting "**Scan for Nodes**" will send one NTP request (UDP on port 123) to each configured IP address (IP address range) and wait for an answer.

All answers will be displayed in a table and can be added to the list of monitored nodes. With select-boxes new nodes can be added automatically to the list of the monitored nodes. The parameters for Location, Group Index, Request Interval, Logging Interval, Offset Limit and Stratum Limit can be defined at the next step, before adding them in the table with other monitored nodes.

Search via HPS:

If a HPS card in monitoring mode (supported by HPS card only with 1024 clients license and monitoring activated) is selected then the "PTP Domain" has to be set up.

Scan for Nodes

Search via

Currently no PTP Nodes on HPS in IO1 found. Please press button to scan network:

PTP Domain

Starting 'Scan for Nodes' will send 3 PTP Management requests (with the commands 'port','clock' and 'current') as IPv4-, IPv6- and Layer2-Multicast to the configured PTP-Domain number and wait for answers.
 All answers will be displayed in a table and can be added to the list of monitored nodes.

Figure: To scan the network for PTP nodes a HPS card with activated monitoring has to be selected first in the Search for Nodes drop-down list.

PTP Domain:

The network connected to that HPS card will be scanned in the domain, which was defined here by user. The following mappings as defined in IEEE 1588-2008 will be scanned:

- UDP/IPv4/Ethernet,
- UDP/IPv6/Ethernet,
- Ethernet (IEEE 802.3, layer 2).

When starting the scan first a PTP Management message will be sent in broadcast mode to get the "port state" of each PTP node - this will be done with IPv4, IPv6 and Layer2.

All PTP nodes which answer to this request will ask for the "current status" and "clock status" with management messages that follow. The result will be displayed as a list of all available PTP nodes. Each new PTP Node will be entered in an overview table of the available nodes.

Only new nodes which have not yet been configured will be shown in the table. For each node the PTP-UUID, MAC-Address, IP-Address, Vendor name, Feature (if a node supports PTP with extended TLV for monitoring or PTP management messages only), Domain number, Status (the current PTP status like Slave, Master, Listening . . .), Offset and Delay (current measured values from PTP management message) will be automatically displayed in the table. With select-boxes new nodes can be added automatically to the list of the monitored nodes. The parameters for Location, Group Index, Request Interval, Logging Interval, Offset Limit and Stratum Limit can be defined in the next step before adding the selected nodes.

New Node Configuration

Location

Group Index
 [* = already in use]

Request Interval [s]

Logging Interval [s]

Offset Limit [s]

Stratum Limit

| Select | IP Address |
|-------------------------------------|-------------------|
| <input checked="" type="checkbox"/> | 1 172.27.100.0 |
| <input checked="" type="checkbox"/> | 2 172.27.100.32 |
| <input checked="" type="checkbox"/> | 3 172.27.100.39 |
| <input checked="" type="checkbox"/> | 4 172.27.100.42 |
| <input checked="" type="checkbox"/> | 5 172.27.100.44 |
| <input checked="" type="checkbox"/> | 6 172.27.100.57 |
| <input type="checkbox"/> | 7 172.27.100.70 |
| <input type="checkbox"/> | 8 172.27.100.75 |
| <input type="checkbox"/> | 9 172.27.100.95 |
| <input checked="" type="checkbox"/> | 10 172.27.100.105 |
| <input checked="" type="checkbox"/> | 11 172.27.100.109 |

The monitoring engine will start to send PTP/NTP requests in the configured intervals to each node from the list and measure the time received in the responses with its own time (which is traceable to UTC, GNSS sync for example). The current offset and status information can be checked in the status overview table in the Node Monitoring menu.

In the status overview table of monitored nodes, next to the status information you will find 3 action buttons: Graph, Error Logs and Edit.

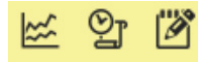

By selecting the Graph button a Graphical Diagram for the selected node will show up. At this page you find several features for different representation options.

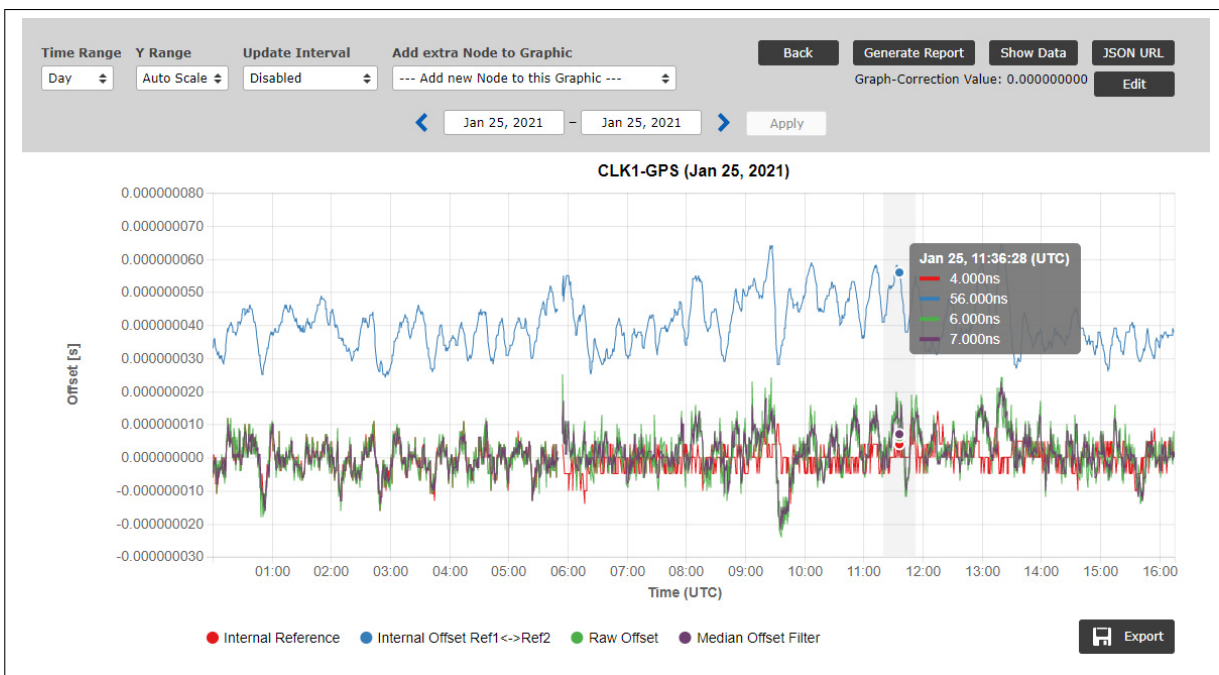

Figure: Graphical diagram of offset values for each node, selectable for different time ranges (day, week, month or manual selection). With given buttons at the "Select Time Range" you can select either past or future intervals for the graphical representation.

Offsets are collected for each NTP/PTP or other monitored node and can be depicted as graphical representation for selectable time intervals in the web UI of the SyncMon node.

The monitored data are continuously saved on the Sync node "Base Path for logfiles for current day" and will be saved automatically to the Flash Card ('Base Path for logfiles for history of days') at change of a day at 0:00 UTC. Data are available at any time for further statistic processing.

At the bottom of the graph an overview will show which color will represent which data. In this case the red line represents the internal NTP Offset, which is the reference for the monitored NTP node. The green line is the offset between a Sync node reference time and the measured time of a monitored device.

● Min-Max ● Internal NTP Offset ● Internal Offset Ref1<->Ref2 ● Raw Offset ● Median Offset Filter

By positioning the cursor to one item in the bottom line then only that graph will be displayed and all other graphs will be shown in light color. When clicking to one item in the bottom line then this graph will be hidden.

For PTP and PPS signals, the sync node reference is an internal reference time from the receiver (e.g. multi GNSS (GPS, GLONASS, Galileo, Beidou), external UTC time service, IRIG TC, long wave time reference: eg. PZF, MSF, WWVB . . .). The sync node reference is depicted as a red line and if a second reference is available then the blue line represents the offset between the two referenc clocks. For multi GNSS reference clock in normal operation you will see something in the lower nano second range with 5ns resolution.

For NTP monitored signal the Sync node is synchronized the internal NTP that is in sync by an internal reference clock (multi GNSS or IRIG TC, long wave ...). In this case the red line in the graph represents the internal NTP system time.

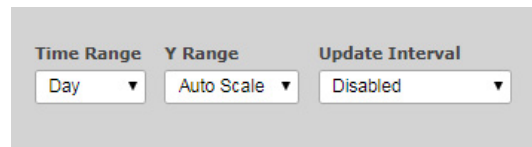

Time Range:

There are different time ranges to choose from. By day, week, month and custom. When selecting the custom time range click on "Apply" to display the graph with the selected time range. For other options it is also possible to go back to see data in the past.

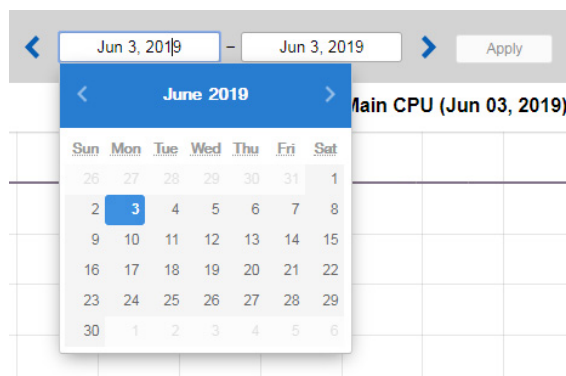

Y Range:

Different options available: auto-scale, or fixed Y ranges in decade intervals: 100ns, 1us, 10us, 100us, 1ms, 10ms and 100ms.

Update Interval:

Automatically update of the current graph can be activated from 1s up to 1 hour.

For NTP nodes it is possible to view a graph either as raw data or with applied Median Filter or a graph of the internal reference only (the red line).

For PTP nodes, selected graph modes are **Reported offset from a PTP node** (data obtained from a PTP node by a standard MGMT protocol).

Measured offset to a PTP node (offset of a PTP slave measured against the internal reference). The measurements are available only for PTP nodes which support monitoring PTP protocol with TLVs. The monitored node can be in Slave, Master or Passive mode. Along with the measured values obtained by reverse PTP, also reported value curve is available and MTIE filled curve if MIN and MAX value measurement is supported on the monitored node.

For PPS nodes monitored via an ESI or PIO input card at the Sync node, you will have the graph modes available: raw data, data with applied Median Filter and Internal Reference only (a PPS from an internal reference clock.)

If the request-interval is less than the log-interval then additional Min-Max values for that log-interval will be stored in the data files. These Min-Max values will be added automatically as a filled curve in the graphical diagram and the mean value will be shown as red line in that filled Min/Max curve.

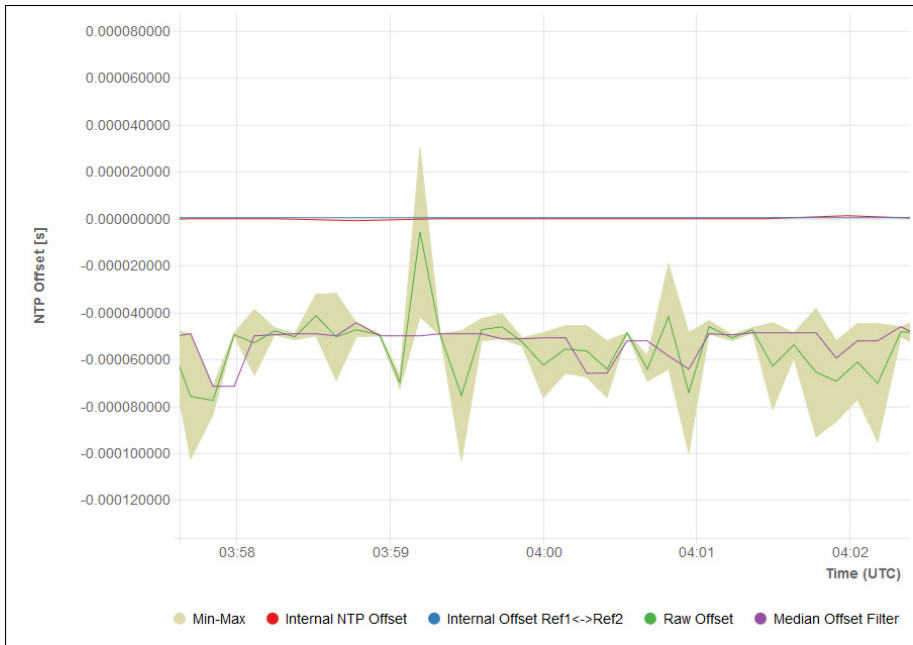

Zoom X/Y-Range:

To zoom in and out the Y-Range position the mouse cursor on the Y-axis and scroll with the mouse wheel to zoom in and out. When pressing the mouse button once on the Y-axis this will be reset to the selected Y-Range. When pressing the mouse button and moving the mouse up and down the Y-axis will be moved up and down.

To zoom in and out the X-Range (time line) position the mouse cursor in the graph and scroll with the mouse wheel to zoom in and out. When pressing the mouse button and moving the mouse left and right the graph will be moved left and right. By moving the mouse over the graph an info view will show all values of all graphs.

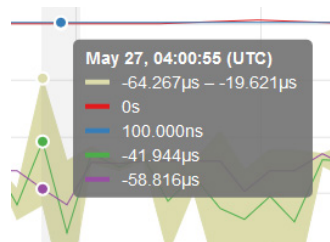

Show Data:

With the Button "Show Data" you can swap the graphic to a table view of the current displayed values. The first line will show the description of each column. With the "Show Graph" button you can go back to the graphical view. If zoomed in then data will be shown of the zoomed time range only.

Time Range: Y Range: Update Interval:

Back Generate Report Show Graph JSON URL

Asymmetry Measured Offset [s]: 0.000000000
Asymmetry Reported Offset [s]: 0.000000000

Edit

< - >

| # | Day | Sec | Julian_day_time | Meas_offset | Report_offs | Path_delay | Port_state | Min | Max |
|-------|-------|-----|---------------------------|--------------|--------------|-------------|------------|--------------|-------------|
| 58638 | 00002 | | 2019-06-04T00:00:02+00:00 | -0.000000002 | 0.00000173 | 0.000009348 | 9 M | -0.000000876 | 0.000000578 |
| 58638 | 00010 | | 2019-06-04T00:00:10+00:00 | 0.000000078 | 0.000000055 | 0.000009064 | 9 M | -0.000000876 | 0.000000578 |
| 58638 | 00018 | | 2019-06-04T00:00:18+00:00 | -0.000000087 | -0.000000001 | 0.000009067 | 9 M | -0.000000876 | 0.000000578 |
| 58638 | 00026 | | 2019-06-04T00:00:26+00:00 | 0.000000234 | 0.000000152 | 0.000009123 | 9 M | -0.000000876 | 0.000000578 |
| 58638 | 00034 | | 2019-06-04T00:00:34+00:00 | 0.000000497 | 0.000000104 | 0.000009059 | 9 M | -0.000000876 | 0.000000578 |
| 58638 | 00042 | | 2019-06-04T00:00:42+00:00 | 0.000000084 | -0.000000147 | 0.000009064 | 9 M | -0.000000876 | 0.000000578 |
| 58638 | 00050 | | 2019-06-04T00:00:50+00:00 | 0.000000334 | -0.000000237 | 0.000009015 | 9 M | -0.000000876 | 0.000000578 |
| 58638 | 00058 | | 2019-06-04T00:00:58+00:00 | 0.000000136 | -0.000000306 | 0.000009015 | 9 M | -0.000000276 | 0.000000352 |
| 58638 | 00066 | | 2019-06-04T00:01:06+00:00 | 0.000000247 | -0.000000230 | 0.000008820 | 9 M | -0.000000276 | 0.000000352 |
| 58638 | 00074 | | 2019-06-04T00:01:14+00:00 | 0.000000117 | 0.000000124 | 0.000008703 | 9 M | -0.000000276 | 0.000000352 |
| 58638 | 00083 | | 2019-06-04T00:01:23+00:00 | 0.000000073 | -0.000000322 | 0.000008846 | 9 M | -0.000000276 | 0.000000352 |
| 58638 | 00232 | | 2019-06-04T00:03:52+00:00 | 0.000000107 | 0.000000019 | 0.000008869 | 9 M | -0.000000486 | 0.000000387 |

JSON URL:

With the button "JSON URL" you will get the WEB address to receive the last measured value of the selected node. This can be used to read the current values via WEB access (wget or curl) from an external program. The JSON format is as follows:

```
{
  "SyncMon_Data": {
    "LastLogValues" : {
      "NodeName"      : "172.27.100.57",
      "OffsetLimit"   : 0.000000000,
      "RawOffset"     : -0.000050076,
      "MedianOffset"  : -0.000048733,
      "PathDelay"     : -0.000002693,
      "Status"        : 1,
      "LastErrorCode" : 0,
      "LastConfigChange" : 0,
      "LogTime"       : 1559025024
    }
  }
}
```

Edit Button:

With the "Edit" button all graphical parameters can be displayed and configured. The "Graph Correction Value" can be used to adjust the graph with a fixed offset (e.g. to compensate for a known asymmetry in a network or the runtime of a cable length). In contrast to the "Fix Offset", the "Graph-Correction Value" is only applied to the current graph and not to the stored data.

Graph Parameter for HPS_M3000_57_IO6

| | | |
|---|---|---------------------------------|
| Graph-Correction Offset for Measured Offset [s] | Graph-Correction Offset for Reported Offset [s] | Hide MinMax/MTie in Graph |
| <input type="text" value="0.000000000"/> | <input type="text" value="0.000000000"/> | <input type="text" value="No"/> |
| Hide in Syncmap | | |
| <input type="text" value="No"/> | | |

Export Button:

With the "Export" button a PNG file of the current graph will be generated. This can be used for printing and saving.

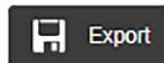

Generate Report Button:

With this selection the current data of the monitored node will be prepared in a form of a report. You can also select a time frame for sampled data from which a report will be generated. The report includes the current status data, monitor configuration, monitoring statistical values over the selected time frame, a graphical diagram and optional a full sync map related to the monitored node.

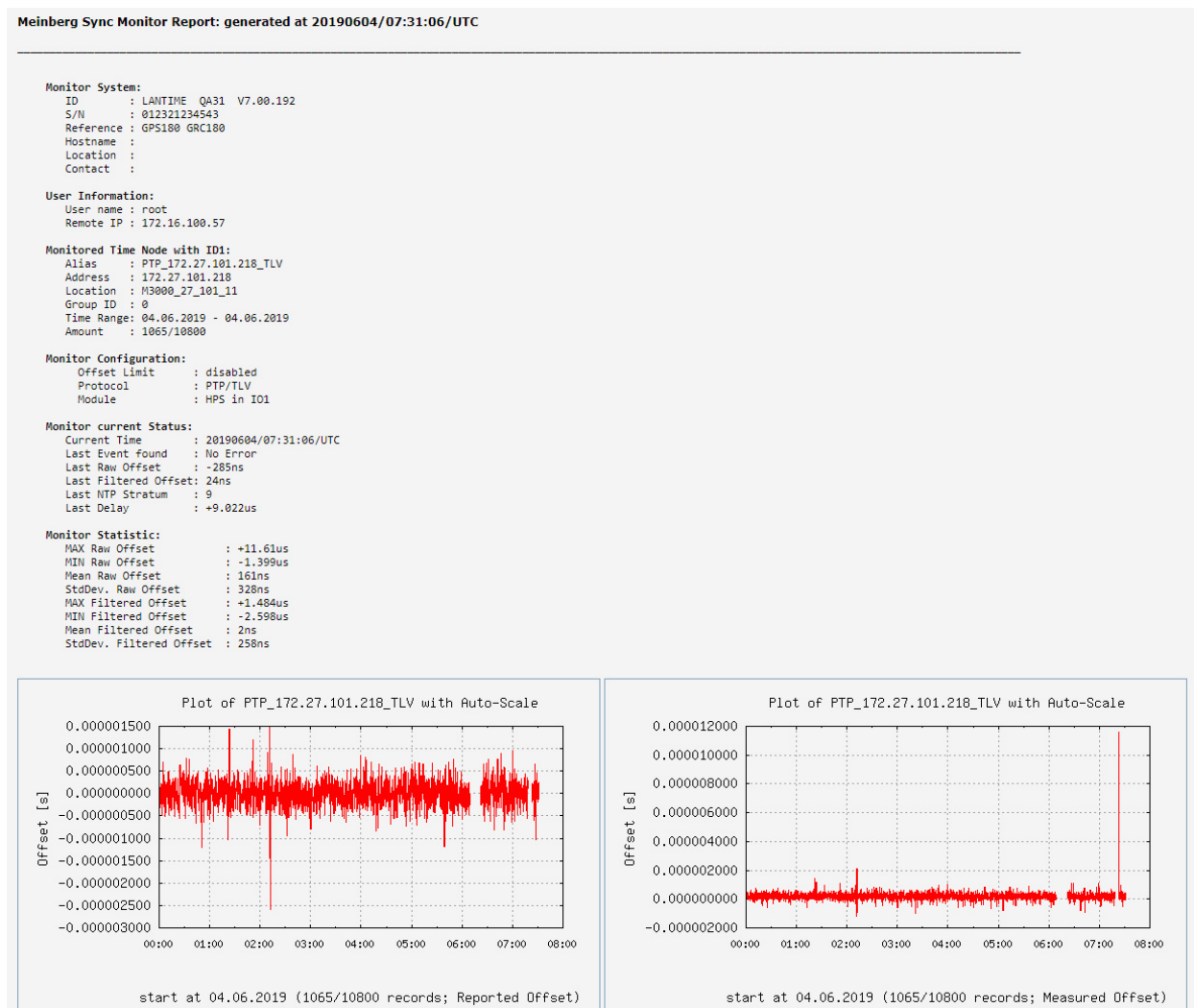

Figure: Generated report for a selected node. The report includes a status information of the selected monitored nodes, monitor configuration, main monitor statistics and graphical diagrams.

"Back" button in Graph view:

When choosing the graphic page the 'Back' button will go back to the main table view and showing the table with all configured nodes. In case of sensors the table of sensors will be opened automatically.

Error Logs:

Back in the main Sync Mon menu, by selecting the Error Logs button you will enter the Error Logs page of the selected monitored node. At this page the log messages are shown since the last system reboot. When the flash memory card gets full, the older logs will be overwritten.

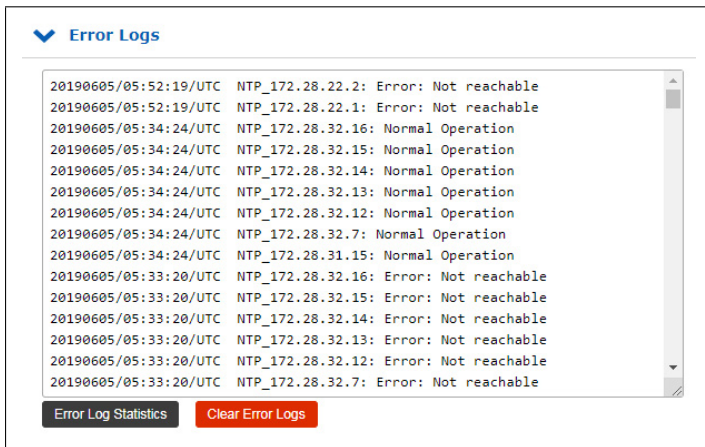
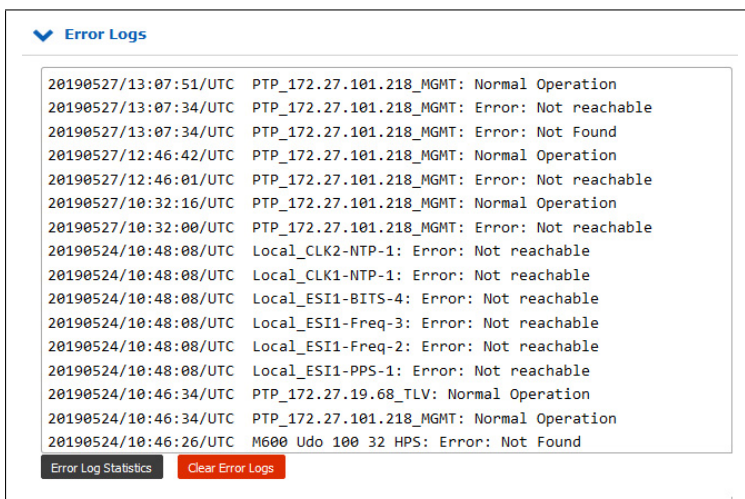
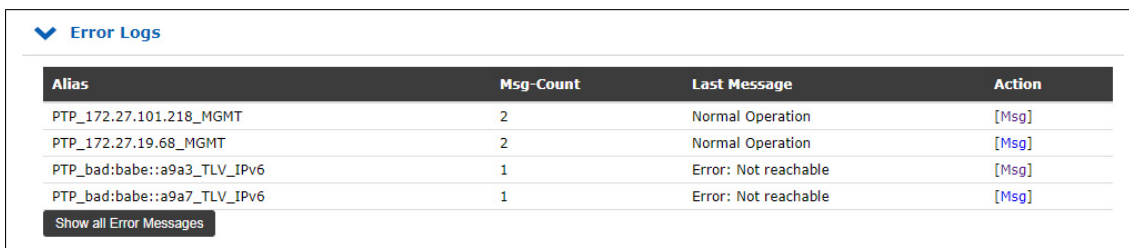

Figure: Error Log Messages for a selected monitored node.













At the bottom of the page there is a button "Show Global Error Logs" by which you can switch to view all Error Messages coming from all monitored nodes.



With "Clear Error Logs" all log entries will be removed. With "Error Log Statistics" an overview of logs of all nodes will be displayed.



9.1.12.12 Events

| Status | Action | Events |
|----------------|---|--|
| Slave / Dom:19 |    | |
| Slave / Dom:19 |    |  13 |
| Stratum:1 |    | |
| Master / Dom:0 |    | |

In the general overview table the last column Events is dedicated to different alarms, which are defined for monitored nodes:

- Offset limit exceeded
- not reachable
- Stratum limit exceeded
- monitoring not active



In case of "Offset Limit exceeded" and "not reachable" an icon with the count of events will be shown in the table of monitored nodes in the Events column. These events will be updated automatically every 10s. With the "**Reset Events**" button which can be found above the overview table you can reset the current counter for the events. These events are shown also in the SyncMap.

9.1.12.13 Actions for selected Nodes

In the firmware version 7.00 and following you are able to apply given actions at the same time to a number of selected nodes from the table. First select the nodes which you wish to manage, either by clicking individually a check box at the beginning of each node or by clicking on a "+" sign in the top row of the table if you wish to select all nodes together.

To deselect a node which has been selected, either click again into its check box and it will be deselected or click the "-" icon in the top row and you will deselect all nodes at the same time.

If you click the button "Actions for selected nodes" you will find actions which you can apply over the nodes.

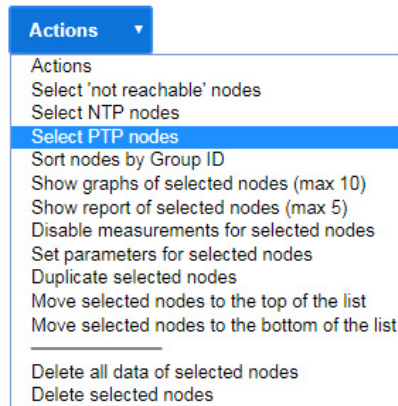

Select all "not reachable" nodes:

Selection of all nodes, whose offset status shows "not reachable".

Select all NTP nodes:

Selection of all nodes, which are monitored via NTP.

Select all PTP nodes:

Selection of all nodes, which are monitored via PTP, either MGMT or with TLV messages.

Sort nodes by Group ID:

The full list of nodes will be sorted by Group ID

Show overview of the current day:

If none of nodes has been primarily selected than graphical diagrams of the current day will be shown in a thumbnail form for all nodes in the table. Along with the graphical diagrams also the status information and statistics over the current day measurements will be displayed.

Show overview of the time range:

If none of nodes has been primarily selected than graphical diagrams of the selected time range will be shown in a thumbnail form for all nodes in the table. Along with the graphical diagrams also the status information and statistics over the selected time range measurements will be displayed.

Show a Graphical Diagram for selected nodes (max 10):

If you select up to ten nodes in the table, they can be displayed in the same graphical diagram. First, you have to select a time frame in which the graphical diagram will be displayed.

Create a Report for selected nodes (max 5):

If you select up to five nodes in the table, the current data of the selected nodes will be prepared in a form of a report. First, you have to select a time frame for which the report will be generated. The report includes the current status data, monitor configuration, monitoring statistical values over the selected time frame and a graphical diagram which shows the offset trend.

Besides, the report also provides a light version of a sync map, which includes only the selected nodes from the table. In the sync map each individual node is highlighted and the rest are depicted in the background to get a comparison of how the given node is performing in relation to other nodes considered in the report.

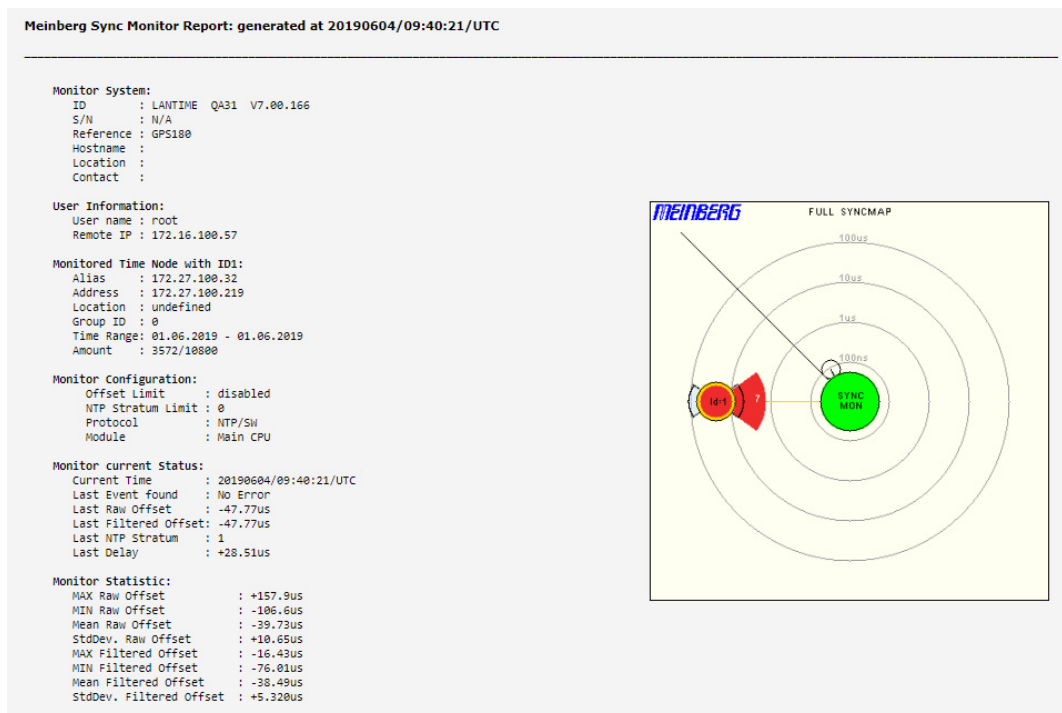

Figure: Generated report for selected nodes in the table. The report includes a status information of the selected monitored nodes, monitor configuration, main monitor statistics and graphical diagrams.

Disable measurements for selected nodes:

The nodes for which you disable measurements will get a status "Disabled". The measurements will no longer be requested and logged for this node. The latest measured offset will be shown in the Offset column. To start measurements again, select a node and choose "Enable measurements for selected nodes".

Set parameter for selected nodes:

For the selected nodes you can set or edit a list of monitoring parameters at the same time. When you select this feature the configuration dialog will show up where you can re-configure any of the parameters. The new configuration will be applied to all the nodes you have selected for this action after you confirm with the "Apply to Nodes" button.

Duplicate selected nodes:

The nodes which you have selected will be copied and pasted below their origin nodes. Afterwards you can edit their parameters.

Move selected nodes to the top of the list:

The selected nodes will be moved to the top of the list.

Move selected nodes to the bottom of the list:

The selected nodes will be moved to the bottom of the list.

Delete all data of selected nodes:

The logged measurement data of the selected nodes will be permanently deleted from the internal flash.

Delete selected nodes:

The selected nodes will be permanently deleted from the list of nodes. The logged measurements up to this point will be preserved.

9.1.12.14 Meinberg Sync Map

The Meinberg SyncMap is a graphical representation of monitored nodes in a network visualized as a polar diagram. The idea of the SyncMap is to give a quick overview of the synchronization status of all monitored devices in a complex network structure.

The monitored devices are called nodes. Nodes have to support one of the following signals: NTP (RFC1305), PTP (IEEE 1588v2) or PPS connected to ESI (Extension Signal Input) IMS card.

The goal is to visualize an absolute offset of monitored nodes in terms of predefined offset limits. The data can be shown according to the current offset status or over a selectable time range (e.g. one day). It is also possible to animate the dynamic behavior of the monitored nodes of the last 60min, where SyncMaps are generated automatically every minute. This mode is called SyncMap Cyclic Mode.

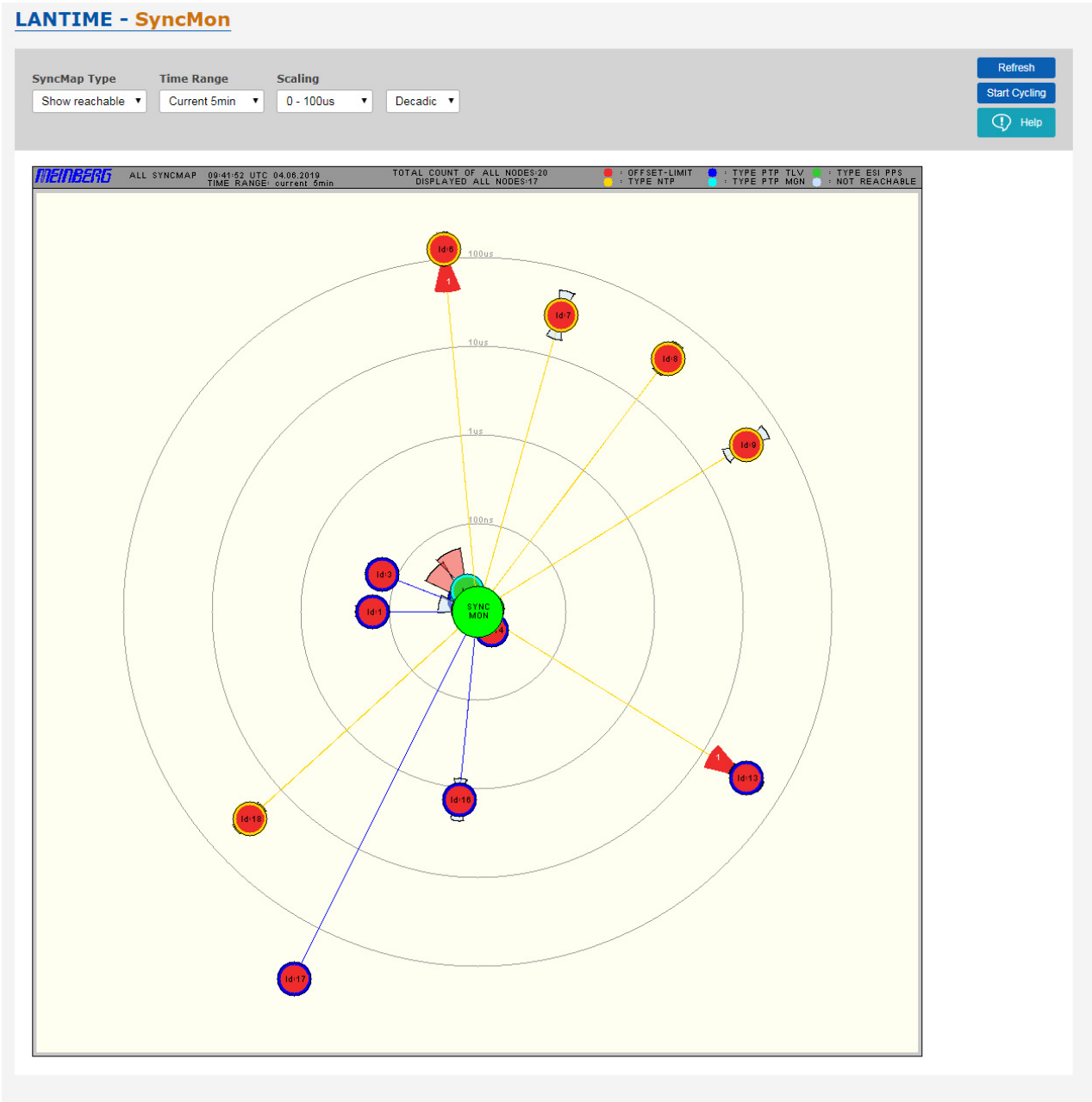

Figure: The SyncMap as a graphical representation of the monitored nodes in a network visualized as a polar diagram. It can display nodes which support: NTP, PTP (IEEE 1588v2) or PPS signals.

Each monitored node will be represented as a circle with different statistical information.

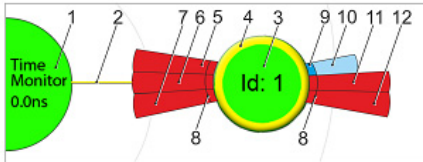

Figure: A node representation in the SyncMap. The meaning of different color codes and parts which belong to a node are explained in the text.

The Time Monitor reference with its reference clock stands in the middle, labeled as the "Time Monitor" [1]. It provides a timing reference by a controlled oscillator (synchronized by GPS, GLN, PZF, Galileo, Beidou or an external clock supply). The Time Monitor node in the center [1] is shown in green color when the reference clock is synchronous. In addition the current offset between the controlled oscillator and the reference time source is shown as a value [1].

Around the center four concentric circles representing the scaling of the polar diagram are drawn. All nodes [3] are connected concentrically by a line [2] from the central node. The distance from the center to the nodes represents the absolute average time offset between the Time Monitor and each individual node. The average value is calculated over the selected "Time Range". Each node is shown as a circle with a color inside [3] that corresponds the status and an outer ring [4], that corresponds its type.

- Status:
- green = Offset < Limit
 - red = Offset ≥ Limit or outside the maximum scaling
- Type:
- yellow = NTP
 - dark blue = PTP with TLV
 - light blue = PTP with Management Msgs
 - green = ESI PPS
 - grey = not available

Additionally, the statistical values: the standard deviation [8] is represented as circle segments. These values represent the temporal jitter of the measured values around the mean value. When the circle segment color is red, then the deviation is dependent on the scaling and it exceeds the half of range of the decade → example: if the middle deviation is in the range $1\mu s - 10\mu s$ and the largest found maximum $>5\mu s$, then the individual segment is drawn red, otherwise blue [10].

If one of the events occur "Offset Limit Exceeded" or "not reachable" then the circle segment will become dark red and a white value which represents the count of each event. The circle slide near the center [5,7] represent the Events "not reachable" and the outer circle slide [6,7] represent the Events "Offset Limit Exceeded".

While sliding with the mouse over a node in the SyncMap without clicking a corresponding info window with the name and some statistical values will be shown:

```

ID 1 - PTP_172.27.101.218_TLV
Address:          172.27.101.218
GroupID/Location: 0, M3000_27_101_11
Offset/StdDev:    590ns / 392ns
Offset Limit Exceeded=0 NotReachable=0
    
```

By selecting a specific node in the SyncMap with a left mouse click the following menu will be opened:



"Show Graphic" will open the corresponding graphical diagram.

Example of a full SyncMap

The following picture shows a SyncMap of a network with 250 monitored NTP nodes running on a Sync Fire. This is a real measurement of our Test-Network for burn in tests in the Lantime production. The red signed nodes are DCF77 receivers with no compensation of the distance between a transmitter site and a receiver.

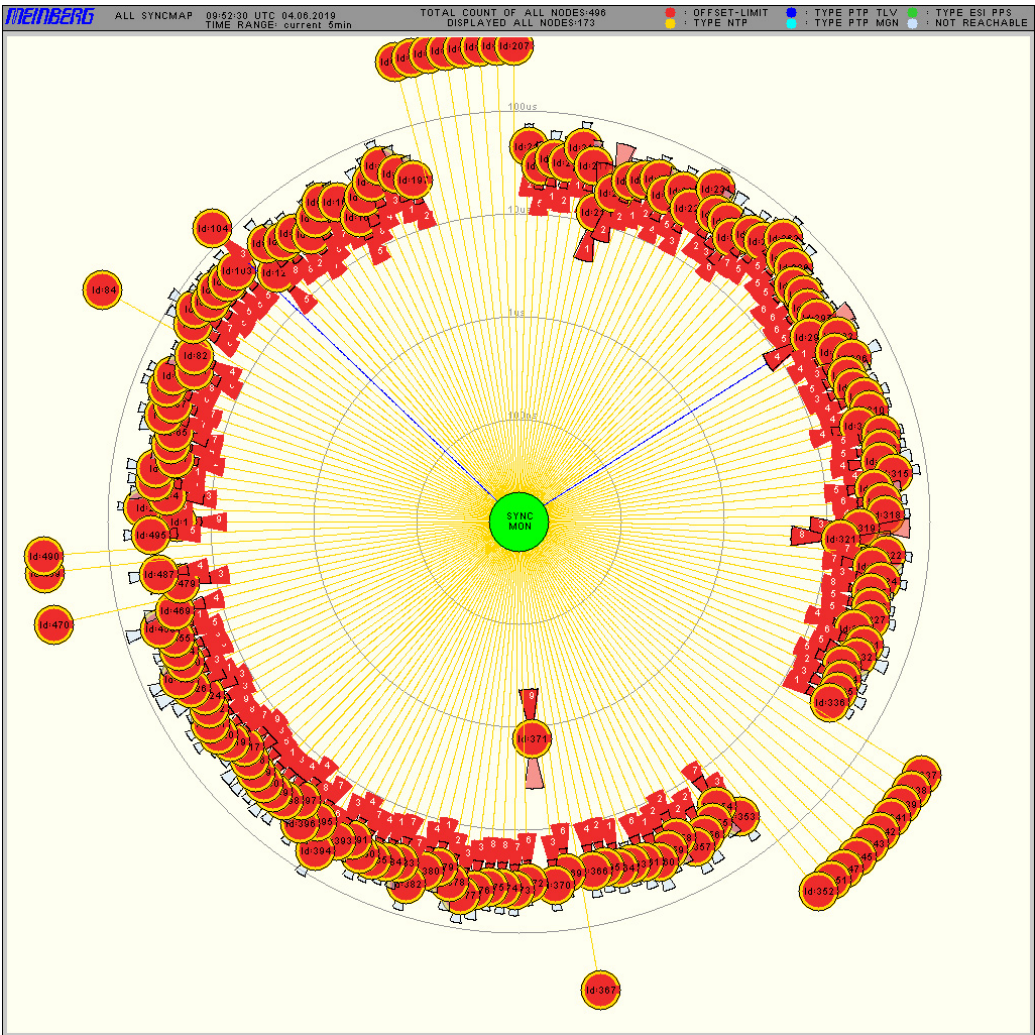

Figure: An example of a Sync map with 250 nodes.

Sync Map Type:

- Show reachable: currently reachable nodes are shown in the Sync Map.
- Show all Nodes: all nodes configured in the monitoring list are shown in the Sync Map, even unreachable ones.
- Show NTP only: only nodes which are monitored via NTP protocol are shown in the Sync Map. They will appear encircled with a yellow ring.
- Show PTP only: only nodes which are monitored via PTP protocol will be shown in the Sync Map. Nodes will appear with a dark blue ring if the PTP with TLV protocol is used for monitoring or with a light blue ring if the PTP protocol with Management Messages is used.

Time Range: the Sync Map can be generated using the monitoring data sampled in the past 30 min, past 5 min, in the past 24 hrs or within a manually selected time range. Also the statistical values are calculated using the data in the selected time interval respectively.

Scaling: possible scaling options: decade steps or linear for different time accuracy ranges. For PTP nodes it may be suitable to use scaling in lower microsecond range, whereas for NTP you can select ranges in a few 100microseconds or millisecond range.

Refresh Button: Immediately refreshes the Sync Map based on the currently available statistics of each single node. A new SyncMap with the selected time range will be generated- it is like a reload of this WEB page with the latest measurements.

Start Cyclic: will activate the SyncMap animation mode. In this mode every minute a new SyncMap with the latest measurements will be generated. The last 60 SyncMaps will be then displayed as an animation. A new sequence will start with a blank SyncMap. The statistics time range will be set by default to 5min.

The number of PNGs stored in RAM is set to 1000 in auto refresh mode if a Q7 CPU or a Syncfire is in use.

Help Button: will show the online help page for a SyncMap feature.

9.1.12.15 Sync Map - Help Window

Meinberg SyncMap Help Page

The SyncMap is a graphical representation of Time-Synchronization in a network visualized as a polar diagram.

A short legend:

- [1] The Time Monitor node and the current offset measured between its oscillator and the reference time.
- [2] Line connecting each node with the SyncMon. Its length represents the absolute average time offset between Reference of SyncMon and the node.
- [3] The color defines the sign of the average: yellow=negative blue=positive
- [4] A measured node, its color inside corresponds to its status.
- [5] Outer ring which corresponds the type of the node.
- [6] Event counter for "Node not reachable".
- [7] Event counter for "Node Offset Limit exceeded".
- [8] If Event counter > 0 then this slide is dark red. If Event counter = 0 the Standard Deviation is light red or light blue.
- [9] Standard deviation measurement. If light red, it exceeds the 100 percent of current offset, otherwise is blue.

The Network Sync Manager with its reference clock stands in the middle, labeled as the "SyncMon" [1]. It provides a timing reference with its controlled oscillator (synchronized by GPS, GLN, PZF, Galileo, Beidou or an external clock supply). The Time Monitor node in the center [1] is shown in green color when the reference clock is synchronous.

Around the center 4 concentric circles representing the scaling of the polar diagram are drawn. All nodes [3] are connected concentrically by a line [2] from the central node. The distance from the center to the nodes represents the absolute average time offset between the Time Monitor and each individual node. The average value is calculated over the selected "Time Range". Each node is shown as a circle with a color inside [3] that corresponds the status and an outer ring [4], that corresponds the type.

```

Status: green = Offset < Limit
       red   = Offset >= Limit or outside the maximum scaling
Type:   yellow    = NTP
       dark blue  = PTP with TLV
       light blue = PTP with Management Msgs
       green      = ESI PPS
       grey       = not available
  
```

Additionally, the statistical values: the standard deviation [8] respectively is represented as circle segments. This value represent the temporal jitter of the measured values around the mean value. When the circle segment color is red, then the deviation is dependent on the absolute average time offset and it exceeds the double (100%) of the absolute average time offset -> example: if average time offset is 5us and the standard deviation 10us (2001750f the average time offset), then the individual segment is drawn red, otherwise blue [10].

If one of the events occur "Offset Limit Exceeded" or "not reachable" then the circle segment will become dark red and a white value which represents the count of each event. The circle slide near the center [5,7] represent the Event "not reachable" and the outer circle slide [6,7] represent the Event "Offset Limit Exceeded".

[Close Window](#)

A short legend:

- 1 The Time Monitor node and the current offset measured between its oscillator and the reference time.
- 2 Line connecting each node with the SyncMon. Its length represents the absolute average time offset between Reference of SyncMon and the node.
The color defines the sign of the average: yellow=negative blue=positive
- 3 A measured node, its color inside corresponds to its status.
- 4 Outer ring which corresponds the type of the node.
- 5 Event counter for "Node not reachable".
- 6 Event counter for "Node Offset Limit exceeded".
- 7 If Event counter > 0 then this slide is dark red. If Event counter = 0 the Standard Deviation is light red or light blue.
- 8 Standard deviation measurement. If light red, it exceeds the 100 percent of current offset, otherwise is blue.

9.1.12.16 System Monitoring

System Monitoring monitors internal signals in the LANTIME system that do not belong to the monitored nodes (e.g. CPU utilization, local NTP, ESI inputs, MRS references and reference clock parameters). The number and type of internal signals depends on the integrated hardware components in a LANTIME system.

The System Monitoring is an optional function and disabled by default. It can be activated in the "Sync-Mon → System Settings" menu in the System Parameters dialog or directly via the "System Monitoring" tab:

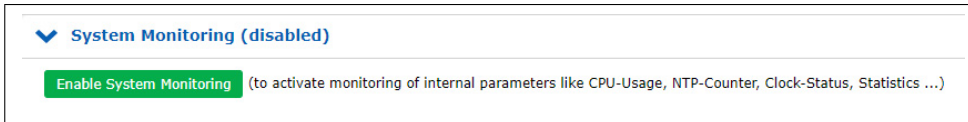





















If the System Monitoring is enabled, then all signals will be measured and logged automatically in the same way like Node Monitoring, namely System Monitoring page will be visible.

The number of MRS references (CLK1-GPS-0, CLK1-NTP-1, CLK1-PTP-2 ...) depends on the activated source priorities for each reference clock - this can be configured via "MRS Settings" in the web interface menu "Clock" for each reference clock used.

























Each node from the "System Monitoring" can be selected and displayed in a graph together with nodes from the "Node Monitoring".

List of possible Sensors in SyncMon:

| System Monitoring | | | | |
|-----------------------------|-----------------------|---------------------|---|--------|
| Sel. | Internal Parameters | Offset/State | Action | Events |
| <input type="checkbox"/> 25 | Local_NTP_Offset | -984ns [MinMax] |    | |
| <input type="checkbox"/> 26 | Local_NTP_Frequency | -234.35ppm [MinMax] |    | |
| <input type="checkbox"/> 27 | Local_NTP_Counter | 12.00/s |    | |
| <input type="checkbox"/> 28 | Local_CPU-Utilization | 13.49% |    | |
| <input type="checkbox"/> 29 | Local_CPU-Temperature | 57.00°C |    | |
| <input type="checkbox"/> 30 | Local_Available_RAM | 1800.28MB |    | |
| <input type="checkbox"/> 31 | Local_Free_Storage | 3096.04MB |    | |

Internal parameters:

NTP offset
 NTP frequency
 NTP Counter
 Local_CPU-Utilization
 Local_CPU-Temperature
 System Free RAM Memory Status
 System Flash Storage Status





















| Sel. | ESI Input | Offset/State | Action | Events |
|-----------------------------|-------------------------|--------------|---|--------|
| <input type="checkbox"/> 32 | Local_ESI1-PPS-1 | -49ns |    | |
| <input type="checkbox"/> 33 | Local_ESI1-Freq-2 | no pulses |    | |
| <input type="checkbox"/> 34 | Local_ESI1-Freq-3 | no pulses |    | |
| <input type="checkbox"/> 35 | Local_ESI1-BITS-4 | no pulses |    | |
| Sel. | PIO Parameters | Offset/State | Action | Events |
| <input type="checkbox"/> 36 | Local_PIO-IO4-Port0-PPS | no pulses |    | |
| <input type="checkbox"/> 37 | Local_PIO-IO4-Port1-PPS | no pulses |    | |
| <input type="checkbox"/> 38 | Local_PIO-IO4-Port2-PPS | no pulses |    | |
| <input type="checkbox"/> 39 | Local_PIO-IO4-Port3-PPS | -55ns |    | |

ESI input:

ESI PPS in
 ESI Freq in
 ESI BITS in

PIO Parameters:

PIO PPS in

| Sel. | MRS Parameters | Offset/State | Action | Events |
|--------------------------|-------------------------|--------------|---|--------|
| <input type="checkbox"/> | 40 Local_CLK1-GPS-0 | 5ns |    | |
| <input type="checkbox"/> | 41 Local_CLK1-PTP-1 | -20ns |    | |
| <input type="checkbox"/> | 42 Local_CLK1-NTP-2 | -31.99us |    | |
| <input type="checkbox"/> | 43 Local_CLK2-GNSS-0 | -5ns |    | |
| <input type="checkbox"/> | 44 Local_CLK2-NTP-1 | -31.94us |    | |
| Sel. | RSC Parameters | Offset/State | Action | Events |
| <input type="checkbox"/> | 45 Local_Diff-CLK1-CLK2 | 51ns |    | |
| <input type="checkbox"/> | 46 RSC-Auto-Manual-Mode | auto |    | |

MRS reference inputs:

- Standard GPS
- 10 MHz input frequency
- 1 PPS input signal
- combined 10 MHz plus PPS
- IRIG input
- Network Time Protocol (NTP)
- Precision Time Protocol (PTP/IEEE1588)
- fixed frequency
- 1 PPS in addition to time string
- variable input signal via GPIO
- DCF77 PZF providing much more accuracy than a standard LWR long wave receiver. e.g. DCF77 AM, WWVB, MSF, JJY
- GNSS receiver

RSC parameters:

- Local_Diff-CLK1-CLK2
- RSC-Auto-Manual-Mode

For each refclock:

- Refclock-State
- MRS-SubState
- Refclock-Usage
- Refclock-DCF-Field
- Refclock-DCF-Correlation
- Refclock-Sat-in-view
- Refclock-good-Sat
- Position change

9.1.12.17 Local NTP Counter

The LANTIME automatically counts all incoming network packets on UDP port 123 of all available network interfaces. This statistic is displayed graphically in the table "System Monitoring" under **Local_NTP_Counter**. The red line shows a value of the received NTP packets within a selected time period.



9.1.12.18 Error Logs

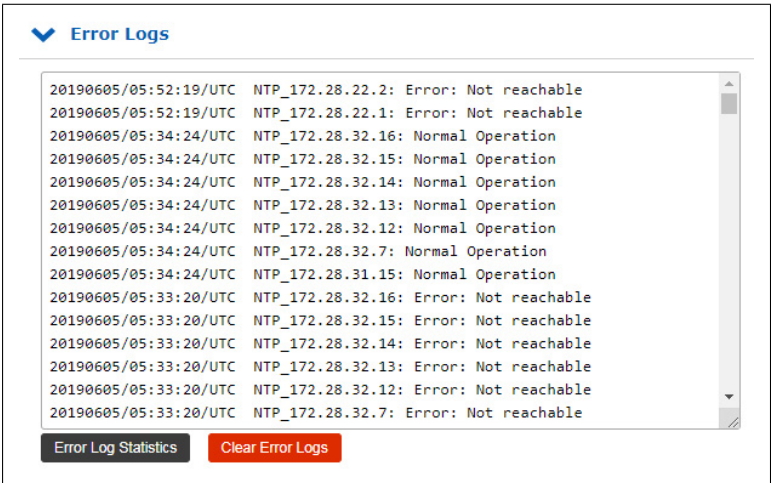

Figure: Log Messages from all monitored nodes.

Global Error Log gives the option to track all error events.

Error Log Statistics: categorization of error logs for each specific node.

Clear Error Logs: deletes the list of logged errors.

The screenshot shows a window titled "Error Logs" displaying a table of error log statistics. The table has four columns: "Alias", "Msg-Count", "Last Message", and "Action". Below the table is a button labeled "Show all Error Messages".

| Alias | Msg-Count | Last Message | Action |
|-----------------------------|-----------|----------------------|--------|
| PTP_172.27.101.218_MGMT | 2 | Normal Operation | [Msg] |
| PTP_172.27.19.68_MGMT | 2 | Normal Operation | [Msg] |
| PTP_bad:babe::a9a3_TLV_IPv6 | 1 | Error: Not reachable | [Msg] |
| PTP_bad:babe::a9a7_TLV_IPv6 | 1 | Error: Not reachable | [Msg] |

Figure: Error Log Statistics.

9.1.12.19 System Settings

The menu for "System Settings" will show the current available space on the flash disc and will calculate the count of days which can be stored depending on the count of monitored nodes and the log-interval.

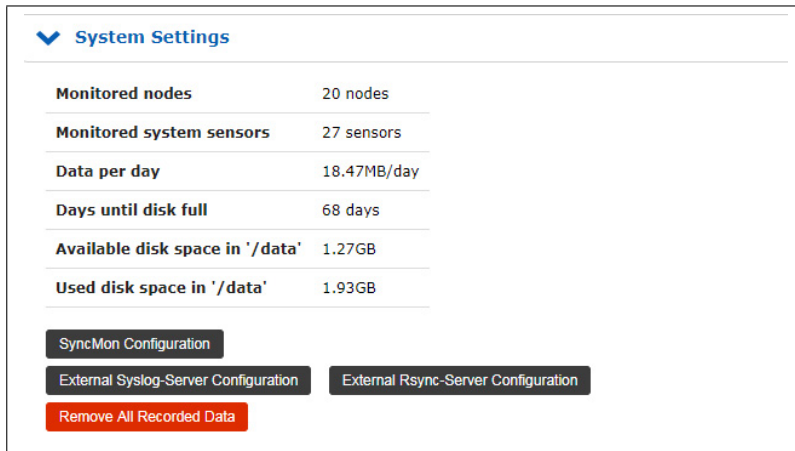

| System Settings | |
|---------------------------------|-------------|
| Monitored nodes | 20 nodes |
| Monitored system sensors | 27 sensors |
| Data per day | 18.47MB/day |
| Days until disk full | 68 days |
| Available disk space in '/data' | 1.27GB |
| Used disk space in '/data' | 1.93GB |

Buttons below the table:

- SyncMon Configuration
- External Syslog-Server Configuration
- External Rsync-Server Configuration
- Remove All Recorded Data

Figure: Memory card status, available space left and logfiles archiving options.

There is an indicator implemented which informs about the available flash space "Available Space on Flash" and the number of days left for monitoring of the current sync node setup. The current data will be stored on the flash card.

With the button "Remove All Recorded Data" all files on the flash storage belonging to SyncMon will be removed without a backup.

9.1.12.20 Send Monitoring Data to external SYSLOG Server as a Backup

In SyncMon Menu in the Web Interface menu "System Settings → External Syslog-Server Configuration" you can configure up to 3 external Servers, where the measured data is sent at each log interval via the SYSLOG protocol. On the external server has to run a service like a standard Syslog-Server.

In order to backup the monitoring data and store them for later analytical processing, you can enable automatic sending of the data via SYSLOG protocol to up to 3 external database servers. In this case every node measurement processed in a log-interval will be sent to a specified server.

In the following dialog you can configure the target servers where you want to store your data.

Figure: Configuration options for external database servers where the monitoring data can be stored.

For each of these external servers the following parameters can be set:

- network protocol: UDP or TCP
- a port number (default is 514 for standard SYSLOG)
- a device name
- optionally the IP Address of the network port used for the measurement can be activated
- configuration of the output format:
 - Meinberg Standard Format
 - Key-Value-Pairs (SPLUNK friendly)
 - JSON Format

As Network Protocol options you can choose between the UDP or TCP/IP protocols, running as per default on a port:514.

Name of this SyncMon device: you can monitor your network by different Sync Monitoring devices. You can give them unique names to recognize it easily in the database server, where the data come from.

The Meinberg Standard Format corresponds to the SyncMon data format stored in a file system on a LANTIME. This will be later used for the SyncMon Manager. The SyncMon Manager is currently in development and will be able to visualize the data stored on an external server and generate reports.

An excerpt of the SyncMon format "Meinberg Standard Format" sending via Syslog protocol:

```
SyncMon 172.27.100.32 M3000_100_57_NTP_LAN0 58154 34813 2018-02-05T09:40:13+00:00
0.000000494 0.000041453 0.000073266 1 R -0.000011100 0.000041453
```

For more Details about SyncMon formats see chapter "Appendix → SyncMon Formats".

9.1.12.21 Copy Monitoring Data to external Server via RSYNC as a Backup

In SyncMon Menu in the Web Interface menu "System Settings → External Rsync-Server Configuration" you can configure up to 3 external Servers, where the measured data is copied every hour or once at 00:00 UTC via the RSYNC protocol. On the external server has to run a service like a standard RSYNC-Server.

In the following dialog you can configure the target servers where you want to store your data.

RSYNC-Server

Figure: External RSYNC server configuration

To automatically send data hourly or once a day via 'rsync', you must prepare the ssh key for the external RSYNC server:

- Registration via SSH on LANTIME
- Check if identities are available in `/root/.ssh/id_rsa.pub`.
- If not, create an identity with `'ssh-keygen -t rsa'`.
- Save this identity for permanent use with: `'saveconfig @'`.
- Copy the identity of the LANTIME to the external RSYNC server with: `'ssh-copy-id ip-adresse-of-RSYNC-server'`.

9.1.12.22 SyncMon Configuration

With the "SyncMon Configuration" button some system configuration parameters can be set:

- Source Port of outgoing NTP packets: default is 33000.
- Base Path for logfiles for history of days. The default path is the internal compact flash with /data. e.g. this could be changed to /mnt/usb-storage if an USB-Memorystick is used.
- Enable Monitoring of System internal parameters.

Figure: System Parameters settings within the SyncMon feature. Here you can set the current path where the data is stored. Be aware when the flash card is full, the oldest data will be overwritten.

Enable System Monitoring: the monitoring of internal signals like CPU-Utilization, local NTP, ESI inputs, MRS-References and Refclock parameters, depending on integrated hardware of the system will be activated. By default the monitoring of the system is disabled.

The measured data of the monitored nodes will be stored in separate directories on a flash disc. The base path of the stored data files can be configured by the user, therefore it is also possible to use an external flash disc (e.g. USB stick). The data will be stored separately for each day and each monitored node.

```

/data
|
| /stats
|
| /syncmon
|
| /alias-name1
|
| /ntp_mon_stats.20190501
|
| /ntp_mon_stats.20190502
|
| /ntp_mon_stats.20190503
|
| ...
|
| /alias-name2
|
| /ntp_mon_stats.20190501
|
| /ntp_mon_stats.20190502
|
| /ntp_mon_stats.20190503
|
| ...

```

Figure: Example for default path structure of history of days data files on the flash card.

The data file format:

1. MJD: Modified Julian Date - is the continuous count of days since the beginning of the Julian Period (started at 1858 Nov 17 - 0:00)
2. time past midnight in seconds
3. time stamp (ISO from MJD and time past midnight)
4. measured clock offset raw (If the request interval is less than the Logging interval then the mean value of the measured offsets at request interval will be stored)
5. in case of NTP: clock offset median (Median of the 5 last measured offsets at request-int
in case of PTP: reported offset)
6. path delay in seconds
7. NTP stratum or PTP state
8. 'R' (optional indicator for min/max values of raw data: if the request interval is less than the log-interval then automatically the Min and Max values of the raw data will be stored in the next 2 lines
see 8. (optional)
9. see 8. (optional)
10. see 8. (optional)
11. 'M' (optional indicator for min/max values of MTie (Maximum Time interval error) values from PTP nodes which supports this option: if the PTP node support MTie feature with extended TLVs then the Min and Max values will be stored in the next 2 lines.
see 11. (optional)
12. see 11. (optional)
13. see 11. (optional)

Samples of Monitoring Data stored in the history of days files:**Example for NTP data files:**

```
# Day Sec Modified_Julian_day_time Raw_offset Median_offs Path_delay Stratum
58043 21705 2017-10-17T06:01:45+00:00 -0.000000129 -0.000000053 0.000007667 1
```

Example for NTP data files with request interval less than log interval:

```
# Day Sec Modified_Julian_day_time Raw_offset Median_offs Path_delay St Min Max
58043 21705 2017-10-17T06:01:45+00:00 -0.00000129 -0.000000053 0.000007667 1 R -0.01 0.01
```

Example for PTP data files:

```
# Day Sec Modified_Julian_day_time Raw_offset Report_offs Path_delay Portstate
58043 21705 2017-10-17T06:01:45+00:00 -0.000000129 -0.000000053 0.000007667 9
```

Example for PTP data files supporting Mtie feature:

```
# Day Sec Modified_Julian_day_time Raw_offset Median_offs Path_delay St Min Max
58043 21705 2017-10-17T06:01:45+00:00 -0.00000129 -0.000000053 0.000007667 9 M -0.01 0.01
```

9.1.12.23 System Utilization

With the latest SyncMon version it is possible to configure up to 1000 nodes to monitor. The request and logging interval can be set to 1s. Be aware that system CPU will be heavily used in case of high counts of nodes and low request and log-intervals. This could decrease the NTP server performance as well.

Examples:

- 10 monitoring nodes with log-interval = 1s will store 70MBytes (69194kBytes) per day – the default size of the flash used for SyncMon logging is about 400MB – so 5 days can be stored on internal flash disk.
- 100 monitoring nodes with log-interval = 1s will store 700MB per day – then data logging will stop if the flash is full – the log rotating for SyncMon will be started at 00:00 UTC and will erase data files older than 2 days. The CPU utilization will increase about 10%.
- 100 monitoring nodes with request interval = 1s and log-interval = 64s will store about 12MBytes per day – so about 40 days can be stored on internal flash disk. The CPU utilization will increase about 7%.
- 900 monitoring nodes with request interval = 1s and log-interval = 64s will store about 100MBytes per day – so about 4 days can be stored on internal flash disk. The CPU utilization will increase about 45% – this is critical for the NTP server performance of the device.

The size of a data file per day depends on the logging interval and has a size of about 110kB if log-interval is 64s.

9.1.12.24 Sync Monitor Status files via CLI

The current status of the monitored nodes as displayed in the Web-GUI is stored in an ASCII file `/var/log/syncmon_node_status`, updated after every full scan of the configured nodes and can be accessed over CLI.

```
# Net Sync Monitoring Status with total 15 Nodes (updated at ...)
# Node-Address      NTP:Offset      -filtered      Delay      NTP-Stratum    Auth  MTIE    CntErr    CntErr    Err    Message
# PTP:OffsNode     -measured
# -----
172.16.100.65:      -0.000113960    0.000055254    0.001663415  2          0  0      3         0         0      Normal Operation
172.16.3.11:        -0.005109100    -0.005896857    0.001891819  1          0  0      0         0         0      Normal Operation
172.16.3.12:        -0.028305041    -0.028305041    0.001669302  2          0  0      0         0         1      Error:Offset exceeded
172.27.101.90:      -0.000037604    -0.000002865    0.000352269  2          0  0      0         0         0      Normal Operation
172.27.100.32:      0.000008375     0.000008375     0.000209699  1          0  0      0         0         0      Normal Operation
172.27.100.1:       0.000000899     -0.000027105    0.000416735  1          2  0      0         0         7      Error:Auth. Failed
ESI-Module:        0.000001819     0.000001839     0.000000000  0          0  0      0         0         0      Normal Operation
EC:46:70:00:8F:64: 0.000000000     0.000000000     0.000000000  0          0  0      0         0         6      Error:Not active
172.27.19.68:       0.000000109     -0.000000013    0.000007451  9          0  0      0         0         0      Normal Operation
EC:46:70:00:8F:64: -0.000000049    -0.000000171    0.000006273  9          0  0      0         0         0      Normal Operation
172.27.19.70:       0.000000030     -0.000000035    0.000007749  9          0  0      0         0         0      Normal Operation
172.27.19.98:       0.000000000     0.000000000     0.000000000  0          0  0      0         0         3      Error:Not reachable
172.27.101.143:    0.000000000     0.000000000     0.000000000  0          0  0      0         0         3      Error:Not reachable
172.27.19.11:       -0.000010202    -0.000090331    0.000052625  8          0  1      0         0         0      Normal Operation
172.27.101.90:     0.000000000     0.000000000     0.000352269  2          0  0      0         0         3      Error:Not reachable
```

Figure: The status information table accessed over a CLI.

Configuration via CLI

The configuration file can be edited with a text editor directly in the command line (CLI) of the system or can be replaced by an external prepared file. Further information can be found in the LANTIME CLI reference ([Sync Monitor Configuration via CLI](#)).

9.1.12.25 Sync Monitor Configuration via CLI

The configuration of all monitored nodes will be stored in one central ASCII file `/etc/mbg/syncmon.cfg`. Each line will represent the configuration of one node to monitor.

```
# Time Monitoring Node
Configuration
#
@ SourcePort: 33000
@ BaseLogPath: /data
@ BaseCurrDayPath: /data
# Supported Time Protocols: 0:NTP 1:MBG-PTP
# Support ESI Module: Protocol value define the input port
#
# IP4-Address      CPU-Module  Interface  Protocol  Offset-Limit[s]  Stratum  Req-Intv  Log-Intv  Group  Alias  Location
NtpKey  NtpKey      NtpKey
# IPv6 or MAC    (MainCPU=-1)  Name      Index      Domain      Index
Index  Type      Secret
-----
addr=172.75.75.3      cpu=08  intf=all  prot=1  offs=0.000001000  domain=7  req=64  log=64  grp=0  alias=Master_TLV  loc=M3000_training_rack
addr=172.75.75.3      cpu=08  intf=all  prot=2  offs=0.000001000  domain=7  req=64  log=64  grp=0  alias=Master_MGMT  loc=M3000_training_rack
addr=172.75.75.1      cpu=08  intf=all  prot=1  offs=0.000001000  domain=7  req=64  log=64  grp=0  alias=Slave1_TLV  loc=M3000_training_rack
addr=172.75.75.1      cpu=08  intf=all  prot=2  offs=0.000001000  domain=7  req=64  log=64  grp=0  alias=Slave1_MGMT  loc=M3000_training_rack
addr=172.27.75.225    cpu=08  intf=all  prot=2  offs=0.000001000  domain=10  req=64  log=64  grp=0  alias=Boundary_Clock_1  loc=training_rack
addr=172.75.75.10     cpu=08  intf=all  prot=1  offs=0.000001000  domain=10  req=8  log=8  grp=0  alias=Slave2_TLV  loc=M500_training
addr=172.75.75.10     cpu=08  intf=all  prot=2  offs=0.000001000  domain=10  req=8  log=8  grp=0  alias=Slave2_MGMT  loc=M500_training
addr=172.27.100.194   cpu=-01  intf=lan0:0  prot=0  offs=0.001000000  strat=10  req=64  log=64  grp=0  alias=NTP_M500_unit  loc=M500_training
kidx=-1
addr=ESI-Module      cpu=10  prot=1  offs=0.000001000  req=8  log=8  grp=0  alias=PPS_Slave2  loc=training_rack
```

- addr : IP4/6 or MAC address of the node to monitor
- cpu : ID of the IMS card: main cpu=-1 HPS100=0 – 9 ESI IMS card=10-11
- prot : Synchronization Protocol for monitoring: NTP=0 PTP/TLV=1 PTP/Mngt=2
- offs : Offset Limit
- stra : NTP Stratum Limit
- domain : PTP domain
- req : Request Interval [s]
- log : Log-interval [s]
- grp : Group ID
- alias : Alias name defined by user
- loc : location string
- kidx : NTP Key ID ('-1' if not used)
- ktyp : NTP Key Typ (M=MD5 see NTP documentation)
- ksecre : NTP Key Secret (see NTP documentation)

This file can be edited with a text editor directly in the command line of the system or can be replaced by an external prepared file. The monitor program will check this configuration file for changes automatically after every full scan of the configured nodes.

9.1.13 Documentation and Support

This page provides easy access to some documents stored on your LANTIME, in particular the manuals. The list shows the filename, language, file type, date, and size of the documents/notes.

| Available Documents | | | | | | |
|---------------------------|----------|------|------------|------------|----------------------|--|
| Filename | Language | Type | Date | Size | Option | |
| ltos_7-04-cli | german | pdf | 2015-06-26 | 1767.93kb | View | |
| ltos_7-04 | german | pdf | 2015-06-26 | 22992.68kb | View | |
| cli_and_restapi_reference | english | html | 2021-11-02 | 0.40kb | View | |
| 3 Documents available | | | | | | |

LT_CLI Help

A link to the LT_CLI online help is also provided. This online help is available on all IMS LANTIME devices and on all SyncFire systems with system RAM of at least ≥ 512 MB, and can be opened via the link.

For users who do not have such a system, we have made this online help feature accessible from our public web server: http://demo.meinberg.de/lt_cli/.

This CLI help can also be downloaded as a ZIP archive:
http://demo.meinberg.de/lt_cli/firmware-7.04.008-x86-clihelp.zip.

Once downloaded, the file should be unzipped to your own file system, either in your network environment or on your local PC. Once this is done, the help can be accessed like a normal web page.

The Support Information chapter provides all necessary information on how to contact Meinberg Technical Support, and also includes a link to Meinberg's firmware update page.

| Support Information | | |
|---|------------------|---|
|  | Phone | +49(0)5281 9309888 |
|  | Email | techsupport@meinberg.de |
|  | Firmware Updates | https://www.meinbergglobal.com/english/sw/firmware.htm |
|  | RMA | https://www.meinbergglobal.com/english/support/rma.htm |

The "Docs & Support" tab also provides some important weblinks and contains information about the Meinberg Sync Academy - MSA.

Meinberg Sync Academy

Description If you wish to learn more about:

- **Time & Frequency Synchronization,**
- **LANTIME features, Web GUI configuration and management,**
- **NTP / PTP fundamentals,**
- **Meinberg Product's hardware and software for successful troubleshooting,**

then join us at one of the upcoming trainings at **Meinberg Sync Academy!**

MSA offers trainings and workshops in the field of time- and frequency synchronization, held by highly experienced instructors. The tutorials consist of theoretical lectures and „hands-on labs“ for a better understanding and realistic experience.

Internet <https://www.meinbergglobal.com/english/support/meinberg-sync-academy.htm/>

Email academy@meinberg.de

Impressions



The Meinberg Sync Academy develops and offers training courses in the field of time and frequency synchronization, covering topics such as NTP, IEEE 1588 PTP, and many more. This part of the LANTIME "Docs & Support" tab provides some basic information about the Sync Academy, along with some links to helpful information at: <https://www.meinbergglobal.com/english/support/meinberg-sync-academy.htm>

9.2 Via Front Panel Display

9.2.1 LANTIME Display Types

For our LANTIME NTP server, there are four different display types – this is due to the design, housing and by the functionality of the systems. In principle the functionality and menu navigation in all four display types the same. The difference arises from the used receiver system and the available device options.

The high-resolution VF-Display, which is used in our LANTIME M600 systems, also offers a graphical representation of the measured input signals (NTP, PTP, IRIG, PPS ...). The graphic VF-Display is described in the following chapter.

The illustrations of the configuration menus is reacted with a four-line graphics, the menus of the respective systems may differ in the display of it (see Figure 1.0).

```
GPS: NORMAL OPERATION   Mon , dd.mm.yyyy
NTP: Offset PPS:  -4µs   UTC 12:00:00
```

M200 / M300

```
GPS: NORMAL OPERATION
NTP: Offs. PPS: 0µs
Mon. 26.04.2010
UTC: 11:06:32
```

M400 / M900 / IMS-Series

```
07:23:25 UTC
Thu, 30.12.2010
NTP: Offs. PPS: 5µs      Stratum: 1
GPS: NORMAL OPERATION   Satellites: 8/8
PTP2: ok INITIALIZING   GM: 00.....
Press F1 for help or F2 for setup overview
```

M600

```
NORMAL OPERATION
NTP: Offs: -5µs
THU, 26.06.2010
UTC 12:12:00
```

SyncFire

Figure 1.0 - LANTIME Displays

| | |
|---------------|---|
| SyncFire | LC-Display, 4 x 20 characters |
| M200/M300 | LC-Display, 2 x 40 characters |
| M400/M900/IMS | LC-Display, 4 x 16 characters |
| M600 | Vacuum Fluorescent Graphic Display (VFD), 256 x 64 Dots |

9.2.1.1 Description of the graphical menu: VF-Display

The graphical menu is used to graphically display offset values ¹ between a given input signal ² and the oscillator of a GPS card. The program can be started with the ↑ button in the corresponding status menu. Furthermore, a list of various offsets for the input signals respectively is available in the MRS status function. To access it please press the ↓ button if you are in the main menu (where the current time is displayed).

The main menu of the Lantime (where time and date in the selected time zone are displayed).

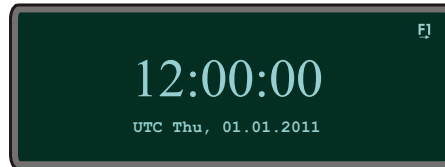

Choose Reference Time ↓, MRS Management, MRS Status and Setup, and eventually MRS Status. Now you can choose whether the numerical offsets of all available input signals should be displayed or if a graphical display program should start. If the graphical option is selected you have to choose one of the input signals as a reference.

By pressing buttons ↑ and ↓ one can change among several reference signals and select one by pressing the OK button. In the graphic mode one can choose among four different display options how the offset of a given reference signal shall be displayed (online mode, full graph, statistics and scrolling mode).

The cursor position and consequently the option selection can be modified with the ↑ and ↓ buttons. In the upper right corner one can find the selected reference source signal, which offset is graphically displayed. With the OK or → button the selected graphical mode can be started.

Main menu of the graphical display with various options:

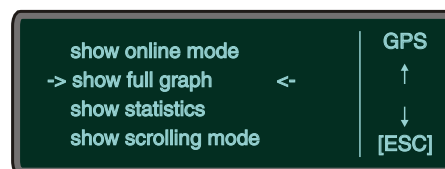

Each of these modes contains an information menu accessed by F1. One can find here some current status information as well as selection buttons and options of the current mode. With the ESC button one can always return to the menu on the upper level.

¹Offset: an offset is a time difference between two systems. In our example, the offset is time difference between a given input signal and an oscillator, which disciplines its local clock.

²Input signals: GPS, PTP, PPS, NTP, TCR, FRQ- which of these input signals are available can be identified from the numerical status (Numerical Status)

Each graphic mode is displayed within a range of values: ³

Display of the selected mode (here: SCROLLING MODE)



After one of the graphical menu options is selected, the current mode appears for one second on the display. Under the current mode the origin file from which the graphic is generated appears in small fonts.

The first mode is the “ONLINE MODE”

This mode displays the last 255 offset values and it checks regularly for new offsets. When a new value appears the graphic display shifts six pixels to the left to make space for the new values. Additionally, the time range is displayed below and the offset range on the left.

Graph of the Online Mode (not zoomed)

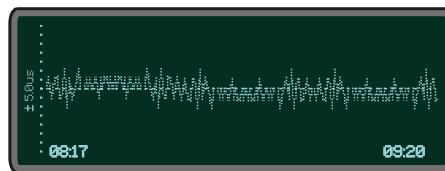

With the ↑ (zoom in) and ↓ (zoom out) buttons the range of the y-axis can be changed any time in order to display graph larger or smaller.

Graph of Online Mode (zoomed out)

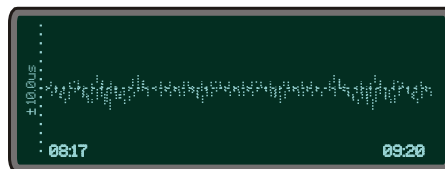

The next mode is the “FULL GRAPHIC MODE”

After the status mode is displayed, offset values start being plotted. All values from the statistic file are displayed as long as no more than 255 values are available. If more values than a display length (255 points) are available, only each xth offset value ⁴ is displayed.

Thus a mean value graph is generated which looks similar to this one: An example of a generated graph with the corresponding range of values (here: FULL GRAPHIC)

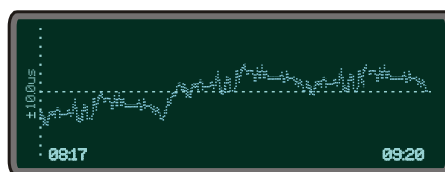

³The display has an x and y axis: the y-axis displays the offset value, which is the higher between absolute minimum and maximum value and is computed automatically at the first start of the menu. It is step-wisely ordered as follows: +- 1, 2, 5, 10, 20, ... (in 30 day [d] units – one picosecond [ps]). The x-axis is a time axis. It shows from and until when particular offset values occur.

⁴The xth value is the number of available values divided with the display length.

The range of values is automatically adjusted. The x-axis starts with the first chronological value available in the given file. The last value is not necessarily also the last value from the given file. If more than 255 values are available then only each xth value is displayed.

A legend can be displayed by pressing the F2 button. It contains the value range, as well as the minimum and maximum of the graphic. By pressing a F2 button for the second time the legend disappears.

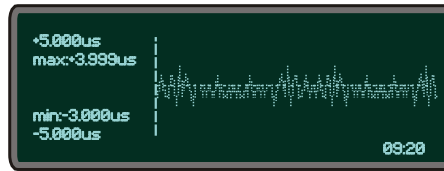

The help menu appears by pressing the F1- information button in the "FULL GRAPHIC MODE". It shows all available options in this mode. Other options are only partially available from here. To end this function one has to press ESC-, OK- or again the F2- button.

In the "FULL GRAPHIC MODE" the graph can be maximized or minimized with ↑ (zoom in) and ↓ (zoom out) buttons. If the legend is currently displayed, selecting the zoom-buttons causes that the range of y-axis gets automatically adjusted and the legend renewed. With the ESC-button one can get back to the main menu of the graphical program where the legend is not displayed. Alternatively, a display returns back to a "FULL GRAPHIC MODE" with a default value range.

The „Statistic“ - option comes next in the graphic menu. When you select it, you can decide if the minimum or the maximum value of the current statistics file shall be displayed or not.

The minimum or the maximum values are plotted in the middle of a display, as long as at least 128 values (a half of the display length) are available. A legend is shown on the display at the same time and apart of the minimum or maximum value also the corresponding UTC time is displayed ⁵.

Display of the minimum including the legend:

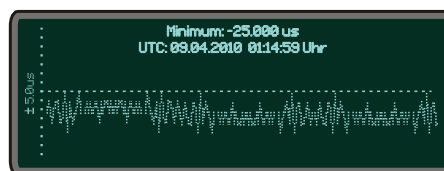

Display of the maximum including the legend:



The "SCROLLING MODE" comes as last in the graphical mode

After the status mode is displayed the whole available offsets are shown in a scrolling way. The ↑ or ↓ buttons refer in the „SCROLLING MODE“ to its scaled up or scaled down range of values of the y-axis. Each time when selecting these two buttons the „SCROLLING MODE“ starts again from the beginning. Pressing the OK or ← button causes that the graphic holds on; and pressing the OK or → again the graph continues to scroll on. When the mode is stopped (the value range will be displayed) one can change the y-axis value range with the ↑ (scaled up) and ↓ (scaled down) buttons. The offset values will only be scrolled to the end of a display

⁵UTC: Universal Time Coordinated is the standardized world time which does not include daylight saving time change

and again with the OK or → button the scrolling will continue.

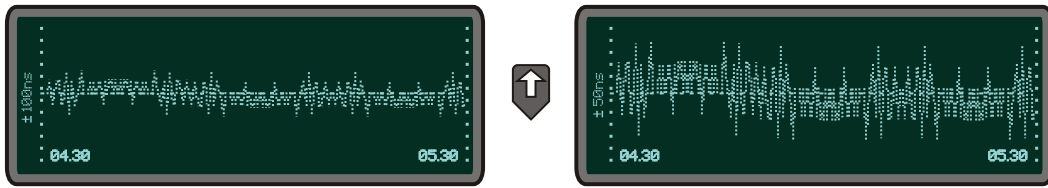

When the ← button is selected the displayed graph moves half of a display to the left if the „SCROLLING MODE“ has not been stopped beforehand. Even here the value range of the y-axis can be changed or the graph can be shifted a few more steps to the left. In order to continue the scrolling mode one has to press the OK or → button. If you select the ESC button then you come back to the main menu of the graphical program.

9.2.2 Front Display - Root Menu

The root menu is shown when the receiver has completed initialization after power-up. With the four arrow buttons and the buttons „OK“, „ESC“, „F1“ and „F2“ the navigation and setting of parameters can be managed. Main menu can be reached by holding „ESC“ for a few seconds. The main menu reflect some of the main parameters of the time server. First line shows the name of the device and the status of the reference clock. The text "NORMAL MODE" might be replaced by "NOT SYNC". If a existing antenna connection is interrupted or not working properly, the text "ANTENNA FAULTY" is displayed instead.

With an integrated time code receiver it might be possible, that the message "NO DATA" appears on the display - in this case the correct value can be set in the time-code parameter submenu.

Current time and date of the timeserver with the name of the time zone (NTP uses UTC time zone) will be monitored in the bottom line. If the "SIMULATION MODE" option is enabled an "*" will be shown behind the time.

The multicolor LEDs will reflect the current state of the device:

„Ref. Time“

green: the reference clock produce valid time.

red: the reference clock produce no valid time (e.g. not synchronized)

„Time Service“

green: NTP has been synchronized to reference clock.

red: NTP is not synchronous to reference clock or sync to „local clock“

„Network“

green: all watched network ports has been "link up" detected

red: at least one of the watched network ports (look at „Setup Device Parameter / Check Network Linkup“) is not connected

„Alarm“

off: no error at moment

red: general error – more information will be shown on display.

If the symbol „F1“ will be shown in the upper right corner a help page can be displayed when pressing the „F1“ button. When pressing „F1“ from main menu a short description for menu navigation will be displayed:

Use → and ← to
select different
main menus. Use
↑ and ↓ to enter.

When pressing the „OK“ button from main menu the version of the LANTIME software, the NTP and the LINUX kernel version will be displayed.

ELX800 VX.XXx
SN: 000000000000
NTP: X.X.Xx@X.X
Krn.: X.X.XX.X

The following main menus will be displayed when pressing the arrow buttons:

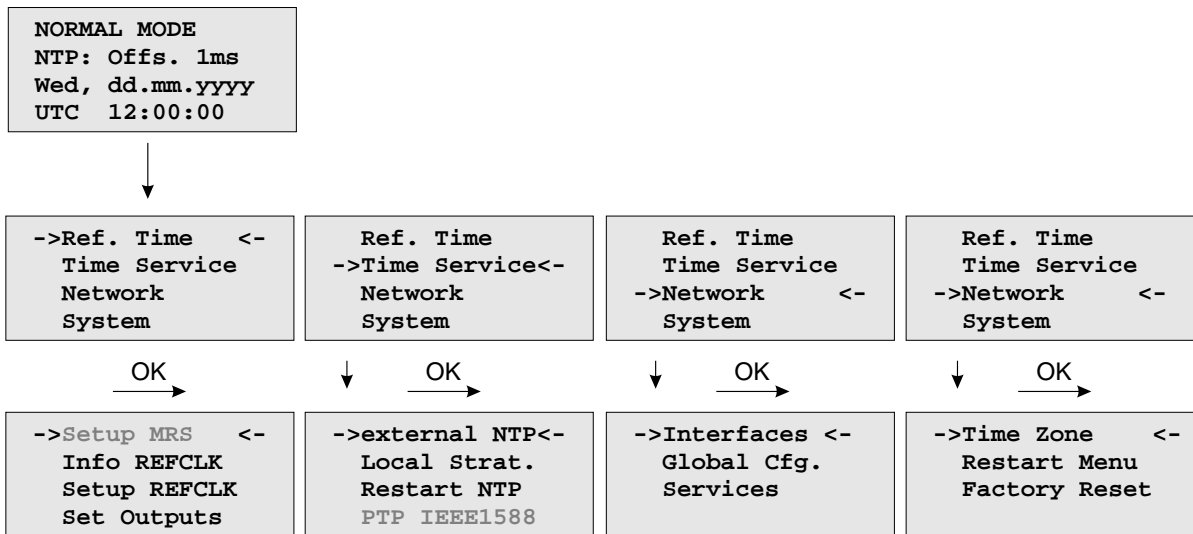

9.2.3 Menu: Reference Time

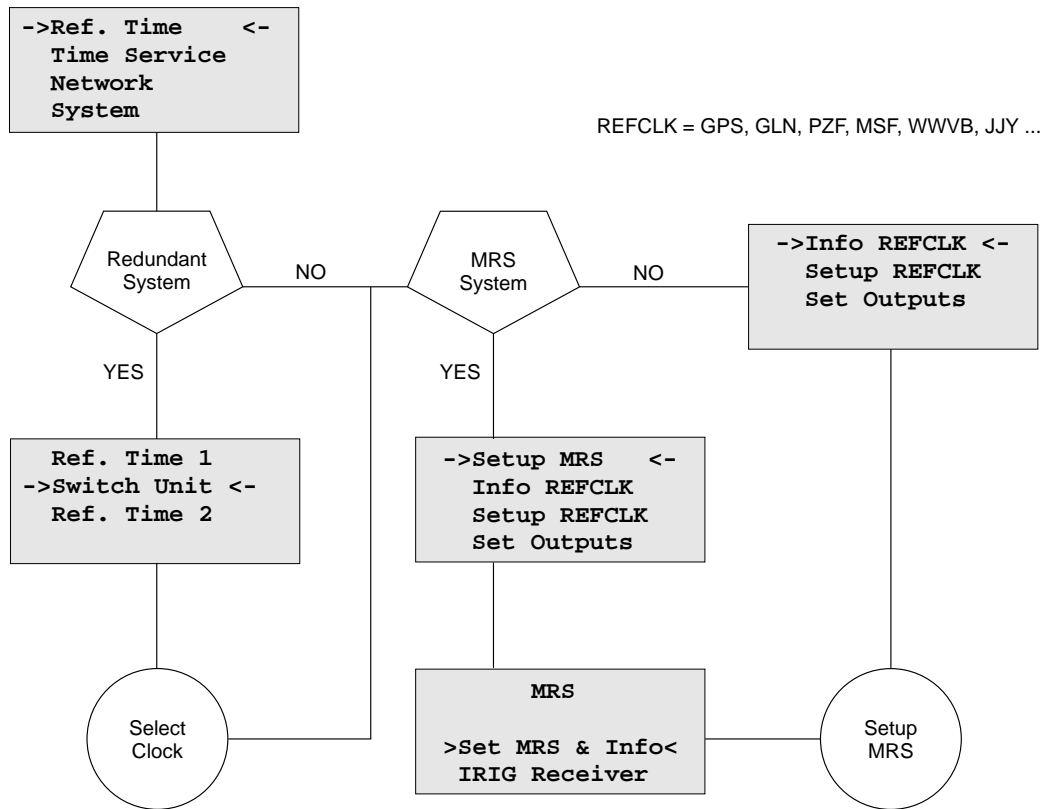

The Reference Clock menu and all its sub menus will manage all status information and parameters of the reference clock. To enter the following sub menus press the "OK" button.

9.2.3.1 Optional Menu Switch Unit

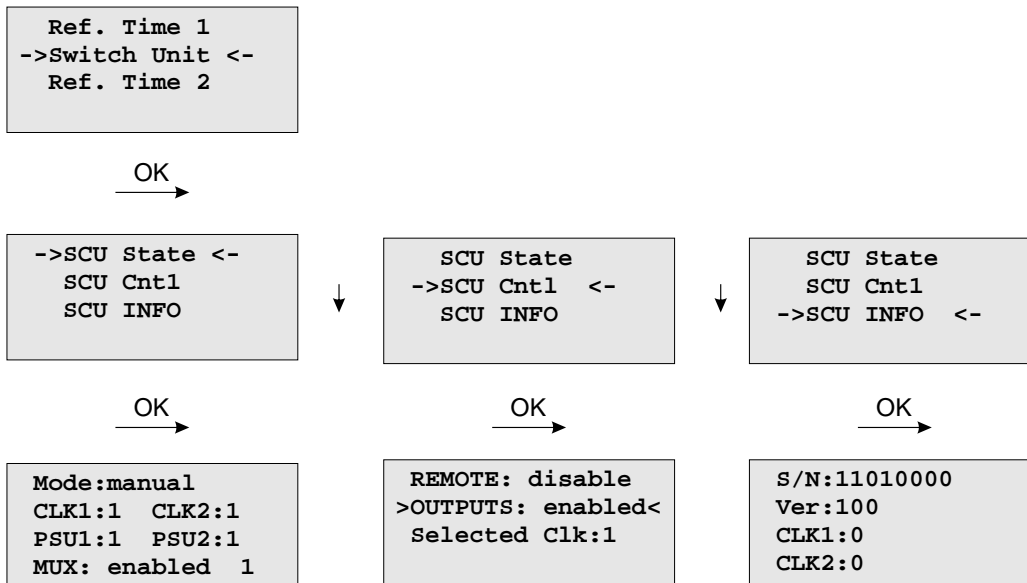

With this menu you can check all important status information about the switch card unit. The example above shows a perfect mode of operation. Both power supplies (PSU1, PSU2) are connected - the two receivers are working in "normal operation mode" (CLK1, CLK2). If the second clock is not connected or in free running mode, the display shows "CLK2:0". If there is no power connected on PSU1, you can see the status "PSU1:0" on the display of the LANTIME.

With the submenu **SCU Cntl** you can configure the following parameters:

REMOTE: disabled/enabled
disable or enable remote control of the SCU

OUTPUTS: enabled/disabled
disable or enable outputs of the SCU

Selected Clk: Clk:1, Clk:2
The reference clock can be selected with the function keys or from a connected workstation - for this the mechanical switch in front of the SCU card must be locked in position "Auto". Otherwise (position "Manual") the selected clock can only be changed by using the switch of the SCU.

9.2.3.2 Menu Option Setup MRS

The internal reference clock of the integrated clock module with the high precision oscillator (OCXO HQ) can be disciplined by different time sources. Possible time sources are GPS receiver, external Pulse Per Second (PPS), IRIG 10MHz Frequency, IRIG Time Code, external NTP server or IEEE1588 Grandmaster (M400, M600, M900). The priorities for the internal controlling can be set up in configuration. The priority will define which reference source will be used next if the highest priority reference source will be no longer available. For each reference source a bias (fixed offset) and a precision value can be defined.

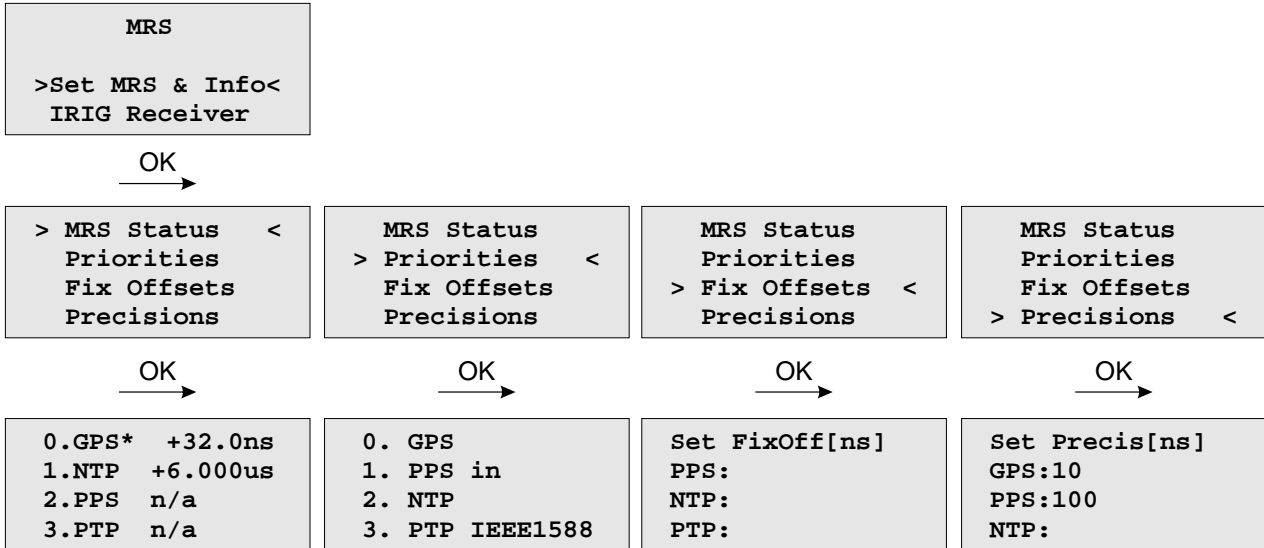

With the OK and arrow buttons you can choose the current status of the MRS. All possible reference clocks will be shown with the number of priority, the name of the reference clock and the current offset to the internal reference clock (OCXO). The current master will be signed with an "*" behind the name of the reference clock.

In the next menu the user can define in which order the references will be used to control the internal oscillator. The reference clock with the highest priority will be used always if this is available.

The "Fixed Offsets" can be set up in the next sub menu, if you know the constant offset (bias) of an external reference source. By default this value is 0 ns. The bias of the internal GPS receiver can not be set up – indirectly this can be done via the antenna cable length.

This precision value will determine the hold over time when switching to the next reference clock if the current master is not available anymore. If the precision is 0 the next reference clock will be switched at once. If the precision value is greater than 0 the time for switching to the next reference (hold over time) will be calculated by the following formula:

$$(\text{precision of next reference}) / (\text{precision of current master}) * \text{constant [s]}$$

The parameter „constant“ depends on the quality of the internal oscillator.

Example:

The GPS receiver with an precision of 10ns is the current master. If this master is no longer available it will switch to the next reference source of the priority order – in this case the PPS input with a precision of 100us. With the formula $((100\text{ns}/10\text{ns}) * 11.4)$ we get hold over time of 114 seconds/1.9 min. The online display of the MRS status will show the remaining time and the calculated time. The hold over time will be recalculated if the status of the reference clocks will change.

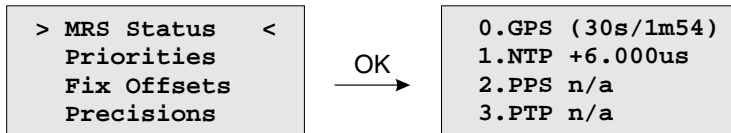
**9.2.3.3 Menu Option MRS - Setup Time Code Receiver**

With this menu, the parameters for the time code input signals can be displayed and adjusted.

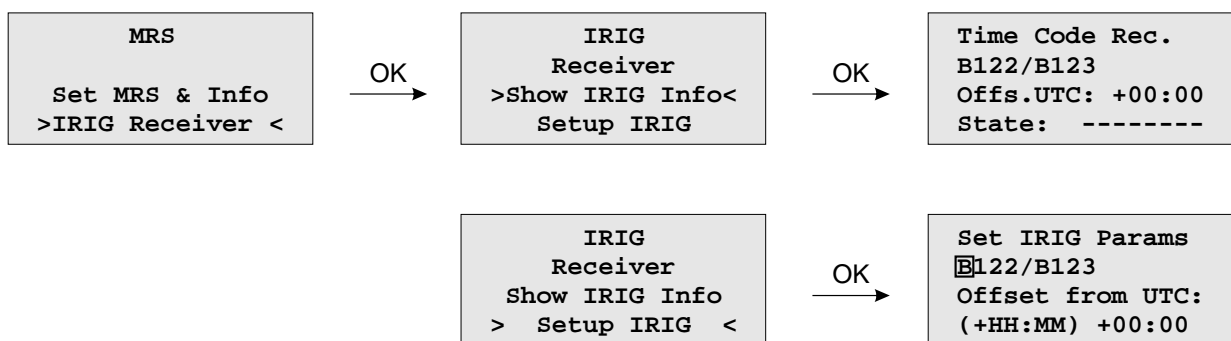

9.2.3.4 Menu: Info Receiver

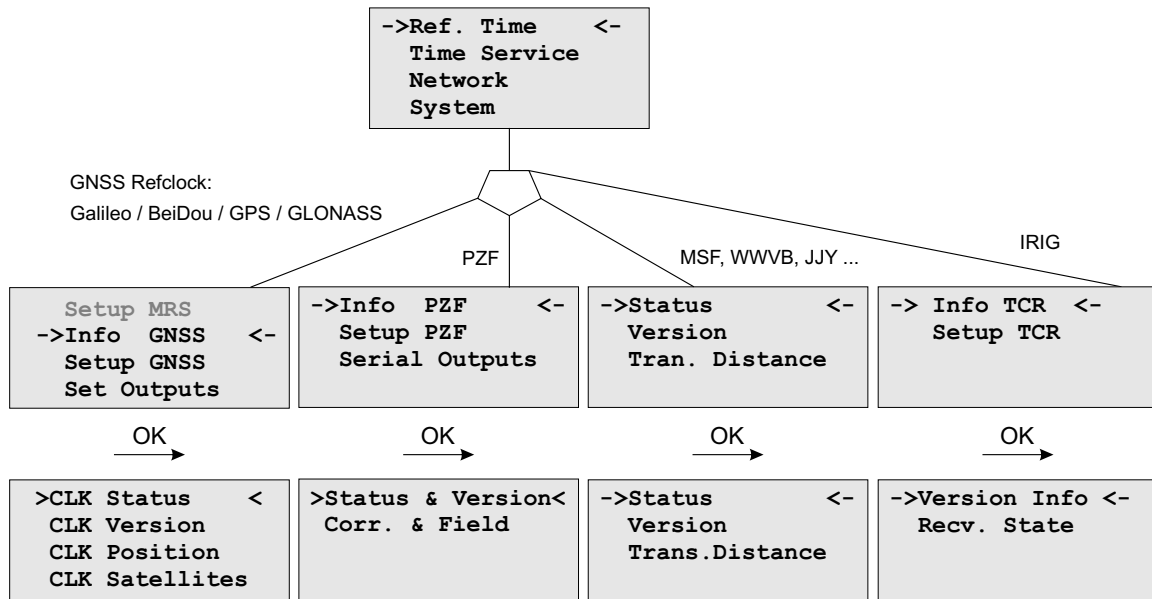

In this menu all relevant information about the reference clock, the internal oscillator and in case of a GNSS receiver, the visible and good satellites will be shown in the display.

9.2.3.5 Receiver Status and Version

GPS / GLONASS (CLK)

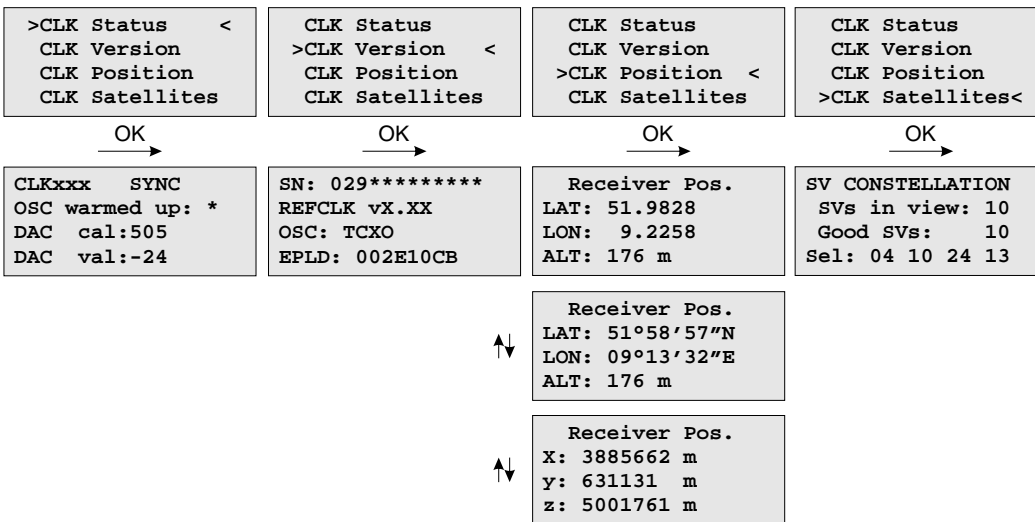

PZF

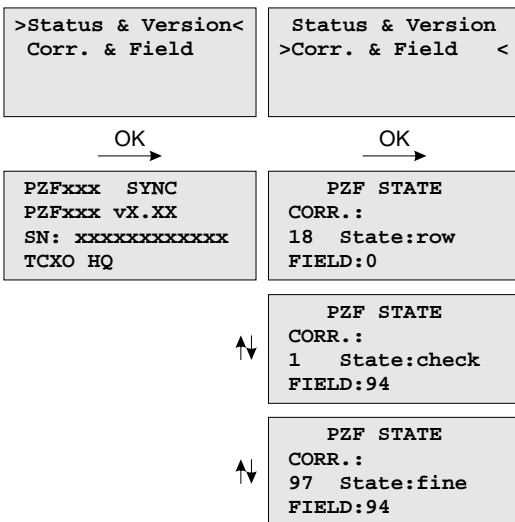

WWVB, MSF, JYJ ... (REF)

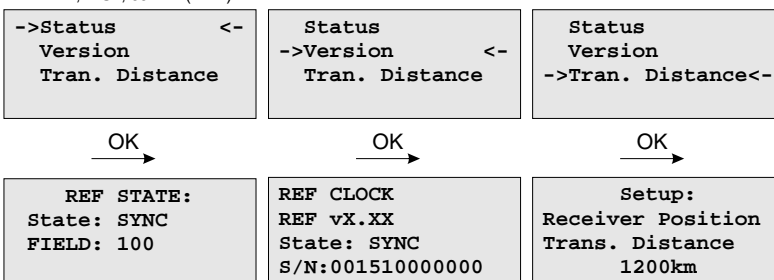

This first menu will monitor the current state („sync“ or „not sync“). The next line will reflect the firmware version, the serial number of the internal GPS and the type of the integrated oscillator.

9.2.3.6 Menu: IRIG Receiver State

The first line of the display shows the system state with 8 options – described in the next paragraph. The second line will display the drift in [us] of the internal oscillator and the TFOM value (Time Figure Of Merit: the quality of the IRIG-signal, only used with IEEE 1344) and the current system configuration is shown on the third line. On the fourth line the AGC (Automatic Gain Control of the input signal) value in hexadecimal will be shown.

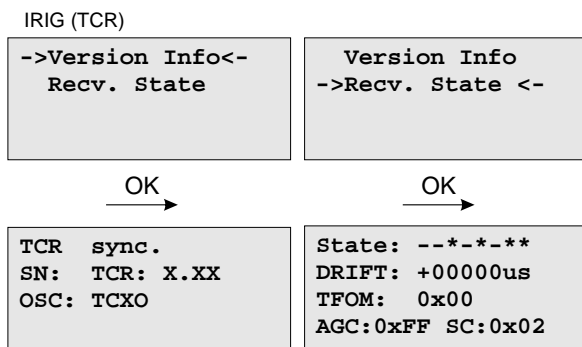

IRIG Receiver State: Bit 7 ... 0

Bit 7: Invalid UTC parameter
 Bit 6: TCAP exceeded, jitter out of range
 Bit 5: Lock on
 Bit 4: Telegramm error
 Bit 3: Data available
 Bit 2: Invalid sysconf
 Bit 1: Pulses enabled
 Bit 0: Warmed up

Invalid UTC parameter: This bit is set to one if the checksum of the 'Offset from UTC' parameter, which must be used if no IEEE1344 extensions are available, is invalid. User must enter new 'Offset from UTC' data to clear this bit. Please note that the IRIG-receiver never leaves freewheeling mode if IEEE1344 is disabled and the UTC-Parameter are invalid!

TCAP exceeded, jitter out of range: If the jitter between two consecutive IRIG-telegrams exceeds +/- 100us the receiver switches into freewheeling mode and the 'TCAP exceeded' Bit is set. 'TCAP exceeded' is cleared if the measured jitter is below +/- 100us.

Lock on: 'Lock On' is set whenever the receiver is in synchronous mode and the internal oscillator correction value has settled.

Telegram error: This bit is set if the consistency check of two consecutive IRIG-telegrams fails. The IRIG-receiver switches into free wheling mode if 'telegram error' is set.

Data available: 'data available' is set if the receiver can read the timecode.

Invalid sysconf: If 'invalid sysconf' is set the checksum of the system configuration data is invalid. In this case the default mode 'IEEE1344 disabled' is selected. User must cycle the system or enter a new system configuration in the IRIG-parameter menu.

Pulses enabled: The pulse per second (PPS) signal which increases the NTP's accuracy is turned when 'lock on' is set the first time. The 'pulses enabled' bit is set if the PPS signal is enabled.

IRIG system configuration Bit 2 ... 0

Bit 7 ... 4: reserved
 Bit 3: ignore Day Of Year enabled
 Bit 2: ignore TFOM
 Bit 1: ignore SYNC
 Bit 0: IEEE 1344 enabled

9.2.3.7 Menu: Setup Meinberg Receiver

GPS / GLONASS (CLK)

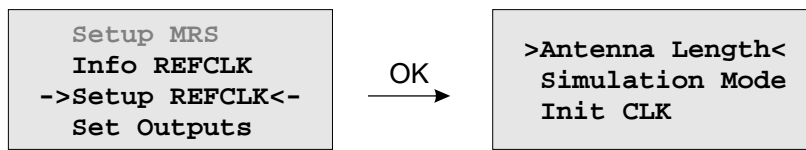

PZF

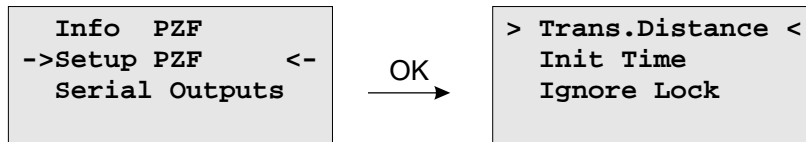

WWVB, MSF, JJY ...

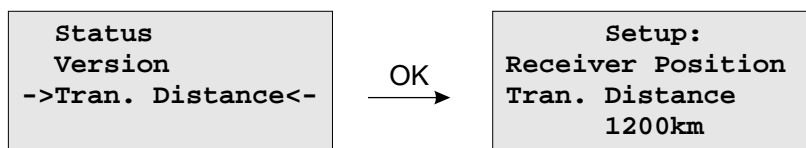

IRIG

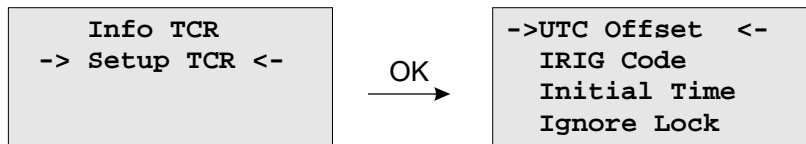

In the Reference Time -> Setup Clock menu the receiver clock parameters can be configured. The antenna cable length of satellite based receivers must be entered here. The GPS and GLONASS reference clocks can be run in simulation mode.

Meinberg's PZF correlation receivers can be operated in simulation mode as well. In addition to that, the distance to the transmitter must be set in the setup menu.

For our long wave receivers (WWVB, MSF, JJY ...) there is only the setting for "Transmitter Distance" available - in the Submenu *Reference Time* -> *Info Refclock*. The setup for our IRIG time code receivers includes the settings for the UTC offset and the corresponding time code. The time code receiver can also operate in simulation mode with **IGNORE LOCK**. With **Initial Time** and **Init Clock** (GPS, GLONASS), the time and date for the simulation mode is set.

9.2.3.8 SNS Mode - Satellite Navigation System Mode

If you are using a GNS receiver (GNS or GNS-UC with Up Converter), this drop-down menu allows you to select one or more satellite systems to be used simultaneously. The following combinations are available:

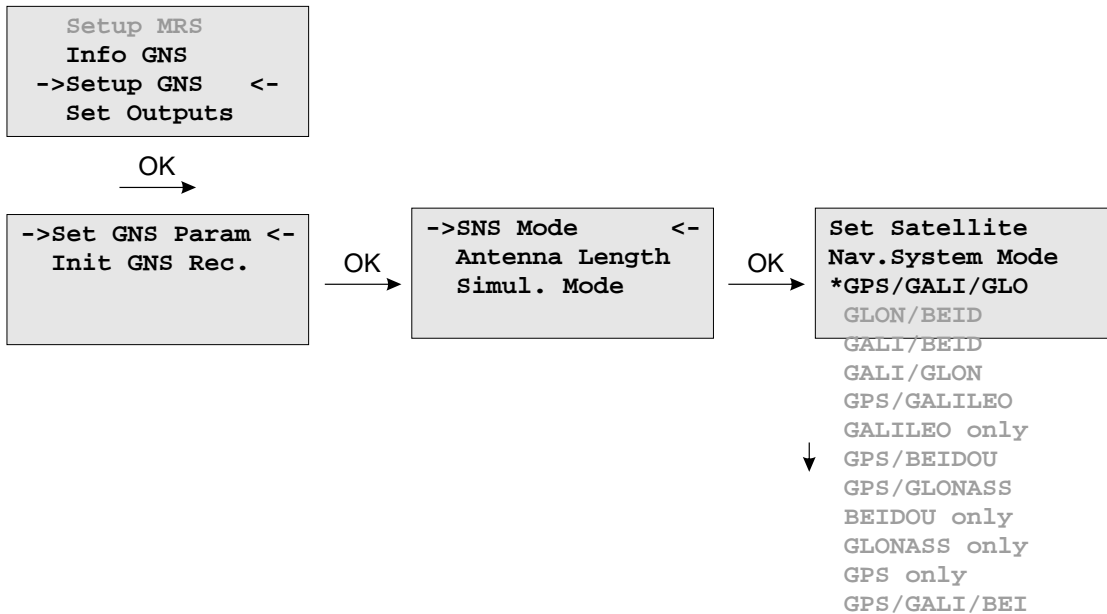

9.2.3.9 Initiate Cold Boot

This menu lets the user initialize all GNSS data, i.e. all saved satellite data will be cleared. The user has to acknowledge this menu again before the initialisation starts. The system starts operating in the COLD BOOT mode and seeks for a satellite to read its actual parameters.

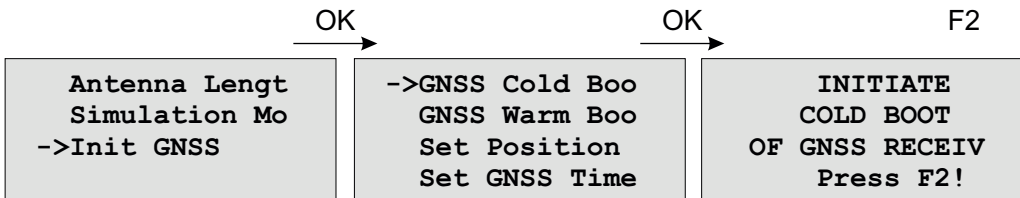

9.2.3.10 Initiate Warm Boot

This menu lets the user force the receiver into the Warm Boot Mode. This may be necessary when the satellite data in the memory are too old or the receiver position has changed by some hundred kilometres since last operation. Synchronisation time may be reduced significantly. If there is valid satellite data in the memory the system starts in the Warm Boot mode, otherwise the system changes into Cold Boot to read new data.

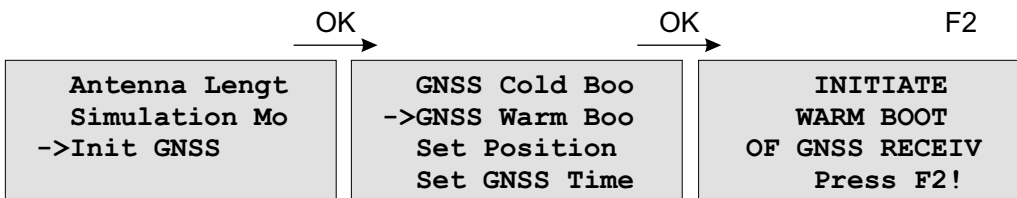

9.2.3.11 Init Receiver Position

When the receiver is primarily installed at a new location far away from the last position saved in the receiver's memory the satellites in view and their doppler will differ so much from those expected due to the wrong position that the GNSS receiver has to scan for satellites in Warm Boot mode. Making the new approximately known position available to the receiver can avoid Warm Boot and speed up installation.

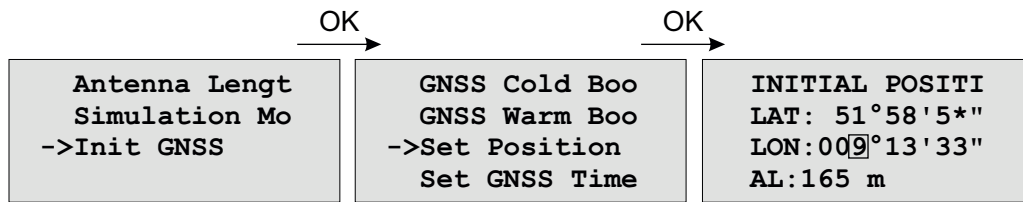

9.2.3.12 Init Receiver Time

If the receiver's on-board real time clock keeps a wrong time the receiver is unable to compute the satellites' correct elevation angles and Doppler. This submenu enables the user to change the receiver's system time for initialisation. After the receiver has locked, its real time clock will be adjusted using the information from the satellites.

When the antenna is disconnected it is possible to set the system with any time. Note that the NTP will not synchronize to GNSS losing its reception or if the deviation to the system time is larger than 1024 seconds. In this case the menu **Simulation Mode** has to be active. After setting the clock manually the system time will be set and the NTP will be restarted.

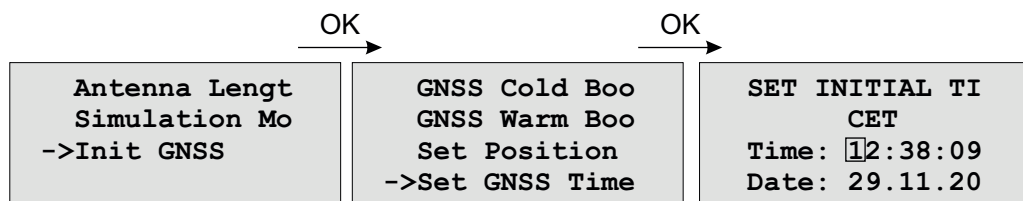

9.2.3.13 Menu: Output Options

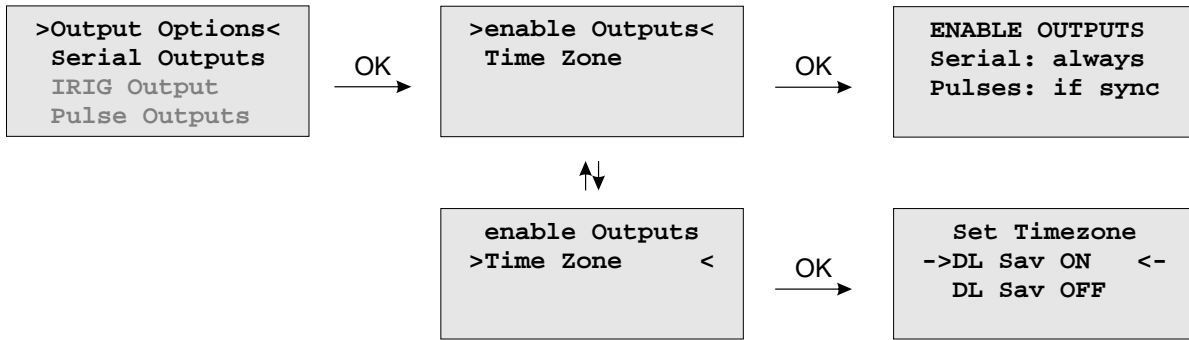

Enable Outputs:

The submenu *Output Options* -> *Enable Outputs* lets the user configure at which time after power up the serial ports and pulse/frequency outputs are to be enabled. Outputs which are shown to be enabled 'always' will be enabled immediately after power-up. Outputs which are shown to be enabled 'if Sync' will be enabled after the receiver has decoded the incoming signals and has checked or corrected its on-board clock. The default setting for all outputs is 'if Sync'.

Time Zone:

See Chapter "Set Time Zone of Serial Outputs".

9.2.3.14 Menu: Serial Outputs

This menu lets the user configure the baud rate and the framing of the serial RS232 port to one of the following values:

Baudrate: 300 to 19200
Dataformat: 7E1, 7E2, 7N2, 7O1, 7O2, 8E1, 8E2, 8N1, 8N2, 8O1

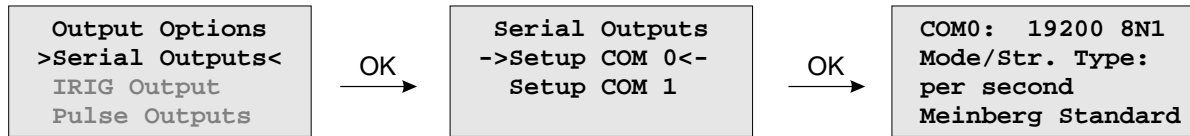

COM0 provides a time string once per second, once per minute or on request. If the „on request“ is activated you have to send the character "?" to get the timestring.

| Defaultsettings COM0: | Speed | Framing | Mode | Signal Type |
|-----------------------|------------|---------|------------|-------------------|
| | 19200 baud | 8N1 | per second | Meinberg Standard |

This topic is used to select one of several different types of serial time strings or the capture string for each serial port.

The following time strings can be selected. All time strings are described in the appendix at the end of this documentation.

- Meinberg Standard
- SAT
- NMEA RMC (Rev. 2.2)
- Uni Erlangen
- Computime
- Sysplex 1
- Meinberg Capture
- SPA
- RACAL
- Meinberg GPS
- NMEA GGA (Rev. 2.2)
- NMEA RMC GGA (Rev. 2.2)
- NMEA ZDA (Rev. 2.2)
- ION
- 6021
- IRIG-J

9.2.3.15 Setup Output Time Zone

The time zone of the internal receiver can be set up. These parameters will affect the serial output lines and the timecode (IRIG) outputs. The internal time zone of the timeserver and the time of NTP will always be UTC. The time monitored in the main menu will be the time of the NTP.

The menu *Set Timezone* lets the user enter the names of the local time zone with daylight saving disabled and enabled, together with the zones time offsets from UTC. These parameters are used to convert UTC to local time, e.g. CET = UTC + 1h and CEST = UTC + 2h for central Europe. The values of daylight saving are configurable using the Time Zone setup menu.

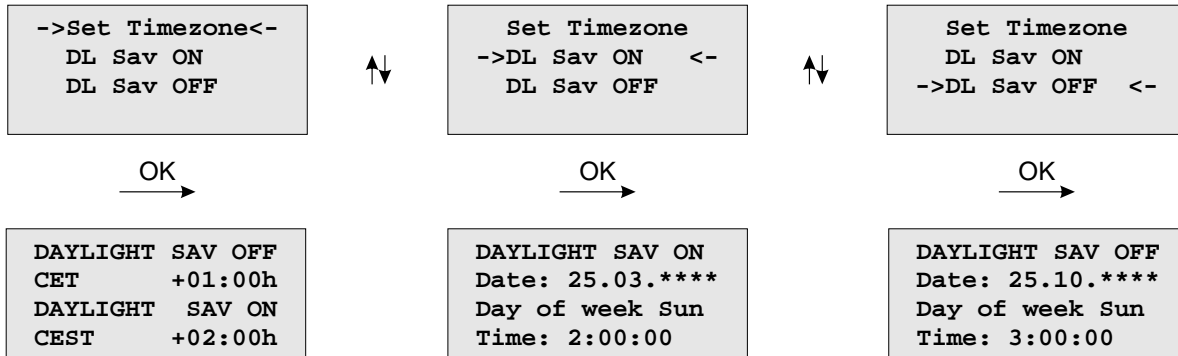

Beginning and ending of daylight saving may either be defined by exact dates for a single year or using an algorithm which allows the receiver to re-compute the effective dates year by year. The figure shows how to enter parameters for the automatic mode. If the number of the year is displayed as wildcards '****', a day-of-week must be specified. Then, starting from the configured date, daylight saving changes the first day which matches the configured day-of-week. In the figure October 25th is a Saturday, so the next Sunday is October 26th.

All changeover rules for the daylight saving like "the first/the second/the second to last/the last Sunday/-Monday etc. in the x-th month," can be described by the used format "first specified day-of-week after a defined date".

If the number of the year is not displayed as wildcards the complete date exactly determines the day daylight saving has to change, so the day-of-week does not need to be specified.

If no changeover in daylight saving is wanted, identical dates and times must be entered in both of the submenus (DAYLIGHT SAV ON/OFF). After this a restart should be done.

9.2.3.16 Menu: Setup Time Code

The IRIG Time Code is an optional output.

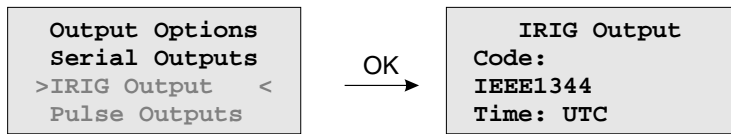

This menu lets the user select the Timecodes to be generated by internal reference clock. Most IRIG-Codes do not carry any time zone information, hence UTC is selected for output by default. If desired, the clocks local time can be output by selecting "TIME: Local".

The following codes can be selected:

- IRIG B002+B122
- IRIG B006+B126
- IRIG B007+B127
- AFNOR NF S87-500
- C37.M8
- IEEE1344

Refer to chapter **Timecode** for details.

9.2.3.17 Option: Setup Progr. Pulses

Timer Mode

This mode simulates a programmable day assigned timer. Three turn-off and turn-on times are programmable for each output. If you want to program a switchover, change the turn-on time "On" and the corresponding turn-off time "Off". A turn-on time later than the turn-off time would cause a switch program running over midnight. For example a program "On"10.45.00, "Off" 9.30.00 would cause an active output from 10.45 to 9.30 (the next day!). If one or more of the three switching times are unused just enter the same time into the values "On" and "Off". In this case the switch time does not affect the output.

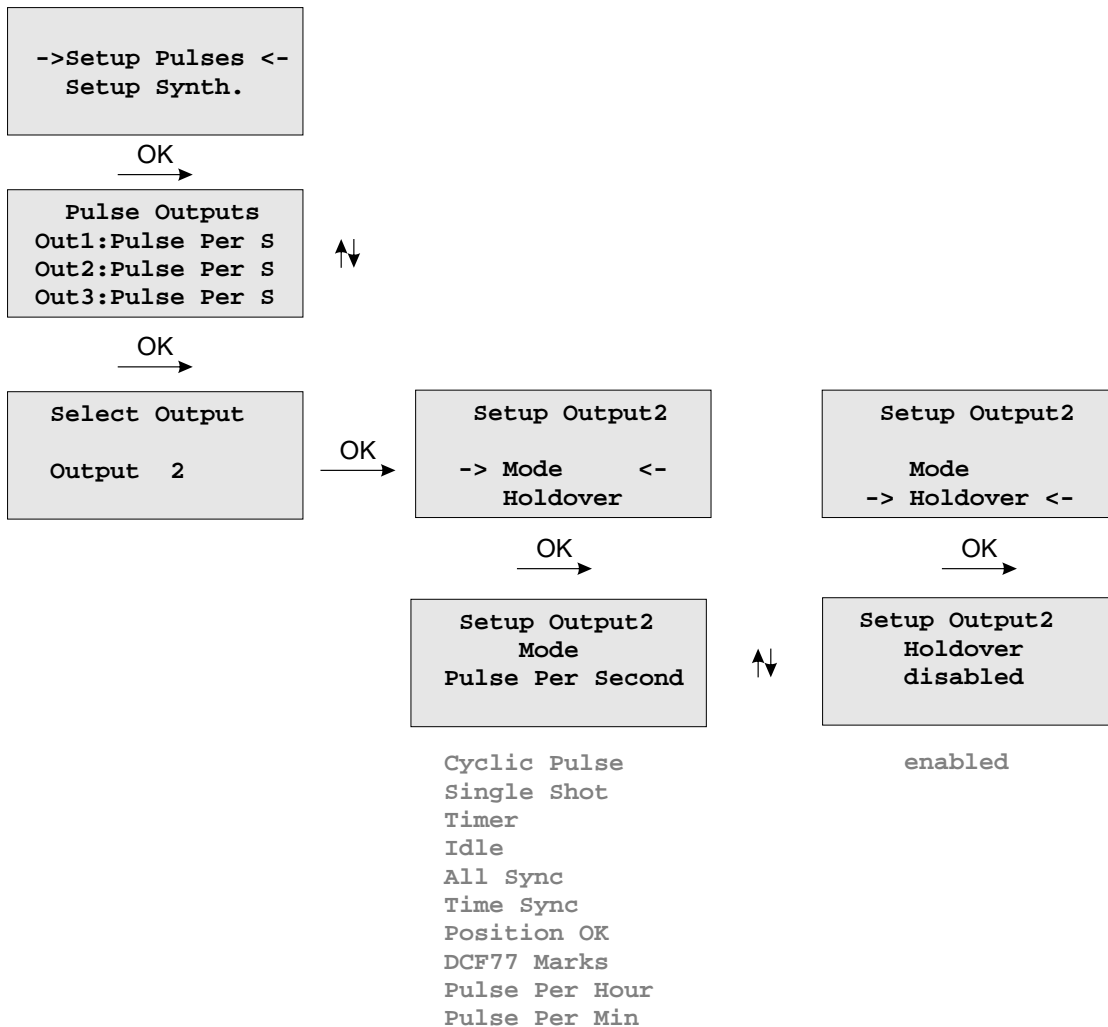

As already mentioned, the outputs home position is selected by "active: high or low".

Cyclic Pulse mode - generating of periodically repeated pulses

The value of "Time" determines the time between two consecutive pulses. This cycle time must be entered as hours, minutes and seconds. The pulse train is synchronized at 0:00 o'clock local time, so the first pulse of a day always occurs at midnight. A cycle time of 2 seconds for example, would cause pulses at 0:00:00, 0:00:02, 0:00:04 etc. Basically it is possible to enter any cycle time between 0 and 24 hours, however usually a cycle times that cause a constant distance between all consecutive pulses make sense.

For example: a cycle time of 1 hour 45 minutes would cause a pulse every 6300 seconds (starting from 0 o'clock). The appearing distance between the last pulse of a day and the first pulse of the next day (0:00:00 o'clock) would be only 4500 sec. The value in entry field "Cycle" turns red, when entering a time that causes this asymmetry.

DCF77 Marks

In "DCF77 Marks" mode the selected output simulates the telegram as transmitted by german time code transmitter DCF77. The generated time code is related to the local time zone. If you want DCF simulation to be disabled when the clock is in free running mode, you can enter the delay (given in minutes) for deactivat-

ing the DCF-Simulation with the "Timeout" value. DCF Simulation is never suspended, if the delay value is zero.

Single Shot Modus

Selecting Single Shot generates a single pulse of defined length once per day. You can enter the time when the pulse is generated with the "Time" value. The value "Length" determines the pulse length. The pulse length can vary from 10 msec to 10 sec in steps of 10 msec.

Pulses Per Second, Per Min, Per Hour Modes

These modes generate pulses of defined length once per second, once per minute or once per hour. "Length" determines the pulse length (10 msec...10 sec).

Position OK, Time Sync and All Sync

Three different modes are selectable for output of the clocks synchronization state. The Mode 'Position OK' activates the output when the receiver has sufficient satellites in view to calculate its position. In "Time Sync" mode the respective output is activated when the clocks internal timebase is synchronized to the GPS timing. The "All Sync" Mode performs a logical AND operation of the both states previously mentioned, i.e. the output is activated if the position can be calculated AND the internal timebase is synchronized to the GPS timing

Idle Mode

Selecting "Idle" deactivates the output.

Holdover

If "enabled" is selected the operation of the output remains. Otherwise ("disabled") the operation of the output will be switched off when synchronization is lost.

9.2.3.18 Option: Synthesizer Frequency Output

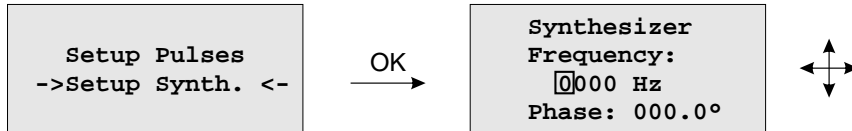

This setup menu lets the user edit the frequency and phase to be generated by the on-board synthesizer. Frequencies from 1/8 Hz up to 10 MHz can be entered using four digits and a range. The range can be selected if the „UP“ or „DOWN“ key is pressed while the cursor is positioned on the frequency's units string. If the least significant range has been selected valid fractions of the frequency are .0, .1 (displayed as 1/8), .3 (displayed as 1/3), .5 and .6 (displayed as 2/3). Selection of 1/3 or 2/3 means real 1/3 or 2/3 Hz, not 0.33 or 0.66. If frequency is set to 0 the synthesizer is disabled.

The last line of the display lets the user enter the phase of the generated frequency from -360° to $+360^\circ$ with a resolution of 0.1° . Increasing the phase lets the signal come out later. Phase affects frequencies less than 10.00 kHz only, if a higher frequency is selected a message "(phase ignored)" informs the user that the phase value is ignored.

9.2.4 Menu: Time Service

The NTP configuration page is used to set up the additional NTP parameters needed for a more specific configuration of the NTP subsystem. The optional available PTP adjustments can be done with this menu.

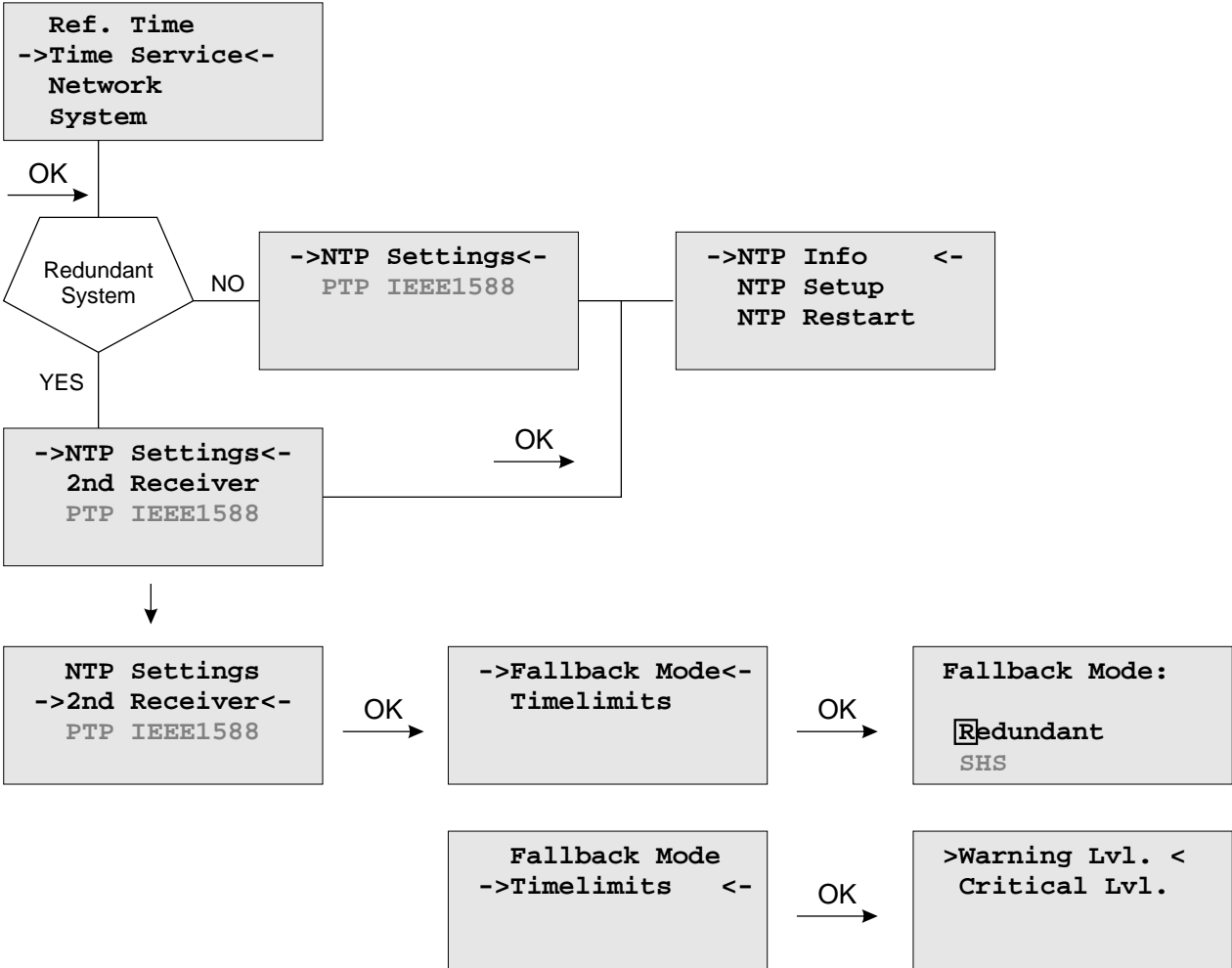

9.2.4.1 Menu NTP

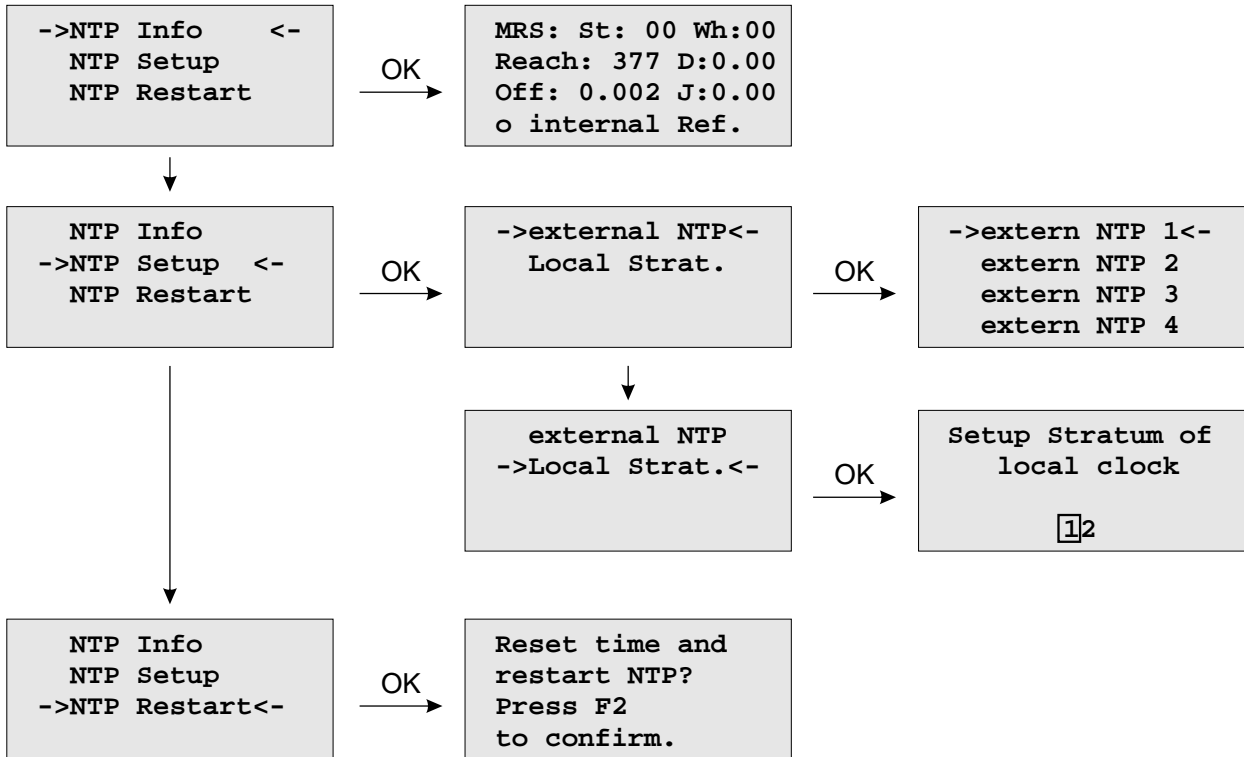

9.2.4.2 Menu: external NTP

Additional external NTP servers can be set up to provide a high grade of redundancy for the internal reference clock.

The internal reference clock always has priority over the external NTP servers. If the internal reference clock is not synchronized or has failed, the NTP will automatically switch to an external NTP server. With this menu item some external NTP server can be configured.

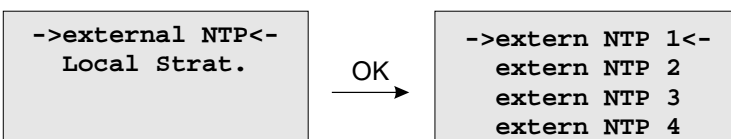

9.2.4.3 Menu: Stratum of local clock

The local clock is only chosen as the NTP time reference after the reference clock lost its synchronisation. The stratum level of the local clock is set to 12, this ensures that clients recognise the switchover to the local clock and are able to eventually take further actions. The local clock can be disabled if the timeserver should not answer anymore when the reference clock is out of order. The field "Stratum of local clock" is used to change the stratum level of the local clock, default value is 12.

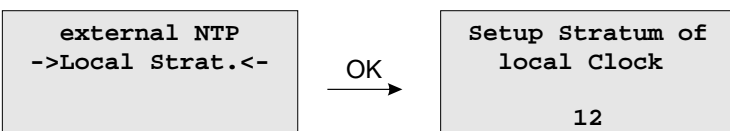

9.2.4.4 Menu: Restart NTP

The system time is setup, together with the reference time and the NTP service is rebooting.

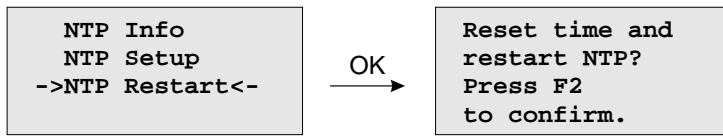

9.2.4.5 Option: Menu PTPv2 - IEEE 1588-2008

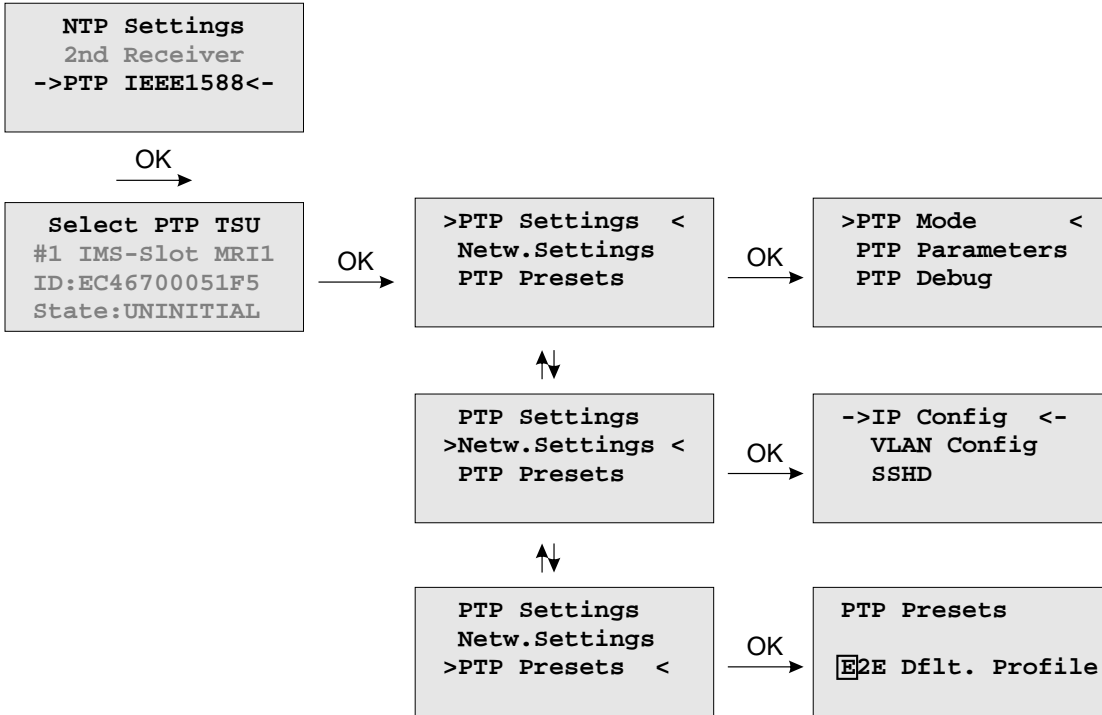

The menu for PTP IEEE 1588 configuration is located in the "Time Service" main menu. A device with more than one PTPv2 cards (also called TSU - Time Stamp Units) lists all cards in the sub menu which follows. With ↓ and ↑ buttons one can select among different PTP cards available in the system. A slot number, MAC address and the current state of the selected TSU will be displayed.

9.2.4.6 Menu TSU Info

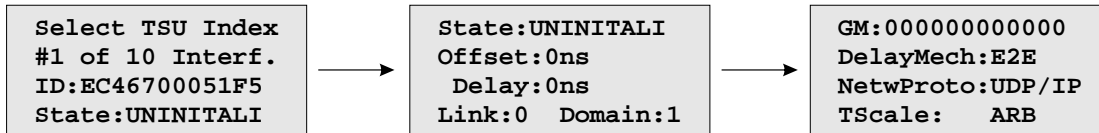

The page "TSU Info" gives an overview of the state of the most important PTP parameters from the time stamp unit which is connected to the PTP0 interface. The appearance of this page is depending on the mode of the PTP engine. There are different states of a TSU possible. For example, if the unit is configured as a PTP Grandmaster clock, then this page shows the "Master" state. On the other hand in MRS (Multi Reference Source) devices, the PTP mode "Slave" is displayed here.

The full list of **TSU States** is as follows:

- uninitialized:* The port is booting up, the software daemon has not yet started, the IP address is not yet assigned.
- initializing:* In this state the port initializes its data sets, hardware, and communication facilities.
- faulty:* Not defined in LANTIME systems.
- disabled:* PTP service has been disabled on this port, either by user configuration or because the module is in a standby mode.
- listening:* The port is waiting for the announceReceiptTimeout to expire or to receive an Announce message from a master.
- preMaster:* A short transitional state while the port is becoming a master.
- master:* The port is a current master.
- passive:* The port is in passive mode, meaning there is another master clock active in the PTP domain. The port can enter master state when it wins the BMCA (Best Master Clock Algorithm) due to a failure/service degradation of the current master.
- uncalibrated:* One or more master ports have been detected in the same domain. The TSU is waiting to calculate the path delay to a Grandmaster.
- slave:* The port has successfully subscribed to a master and receives all expected messages. It also successfully measured the path delay using delay request messages.

Values **Offset** and **Delay**

"Master" state: 0 ns since they refer to its internal clock.

"Slave" state: they show the offset to the Grandmaster and the mean network delay between the master and a slave.

Link: status 0: The queried port is down, check the link LED. If faulty, replace the network card.
status 1: The port of interest is in normal operation.

- Domain:** A PTP domain is a logical group of PTP devices within a physical network that belong to the same domain number. Slave devices that shall sync to a certain master within a network must have been configured with a unique domain number which is the as same on the master.
- GM:** A MAC address of the current Grandmaster.
- DelayMech:** two options possible:
E2E (End-to-end) where delay measurement messages are sent from the slave to the master (the two end nodes).

P2P (Peer-to-peer): where each device (a peer) in the network exchanges peer-delay measurement messages. This way each device can keep track of the delays between itself and its immediately connected neighbors. P2P mechanism can be used in 1588 PTP-capable networks only.
- NetwProto:** two options possible:
ETH-IEEE 802.3 / Ethernet (Layer 2): Ethernet frame including MAC addresses of a destination and a source.

UDP-UDP/IPv4 (Layer 3): User Data Protocol one of the main protocols used for the Internet.

9.2.4.7 Menu TSU Setup

With this menu, all PTP parameters can be configured for the selected interface:

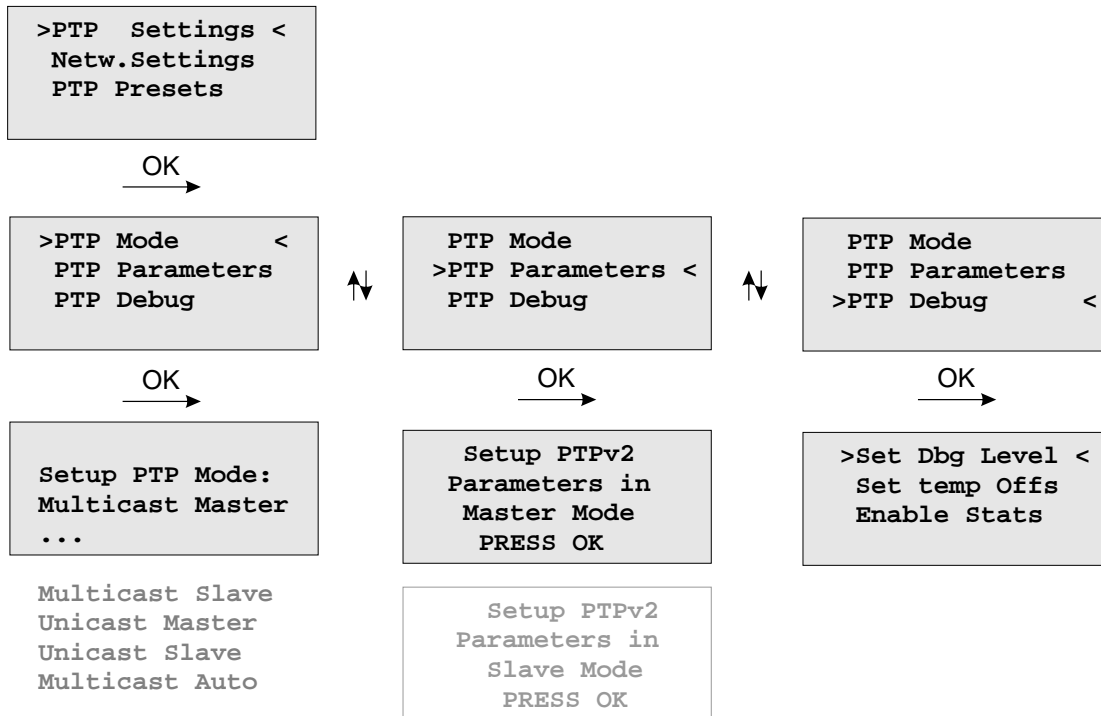

The **Set Dbg Level** menu is for maintenance and debugging purposes only, therefore leave it unchanged unless advised by a technician. The Level of debugging can be increased from 0 (default) to 3 with additional data being logged at each increased debugging level.

Set temp Offs is an offset value set temporarily, mainly for a debugging purpose. With the next warm boot the value is set back to 0.

Enable Stats option is also mainly for debugging. Per default it is disabled.

9.2.4.8 Menu PTP Mode

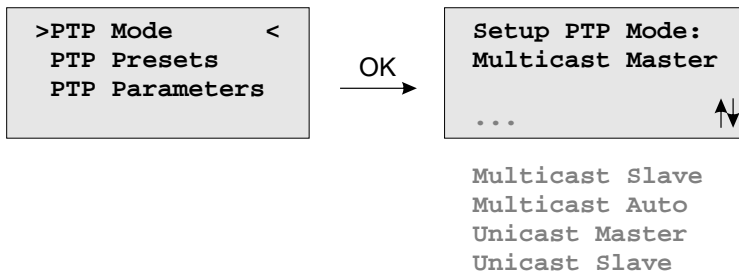

The number of different PTP operation modes depends on the feature set of the purchased unit.

Supported modes on a GPS-only or GPS/GLONASS-only system:

- PTPv2 Multicast Master
- PTPv2 Unicast Master

Supported Modes on a MRS system:

- PTPv2 Multicast Slave
- PTPv2 Multicast Master
- PTPv2 Multicast Auto
- PTPv2 Unicast Slave
- PTPv2 Unicast Master

9.2.4.9 Load PTP Presets

Each PTP preset represents a set of PTP configuration parameters that will switch the PTP engine to a dedicated PTP profile. After a preset has been selected, the user still has the opportunity to change all PTP parameters and "fine-tune" them.

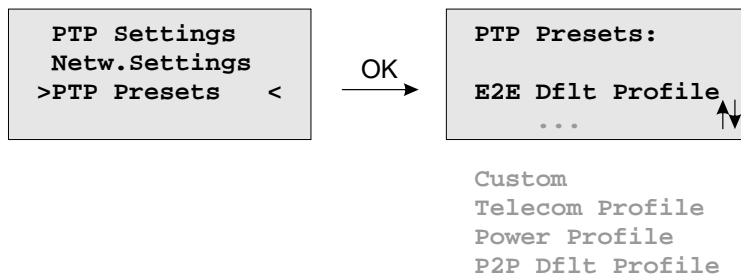

Note: Whenever a PTP preset is selected, all previously saved PTP parameters will be overwritten!

Six different presets are supported:

In Multicast Master / Slave Mode:

Delay Request Response Default Profile

- Sync Msg Rate: 1/sec
- Ann Msg Rate: 2 sec
- Priority 1: 128
- Priority 2: 128
- Delay Mech: "E2E"

Peer-to-Peer Default Profile

- Sync Msg Rate: 1/sec
- Ann. Msg Rate: 2 sec
- Priority 1: 128
- Priority 2: 128
- Delay Mech: "P2P"

Power Systems Profile

- Sync Msg Rate: 1/sec
- Ann Msg Rate: 1/sec
- Priority 1: 128
- Priority 2: 128
- Delay Mech: "P2P"
- VLAN (802.1Q) enabled (VLAN ID:0, Prio:4)
- Power Profile TLVs enabled

Telecom ITU-T G.8275.1

- Ann Msg. Rate: 8/sec
- Sync Msg. Rate: 16/sec
- Del Req Rate: 16/sec
- Priority 1: 128
- Priority 2: 128
- Delay Mech: "E2E"
- Network Prot. "Layer 2 (IEEE 802.3)"

In Unicast Master / Slave Mode:

Telecom ITU-T G.8265.1

- Ann Msg. Rate: 1/sec
 - Sync Msg. Rate: 16/sec
 - Del Req Rate: 16/sec
 - Priority 1: 128
 - Priority 2: 128
 - Delay Mech: "E2E"
 - Network Prot. "Layer 3 (UDP/IPv4)"
-

In Unicast or Multicast Master / Slave Mode:

SMPTE ST 2059-2

- Ann Msg. Rate: 4/sec
- Sync Msg. Rate: 8/sec
- Del Req Rate: 8/sec
- Priority 1: 128
- Priority 2: 128
- Delay Mech: "E2E" or "P2P"

Custom Profile

By selecting "Custom" settings all parameters are ready for editing.

9.2.4.10 PTP Parameters

Depending on the selected mode, different sub menus will appear for configuring the PTP parameters.

MULTICAST MASTER

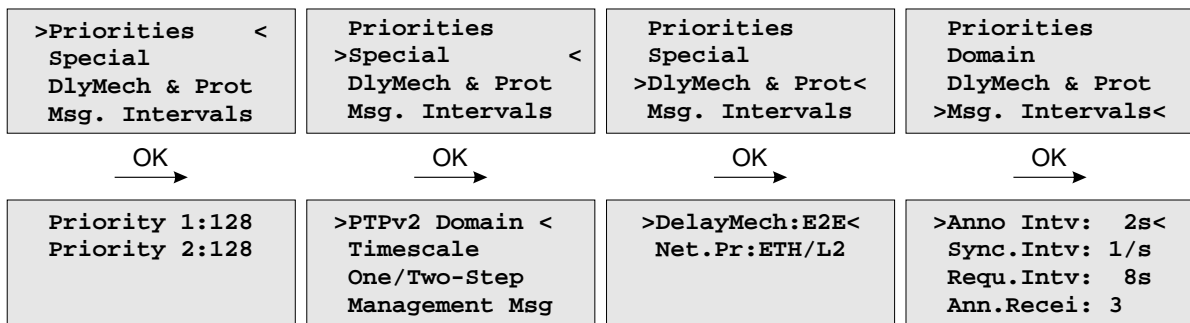

UNICAST MASTER

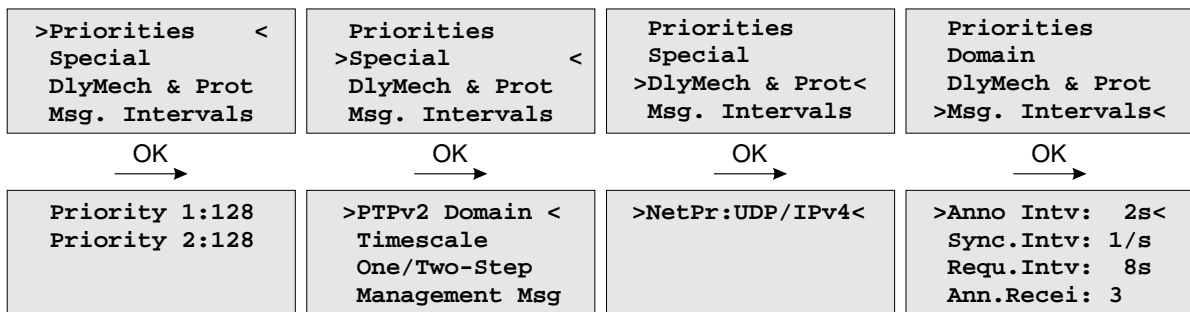

MULTICAST SLAVE

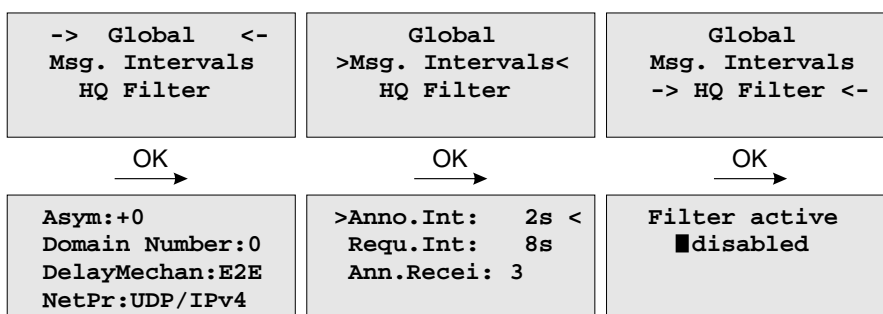

UNICAST SLAVE

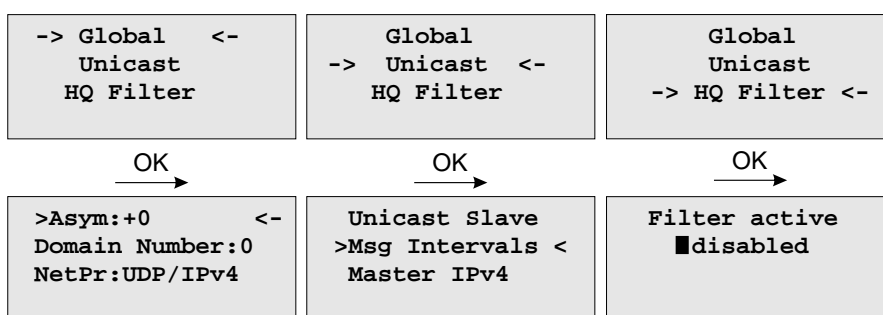

9.2.4.11 Multicast Master

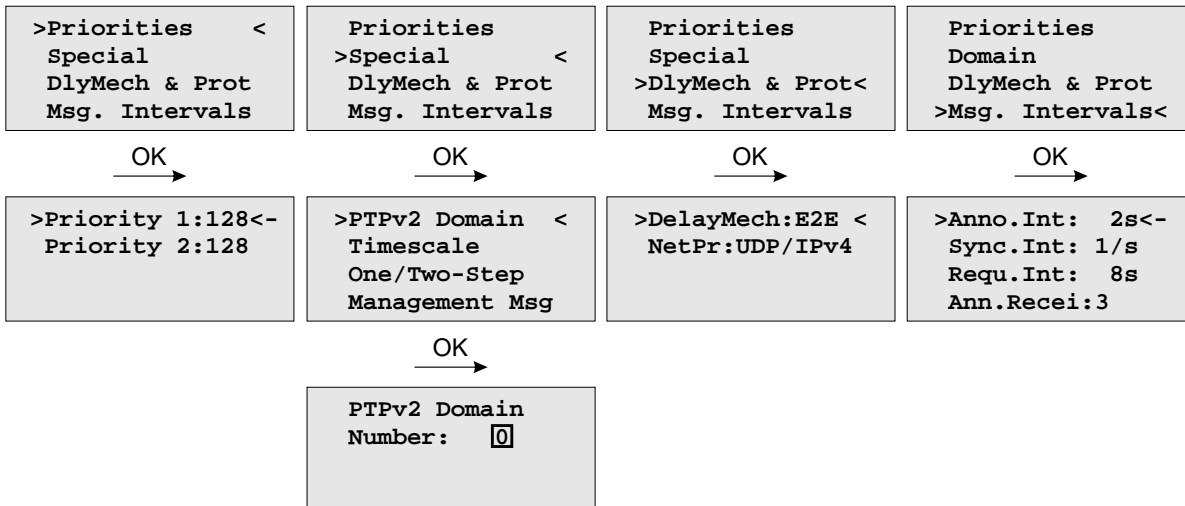

In Multicast mode all PTP messages will be sent as Multicast packets where receiving nodes (slave clocks) do not require to know the identity of the time sources in the network. The selection of the active time source (the Grandmaster) follows the so-called "Best Master Clock Algorithm" a mechanism that all participating PTP masters must follow. The multicast communication model requires a minimized configuration of all participating nodes and this advantage is beneficial in smaller networks. In larger networks it is considered inefficient as the content of message is forwarded to all nodes, requiring them to spend network bandwidth and CPU resources.

The following settings can be done in Multicast Master Mode.

Priority1: The attribute is used in the execution of the best master clock algorithm (BMCA). Lower values take precedence.

Configurable range: 0..255.

The operation of the BMCA selects clocks from a set with a lower value of priority1 over clocks from a set with a greater value of priority1.

Priority2: The attribute is used in the execution of the BMCA. Lower values take precedence.

Configurable range: 0..255.

In the event that the operation of the BMCA fails to order the clocks based on the values of priority1, clockClass, clockAccuracy, and scaledOffsetLogVariance, the priority2 attribute allows the creation of up to 256 priorities to be evaluated before the tiebreaker. The tiebreaker is based on the clockIdentity. The values clockClass, clockAccuracy, and scaledOffsetLogVariance depend on the internal state of the grandmaster and cannot be configured.

PTPv2 Domain: A PTP domain is a logical group of PTP devices within a physical network that belong to the same domain number. Slave devices that shall sync to a certain master within a network must have configured a unique domain number which is the same on the master.

Timescale: two options possible:

PTP: In normal operation, the epoch is the PTP epoch and the timescale is continuous. The unit of measure of time is the SI second. The PTP epoch is 1 January 1970 00:00:00 TAI time source.

ARB as arbitrary: In normal operation, the epoch is set by an administrative procedure.

- One / Two Step:** Per default Two Step approach is enabled
 Two Step approach: The PTP protocol requires the master to periodically send SYNC messages to the slave devices. The hardware time stamping approach of PTP requires that the master records the exact time when such a SYNC packet is going on the network wire and needs to communicate this time stamp to the slaves. This can be achieved by sending this time stamp in a separate packet (a so-called FOLLOW-UP message).
 One Step approach: the SYNC message itself is time stamped on- the- fly just before it leaves the network port. Therefore, not FOLLOW-UP message is needed.
- Management Msg:** A protocol within PTP used to query and update the PTP data sets maintained by master clocks. These messages are also used to customize a PTP system and for initialization and fault management. Management messages are used between management nodes and clocks. Per default are enabled.
- DelayMech:** two options possible:
 E2E (End-to-end) where delay measurement messages are sent from the slave to the master (the two end nodes).
 P2P (Peer-to-peer): where each device (a peer) in the network exchanges peer-delay measurement messages. This way each device can keep track of the delays between itself and its immediately connected neighbors. P2P mechanism can be used in 1588 PTP-capable networks only.
- NetPr:** two options for the network protocol are possible:
 ETH-IEEE 802.3 / Ethernet (Layer 2): Ethernet frame including MAC addresses of a destination and a source.
 UDP-UDP/IPv4/IPv6 (Layer 3): User Data Protocol one of the main protocols used for the Internet.
- Msg. Intervals:** specify the settings for the PTP timing messages.
Anno. Intv specifies the time for sending announce messages between masters to select the Grand Master. Available settings are: 16/s, 8/s, 4/s ... 2s, 4s, 8s, 16s with a default value 2 seconds.
Sync. Intv specifies the time for sending sync messages from a master to a slave. Available settings are: 128/s, 64/s ... 64s, 128s, with a default value 1 second.
Requ. Intv specifies an interval how often delay request messages are sent from a slave to the master. Delay request messages intervals 128/s, 64/s,... 64s, 128s, with a default value 2 seconds.
Ann. Recei value specifies the time for announce receipt timeout messages which is 2-10 times the Announce interval, with a default of 3. This is the time for a BMCA to determine a Grand master.

9.2.4.12 Unicast Master

Unicast mode is applicable generally in larger networks to reduce the overall traffic or when the network is not set up to support multicast. Sometimes there is only one slave and one master of interest and they just want to be alone with each other to have a private conversation without other PTP capable devices being involved. Whatever the reason IEEE 1588 2008 includes support for unicast operation.

When one or more masters have been identified the slave can use Unicast Negotiation to get Announce and Sync messages sent from the master, and to get Delay Requests answered with Delay Responses.

The PTP message sequences between the master and a slave are repeated until the duration of a negotiated interval expires. For example a slave might ask for 4 Sync messages per second, for a period of 60 seconds. In this case after 60 seconds the master would stop sending Sync messages until another Sync message contract was negotiated.

If unicast mode is selected then an additional sub menu will appear to configure or display unicast specific parameters.

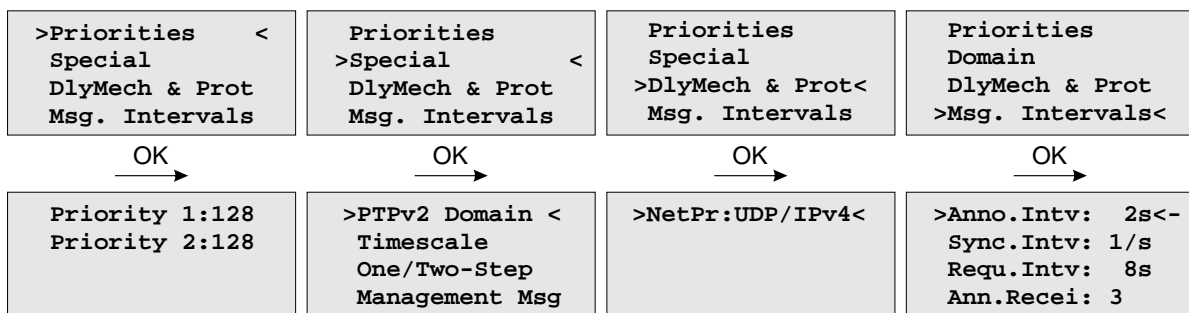

The following settings can be done in Unicast Master Mode:

- Priority1:** The attribute is used in the execution of the best master clock algorithm (BMCA). Lower values take precedence.

Configurable range: 0..255.

The operation of the BMCA selects clocks from a set with a lower value of priority1 over clocks from a set with a greater value of priority1.
- Priority2:** The attribute is used in the execution of the BMCA. Lower values take precedence.

Configurable range: 0..255.

In the event that the operation of the BMCA fails to order the clocks based on the values of priority1, clockClass, clockAccuracy, and scaledOffsetLogVariance, the priority2 attribute allows the creation of up to 256 priorities to be evaluated before the tiebreaker. The tiebreaker is based on the clockIdentity. The values clockClass, clockAccuracy, and scaledOffsetLogVariance depend on the internal state of the grandmaster and cannot be configured.
- PTPv2 Domain:** A PTP domain is a logical group of PTP devices within a physical network that belong to the same domain number. Slave devices that shall sync to a certain master within a network must have configured a unique domain number which is the same on the master.
- Timescale:** two options possible:

 - PTP:** In normal operation, the epoch is the PTP epoch and the timescale is continuous. The unit of measure of time is the SI second. The PTP epoch is 1 January 1970 00:00:00 TAI time source.
 - ARB as arbitrary:** In normal operation, the epoch is set by an administrative procedure.

One / Two Step: Two Step approach: The PTP protocol requires the master to periodically send SYNC messages to the slave devices. The hardware time stamping approach of PTP requires that the master records the exact time when such a SYNC packet is going on the network wire and needs to communicate this time stamp to the slaves. This can be achieved by sending this time stamp in a separate packet (a so-called FOLLOW-UP message).

One Step approach: the SYNC message itself is time stamped on-the-fly just before it leaves the network port. Therefore, not FOLLOW-UP message is needed.

Per default Two Step approach is enabled.

Management Msg: A protocol within PTP used to query and update the PTP data sets maintained by master clocks. These messages are also used to customize a PTP system and for initialization and fault management. Management messages are used between management nodes and clocks.

Per default are enabled.

DelayMech: in unicast mode only one option possible:
E2E (End-to-end) where delay measurement messages are sent from the slave to the master (the two end nodes).

NetPr: in unicast mode only one option for the network protocol possible:
UDP-UDP / IPv4 / IPv6 (Layer 3): User Data Protocol is one of the main protocols used for the Internet.

Msg. Intervals: specify the settings for the PTP timing messages.
Anno. Intv specifies the time for sending announce messages between masters to select the Grand Master. Available settings are: 16/s, 8/s, 4/s ... 2s, 4s, 8s, 16s with a default value 2 seconds.

Sync. Intv specifies the time for sending sync messages from a master to a slave. Available settings are: 128/s, 64/s ... 64s, 128s, with a default value 1 second.

Requ. Intv specifies an interval how often delay request messages are sent from a slave to the master. Delay request messages intervals 128/s, 64/s,... 64s, 128s, with a default value 2 seconds.

Ann. Recei value specifies the time for announce receipt timeout messages which is 2-10 times the Announce interval, with a default of 3. This is the time for a BMCA to determine a Grand master.

9.2.4.13 Multicast Slave (MRS only)

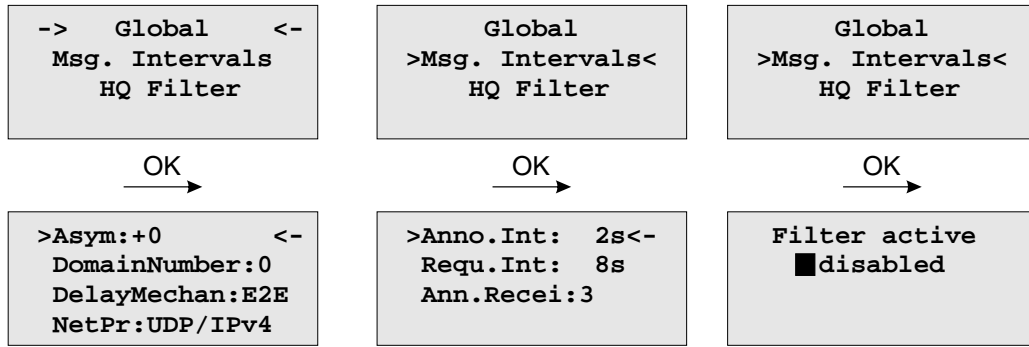

The following settings can be done in Multicast Slave Mode:

- Asym:** or Default Asymmetry is an initial calibration value (in ns) and can be entered here if a certain asymmetry offset in the network path is known before the PTP unit starts. This occurs in SDH networks for example.
- Max.Path Delay:** If a measured path delay exceeds the value of this parameter (in ns), then the PTP unit is able to detect a change in the asymmetry offset and can take this into account for its delay measurements.
- Note:** Keep defaults settings here (0 ns for both parameters) unless some problems with the client synchronization accuracy are observed and only if the asymmetry offset can be measured beforehand.
- PTPv2 Domain:** A PTP domain is a logical group of PTP devices within a physical network that belong to the same domain number. Slave devices that shall sync to a certain master within a network must have configured a unique domain number which is the same on the master.
- DelayMech:** two options possible:
 E2E (End-to-end) where delay measurement messages are sent from the slave to the master (the two end nodes).
 P2P (Peer-to-peer): where each device (a peer) in the network exchanges peer-delay measurement messages. This way each device can keep track of the delays between itself and its immediately connected neighbors (for example a switch or a router). P2P mechanism can be used in 1588 PTP capable networks only.
- NetPr:** two options for the network protocol possible:
 ETH-IEEE 802.3 / Ethernet (Layer 2): Ethernet frame including MAC addresses of a destination and a source.
 UDP-UDP/IPv4/IPv6 (Layer 3): User Data Protocol one of the main protocols used for the Internet.

- Msg. Intervals:** specify the settings for the PTP timing messages.
- Anno. Intv** specifies the time for sending announce messages between masters to select the Grand Master. Available settings are: 16/s, 8/s, 4/s ... 2s, 4s, 8s, 16s with a default value 2 seconds.
- Sync. Intv** specifies the time for sending sync messages from a master to a slave. Available settings are: 128/s, 64/s ... 64s, 128s, with a default value 1 second.
- Requ. Intv** specifies an interval how often delay request messages are sent from a slave to the master. Delay request messages intervals 128/s, 64/s,... 64s, 128s, with a default value 2 seconds.
- Ann. Recei** value specifies the time for announce receipt timeout messages which is 2-10 times the Announce interval, with a default of 3. This is the time for a BMCA to determine a Grand master.
- HQ Filter:** In heavy loaded networks when using non-PTP compliant switches, the "HQ Filter" can be activated to reduce the jitter. Detailed information about the usage and the configuration of the HQ filter can be found in the "PTPv2 Configuration Guide" in chapter [PTP Option](#). The Default setting is with HQ Filter disabled.

9.2.4.14 Unicast Slave (MRS only)

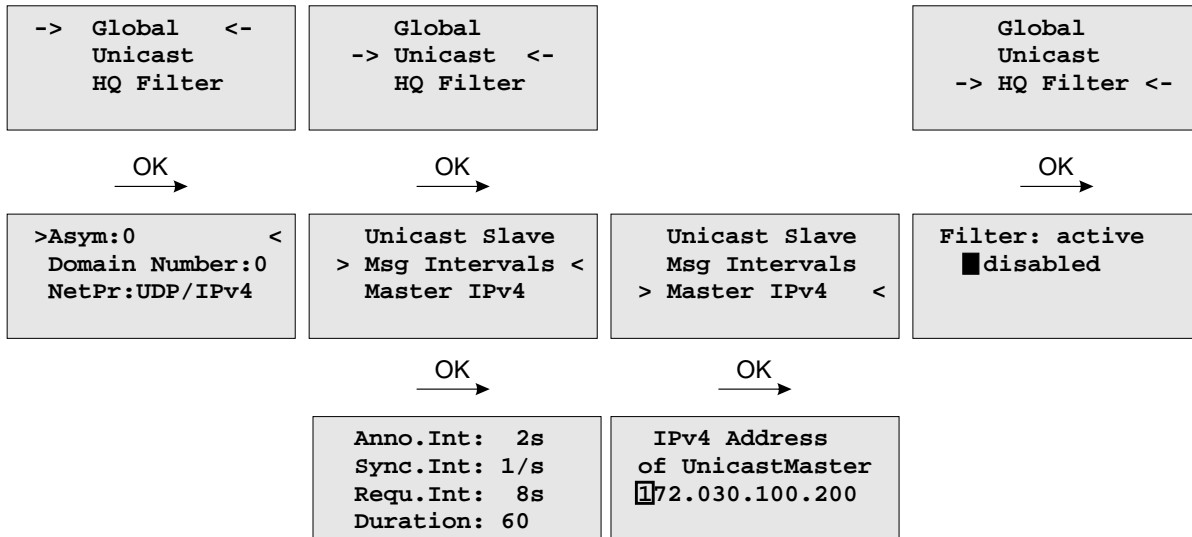

The following settings can be done in Unicast Slave Mode:

- Asym:** or Default Asymmetry is an initial calibration value (in ns) and can be entered here if a certain asymmetry offset in the network path is known before the PTP unit starts. This occurs in SDH networks for example.
- Max. Path Delay:** If a measured path delay exceeds the value of this parameter (in ns), then the PTP unit is able to detect a change in the asymmetry offset and can take this into account for its delay measurements.
- Note:** Keep defaults settings here (0 ns for both parameters) unless some problems with the client synchronization accuracy are observed and only if the asymmetry offset can be measured beforehand.
- PTPv2 Domain:** A PTP domain is a logical group of PTP devices within a physical network that belong to the same domain number. Slave devices that shall sync to a certain master within a network must have configured a unique domain number which is the same on the master.
- NetPr:** one setting possible:
UDP-UDP/IPv4 (Layer 3): User Data Protocol one of the main protocols used for the Internet.
- Msg Intervals:** specify the settings for the PTP timing messages.
 - Anno. Intv** specifies the time interval of announce messages between master servers to select the Grand Master. Note: This value should be the same as for the master. Available settings are: 1, 2, 4, 8 or 16 seconds, with a default value of 2 seconds.
 - Sync. Intv** specifies the time interval of sync messages that a slave requests from a master. Available settings are 0.5, 1, or 2 seconds, with a default value of 1 second.
 - Requ. Intv** specifies an interval how often delay request messages are sent from a slave to the master. Delay request messages intervals of 1, 2, 4, 8, 16 or 32 seconds, with a default value of 8 seconds.

The **Duration** parameter is used to set a timeout for the grandmaster that sends out the sync packages until the timeout expires. A slave sends a new signaling message to refresh the request before the end of the Duration timeout. Thus it is receiving the requested sync packages continuously. The duration parameter will handle all message types and should be in the range between 10-300 s.

- Master IPv4:** The correct IP address of the Master's PTP port must be entered in this field.
- HQ Filter:** In heavy loaded networks when using non-PTP compliant switches, the "HQ Filter" can be activated to reduce the jitter. Detailed information about the usage and the configuration of the HQ filter can be found in the "PTPv2 Configuration Guide" in chapter [PTP Option](#). The Default setting is with HQ Filter disabled.

9.2.4.16 Optional Menu: 2nd Receiver

With the submenu *2ndreceiver* you can select the Fallback mode (Redundant or SHS) and you also can adjust the time limits for the "Warning level" and the "Critical Level" here.

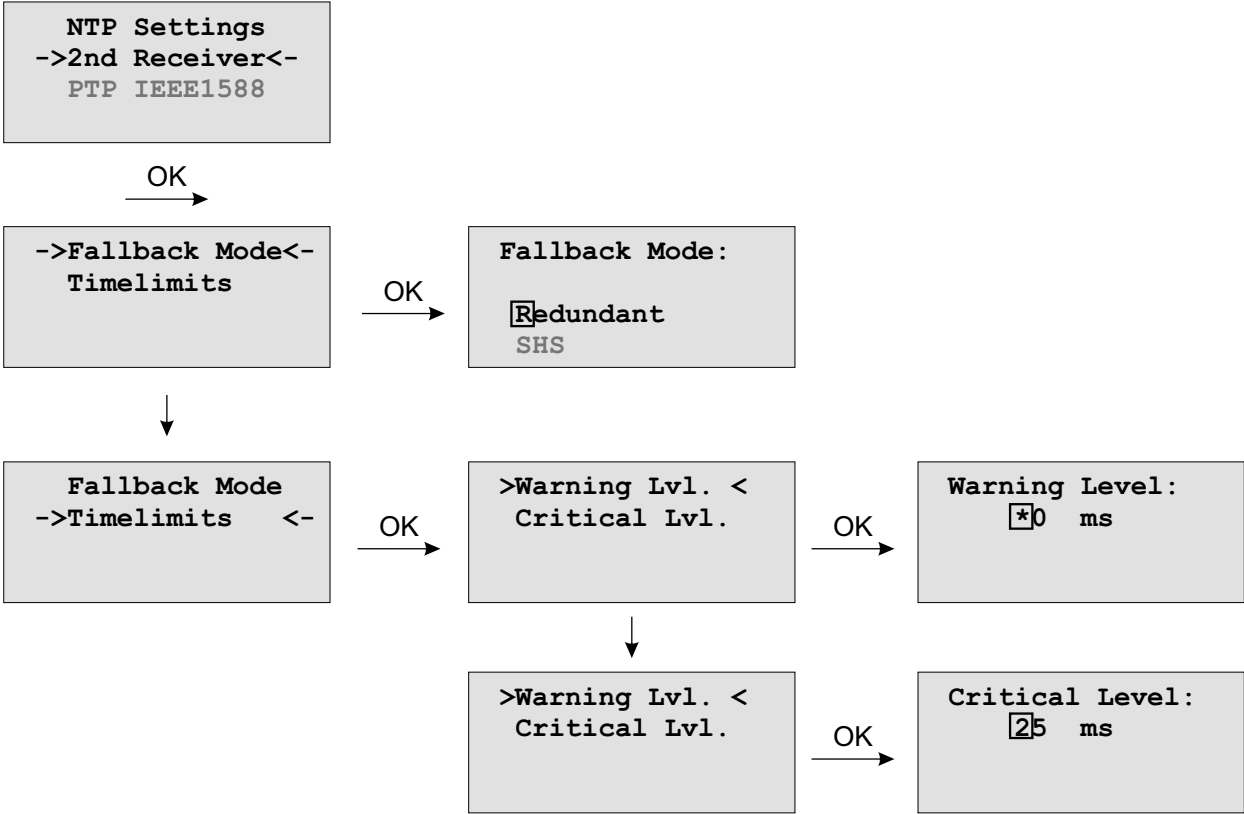

9.2.5 Menu: Network

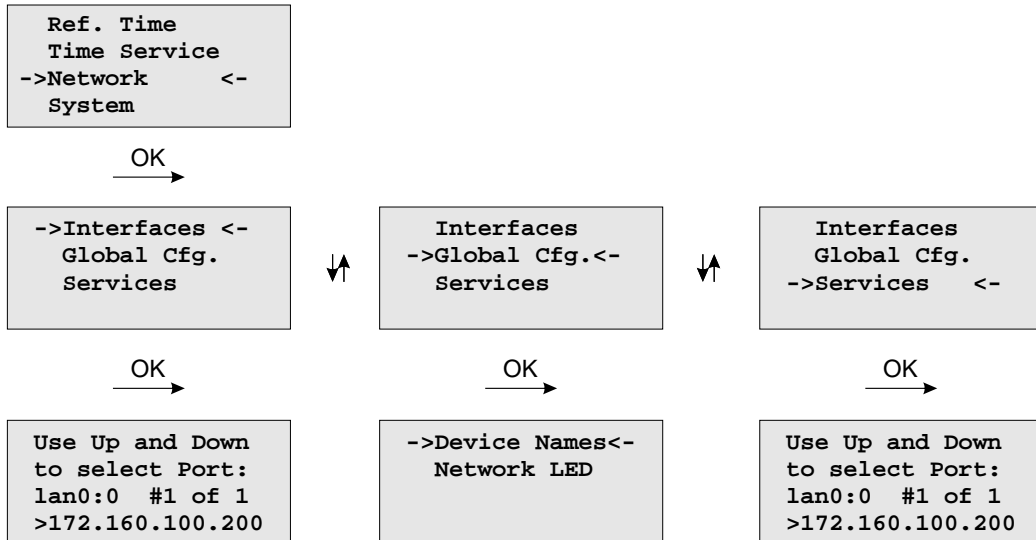

In this submenu the network configuration parameters related to the network interfaces can be changed. The submenus can be selected with the arrow keys and the “OK” button:

As soon as an IP address is configured, additional network configuration can be done via network connection with TELNET, SSH or the WEB interface. Ask your network administrator for network specific parameters. Every change of the network parameters will restart the NTP. All network specific parameters will be saved on the flash disk (/mnt/flash/config/global_configuration) and will be reloaded after reboot. It is highly recommended not to edit this file manually but to configure the parameters via the several configuration interfaces (HTTP, CLI or SNMP). If this file is not present, an empty file will be created. See Appendix for the default settings of this file.

9.2.5.1 Menu: Setup Network Interfaces

In the network configuration parameters related to the network interfaces can be changed. The following submenus can be selected with the arrow keys and the “OK” button:

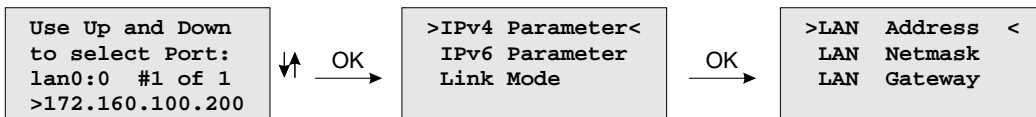

When configured an IP address once additionally network configuration can be done via network connection with TELNET, SSH or the WEB interface. Ask your network administrator for network specific parameters. Every change of the network parameters will restart the NTP. All network specific parameters will be saved on the flash disk (/mnt/flash/config/global_configuration) and will be reloaded after reboot.

9.2.5.2 Menu: Setup IPv4 LAN Parameter

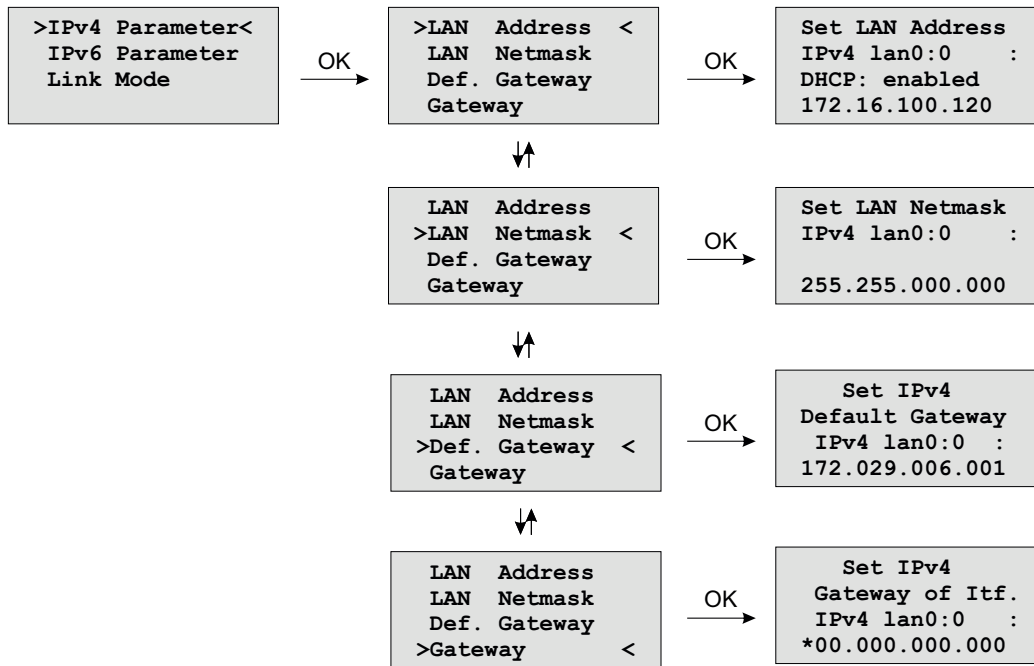

There is a separate configuration submenu for every physical network interface. If there is no DHCP client mode activated a static IP address for each interface can be entered. IPv4 addresses are built of 32 bits which are grouped in four octets, each containing 8 bits. You can specify an IP address in this mask by entering four decimal numbers, separated by a point "." .

Example: 172.160.100.200

Additionally you can specify the IPv4 netmask and your default gateway address.

Please contact your network administrator, who can provide you with the settings suitable for your specific network.

If there is a DHCP (Dynamic Host Configuration Protocol) server available in your network, the LANTIME system can obtain its IPv4 settings automatically from this server. If you want to use this feature (again, you should ask your network administrator whether this is applicable in your network), you can change the DHCP Client parameter to "enabled". Using DHCP is the default factory setting.

If the DHCP client has been activated, the automatically obtained parameters are shown in the appropriate fields (IPv4 Address, Netmask, Default Gateway).

9.2.5.3 Menu: Setup IPv6 Parameter

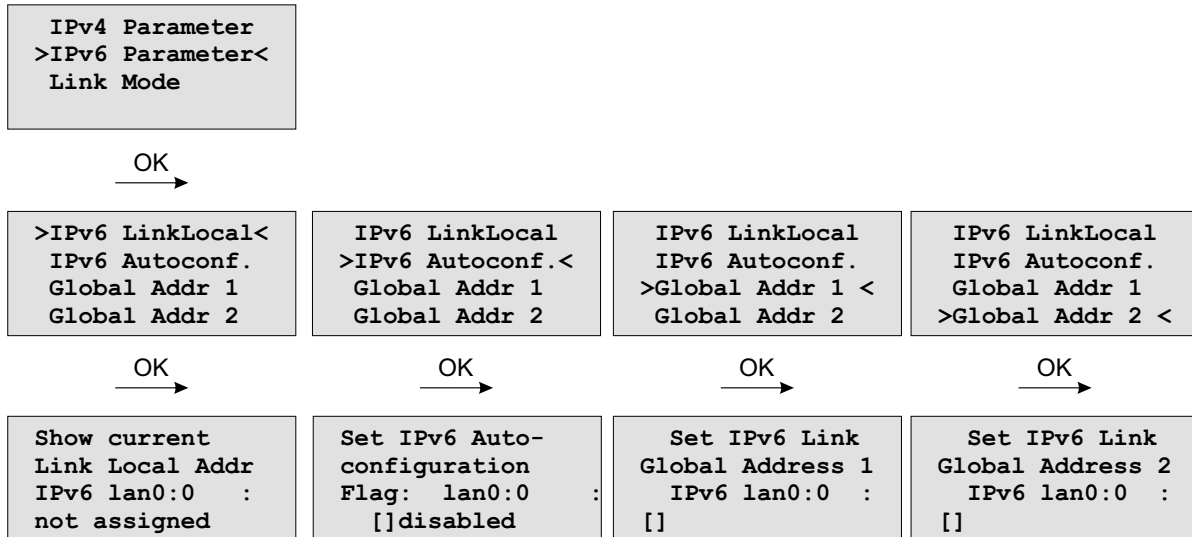

The IPV6 parameter can be configured via the front panel display for the first ethernet port (ETH0) only. Additionally IPV6 configuration can be done via network connection with TELNET, SSH or the WEB interface.

You can specify up to three IPv6 addresses for your LANTIME timeserver. Additionally you can switch off the IPv6 autoconf feature. IPv6 addresses are 128 bits in length and written as a chain of 16 bit numbers in hexadecimal notation, separated with colons. A sequence of zeros can be substituted with “::” once.

If you enabled the IPv6 protocol, the LANTIME always gets a link local address in the format “fe80:: ...”, which is based upon the MAC address of the interface. If a IPv6 router advertiser is available in your network and if you enabled the IPv6 autoconf feature, your LANTIME will be set up with up to three link global addresses automatically.

9.2.5.4 Menu: Link Mode

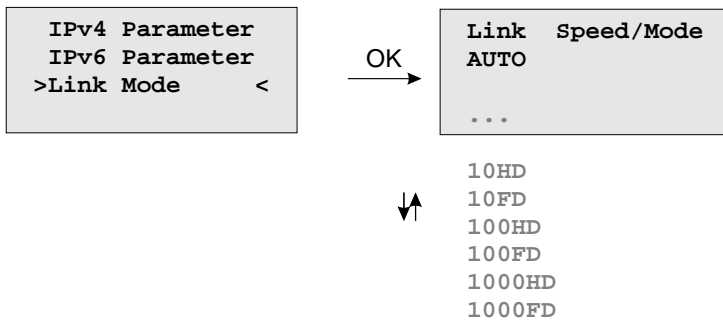

With the Link Mode submenu the parameters for link speed and duplex mode of the first ethernet interface (ETH0) can be configured. There are 5 modes available: Autosensing, 10 Mbit/Half Duplex, 100 Mbit/Half-Duplex, 1000 Mbit/Half-Duplex (Gigabit Support), 10MBit/Full-Duplex, 100 Mbit/Full-Duplex and 1000 Mbit/Full-Duplex (Gigabit Support).

The interfaces are configured with „Autosensing“ by default.

9.2.5.5 Menu: Global Configuration

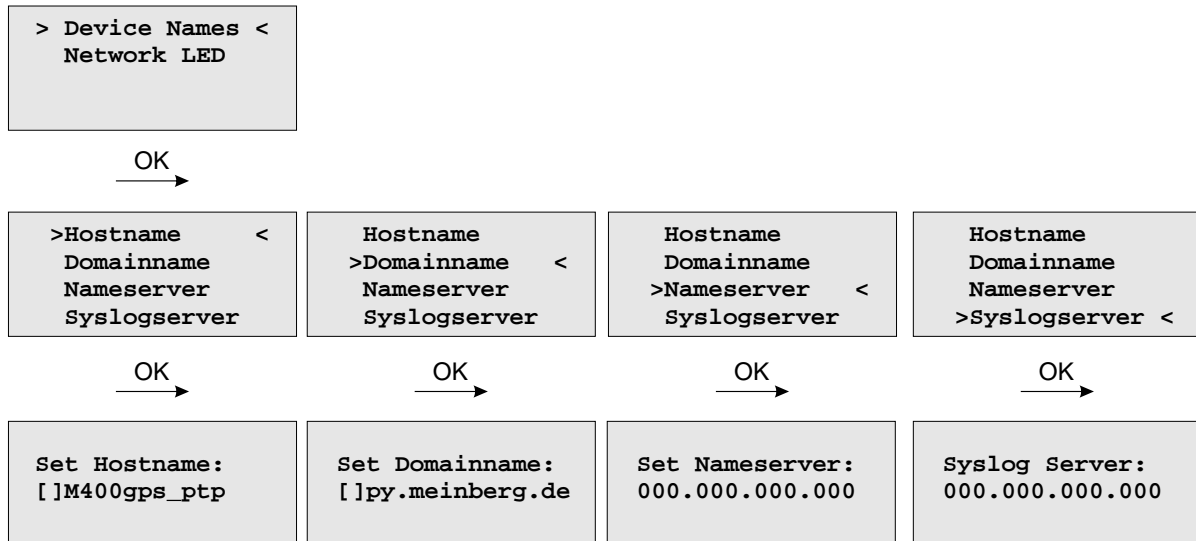

In this sub menu you can change the global network settings like host and domain name, nameserver and syslog server. Further name- or syslog servers can be set up via HTTP interface or CLI Setup. In the nameserver and syslog server fields you have to enter an IPv4 address.

All information written to the LANTIME SYSLOG (/var/log/messages) can be forwarded to one or two remote SYSLOG servers. The SYSLOG daemon of this remote SYSLOG needs to be configured to allow remote systems to create entries. A Linux SYSLOG daemon can be told to do so by using the command “syslogd -r” when starting the daemon.

If you enter nothing in the SYSLOG server fields or specify 0 .0.0.0 as the SYSLOG servers addresses, the remote SYSLOG service is not used on your LANTIME.

Please be aware of the fact that all SYSLOG entries of the timeserver are stored in „/var/log/messages“ and will be deleted when you power off or reboot the timeserver. A daily CRON job is checking for the size of the LANTIME SYSLOG and deletes it automatically if the log size is exceeding a certain limit.

By specifying one or two remote SYSLOG servers, you can preserve the SYSLOG information even when you need to reboot or switch off the LANTIME.

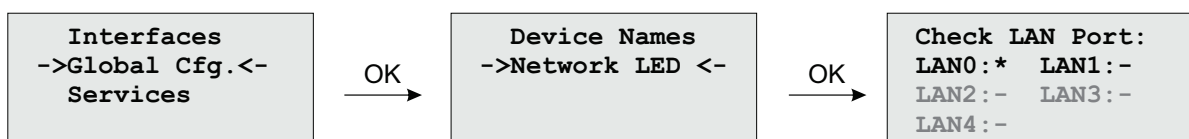

The submenu „Netw. LED“ will monitor the network ports, which will be checked continuously if the network port is „LINKED UP“. If one of these ports has no link up, the network LED on the front panel will change to red. An „L“ for „LED“ indicates if the port is checked. Please navigate through the list of ports with the LEFT/RIGHT buttons and change the setting with the UP/DOWN buttons.

9.2.5.6 Menu: Network Services

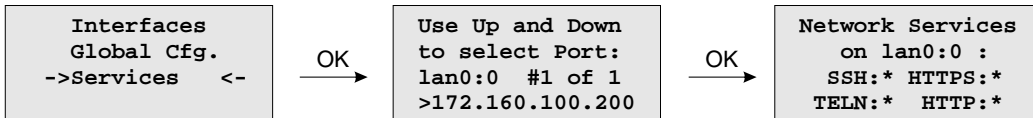

The possible network protocols and access methods can be configured. After pressing the OK button you can enable/disable SSH, TELNET, SNMP, FTP, IPV6, HTTP, HTTPS and NETBIOS by using the UP/DOWN Keys and navigate through the list with the LEFT/RIGHT keys. After you saved your settings with the "OK" button, all these subsystems are stopped and eventually restarted (only if they are enabled, of course).

9.2.6 Menu: System

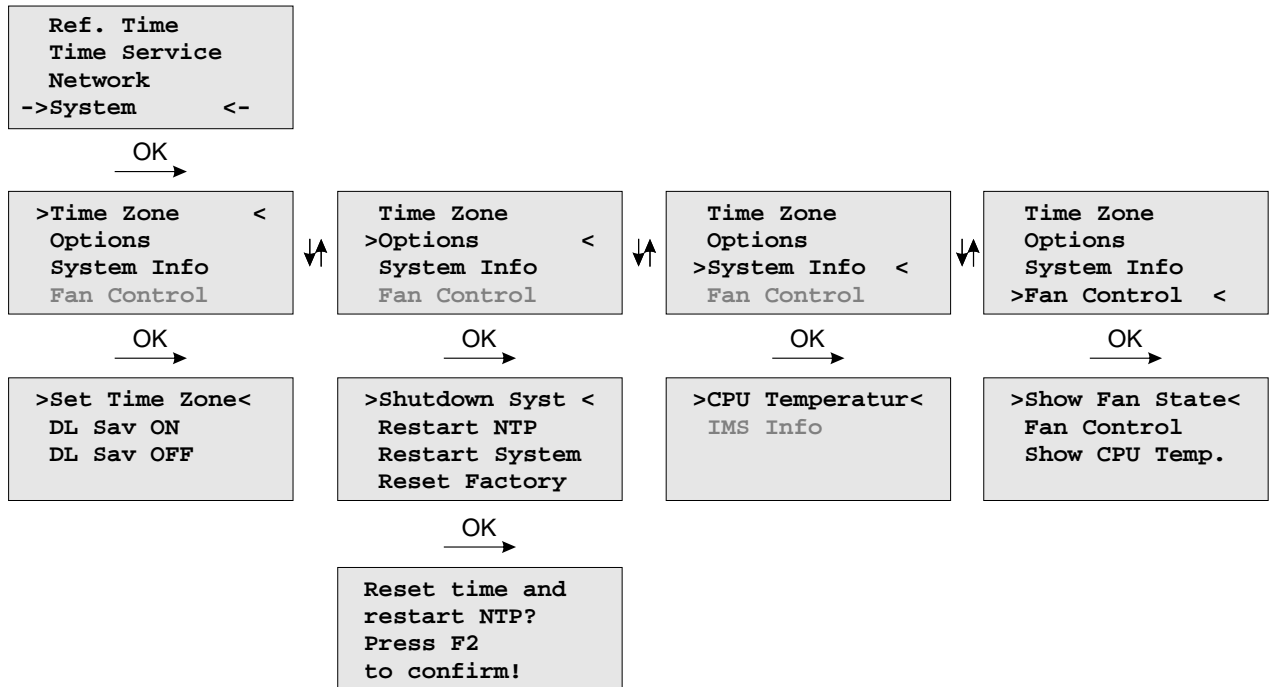

In this submenu system specific parameters can be configured.

9.2.6.1 Menu: Set Time Zone of Display

The time zone of the time that is shown on the front panel display can be set up here. The internal time zone of the timeserver and the time of NTP will always be UTC. These parameters will not affect the serial output lines and the timecode (IRIG) outputs. These parameters have to be configured in another menu - (Reference Time->Setup Outputs).

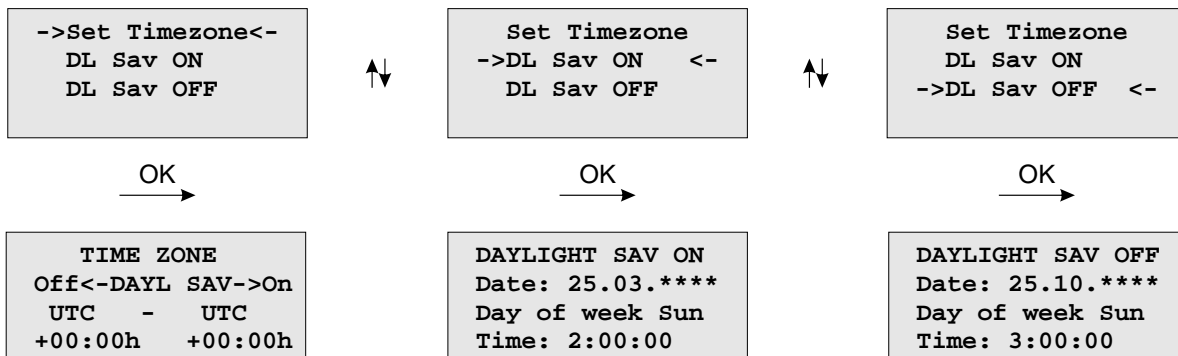

This menu lets the user enter the names of the local time zone with daylight saving disabled and enabled, together with the zones' time offsets from UTC. These parameters are used to convert UTC to local time, e.g. MEZ = UTC + 1h and MESZ = UTC + 2h for central Europe. The range of date daylight saving comes in effect can be entered using the next two pages of the setup menu.

Beginning and ending of daylight saving may either be defined by exact dates for a single year or using an algorithm which allows the receiver to re-compute the effective dates year by year. The figures below show how to enter parameters in both cases. If the number of the year is displayed as wildcards ('*'), a day-of-week must be specified. Then, starting from the configured date, daylight saving changes the first day which matches the configured day-of-week. In the figure below October 25th, 2008 is a Saturday, so the next Sunday is October 26th, 2008.

All changeover rules for the daylight saving like "the first/the second/the second to last/the last Sunday/Monday etc. in the x-th month," can be described by the used format "first specified day-of-week after a defined date".

If the number of the year is not displayed as wildcards the complete date exactly determines the day daylight saving has to change (October 26th, 2008 in the figures below), so the day-of-week does not need to be specified and therefore is displayed as wildcards.

If no changeover in daylight saving is wanted, identical dates and times must be entered in both of the submenus (DAYLIGHT SAV ON/OFF).

9.2.6.2 Menu Options

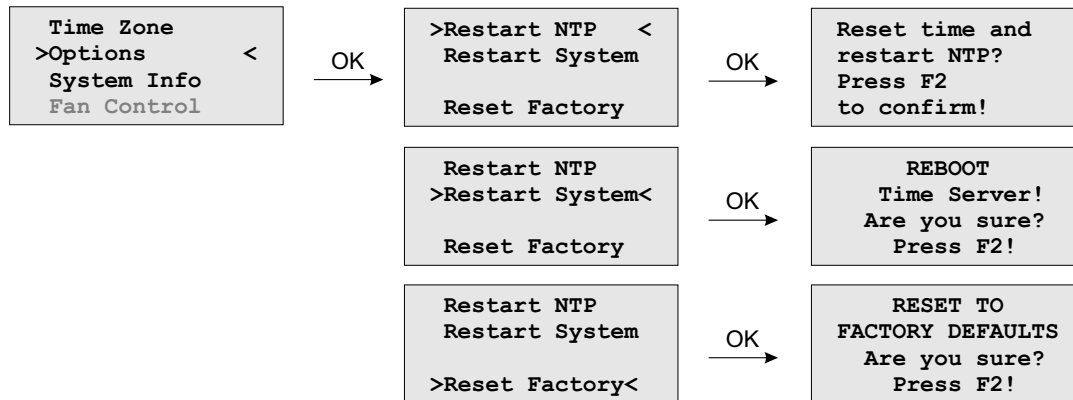

In menu option you can make the following settings or request setting information:

- Time Zone:** The converted time (offset to UTC) for the configured time zone, which is shown in the display. This has no effect on the time strings that are outputted via the serial interfaces.
- You can make this setting via the menu "Ref. Time -> Set Outputs -> Time Zone".
- Options:** In this sub menu you can reset the system to the state of delivery by using "Reset Factory". The network settings remain unchanged.
- With "Restart NTP" you can restart the NTP service and with "Restart System" the LINUX operating system of the CPU.
- System Info:** With "System Info" you can request the current operating temperature of the CPU. If the LANTIME is used in an IMS System, information about the system configuration, like the allocation of single slots, can be displayed in this menu section.
- Fan Control:** If an active cooling is installed, the cooling status can be displayed via this menu item and via "Fan Control" you can set the mode of the active cooling:
- Auto:** (temperature independent - the threshold value can be adjusted via the webinterface - menu "System -> Fan Control".
- FAN ON:** The cooling is permanently active.
- FAN OFF:** The cooling is permanently off.

9.2.6.3 Shutdown System

Before the system is switched off by a mains switch, make sure that processes are not interrupted that have to be completed before the device is switched off. For example, if the SyncMonitor is stopped abruptly when saving data to the internal flash, this data will be lost.

```

>Shutdown Syst <
Restart NTP
Restart System
Reset Factory
  
```

The "Shutdown" stops the LANTIME daemon and the SyncMonitor and prepares the system for shutdown.

9.2.6.4 Menu: Restart System

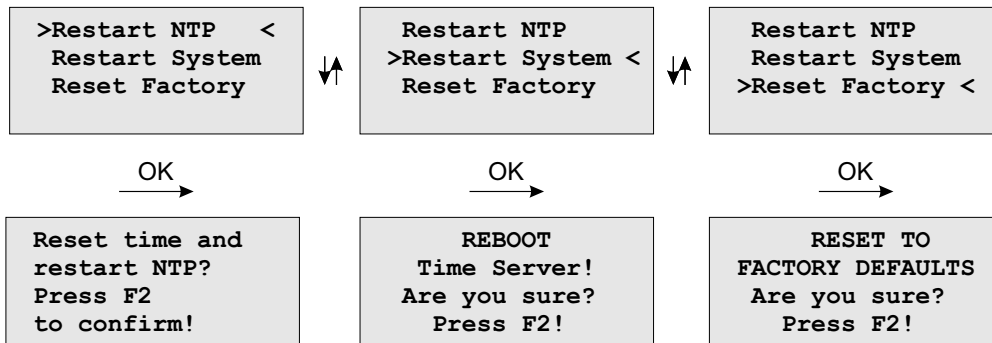

If the time of the reference clock has changed (e.g. while testing with different times) the system time has to be set with the time of the reference clock and the NTP has to be restarted.

The command **Reboot System** reboots the Linux operating system – the built-in reference clock will not be restarted.

9.2.6.5 Menu Factory Reset

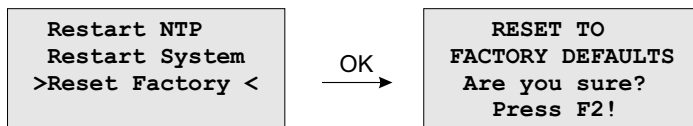

When **Reset to factory defaults** is called and confirmed, all network parameters and system parameters are reset to factory settings.

9.2.6.6 Menu System Info

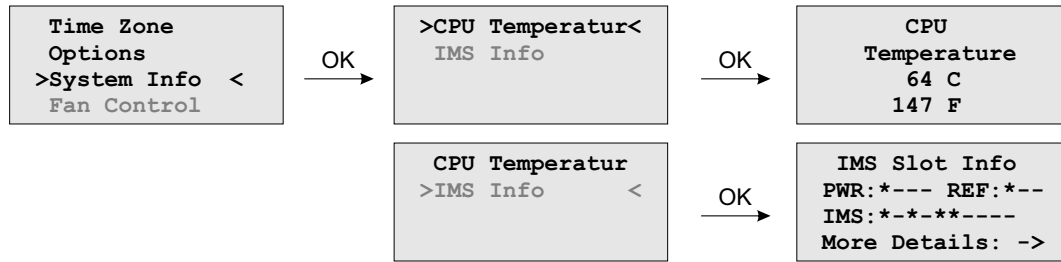

In the "System Info" submenu, the CPU temperature can be queried. In IMS systems a detailed overview of the system configuration can be shown.

9.2.6.7 Option: Menu IMS Slot Info

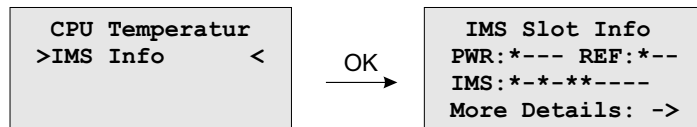

Note: This display menu is visible only in case of an IMS system. Here a detailed overview of the modules, used in the selected slots, are given.

The example above shows the configuration of a LANTIME M3000:

PWR:*— This string means PWR 1 is occupied and active.

REF:*— CLK 1 is occupied, CLK 2 and RSC (SCU slot) are empty.

IMS:*-*-*— Indicates that the IMS slots MRI 1, ESI 1 and IO 1 and IO2 are occupied and active.

More Details: ->With the OK button you can open the submenu "Select Slot"

9.2.6.8 Option: IMS Menu Select Slots

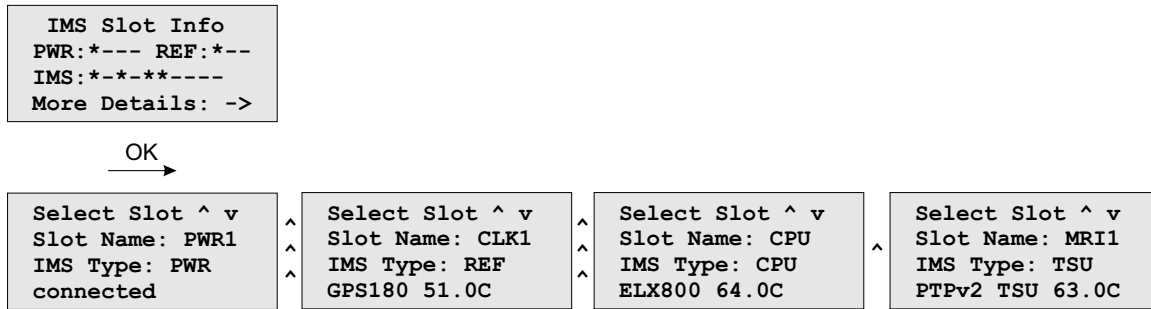

This menu shows which module is inserted into the selected slot.

Displayed values are:

Slot Name: In this example, PWR 1, CLK1, CPU, MRI1, IO1 and IO2

IMS Type: PWR (power supply), REF (receiver), CPU (processor unit), LIU (Telecom outputs) ...

On the bottom line, the current operating temperature (degrees/celsius) is displayed.

9.2.6.9 Option: Fan Control

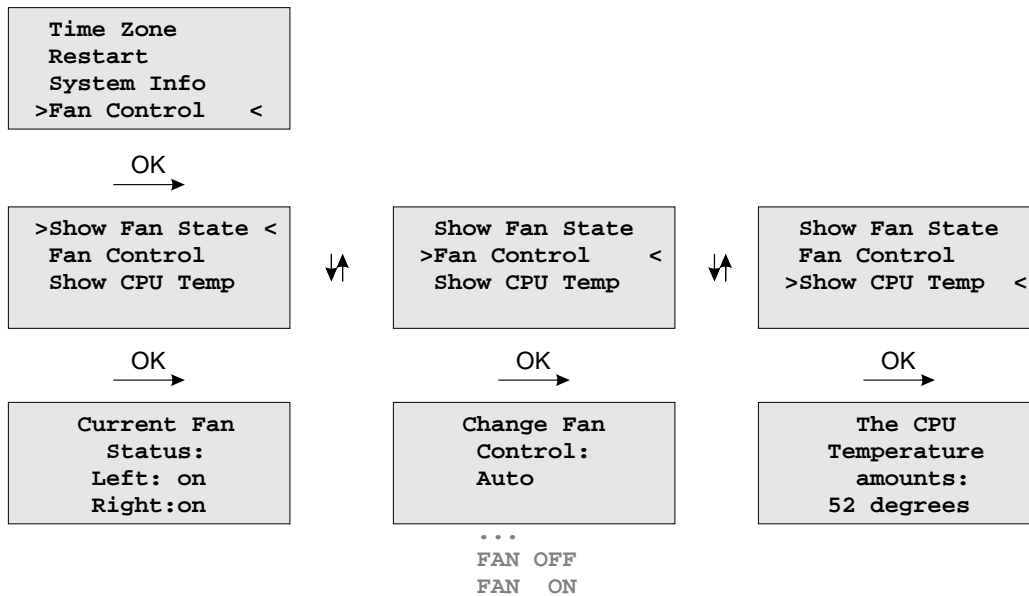

With the optional fan control menu the current status of the operational temperature and the fans can be displayed on the systems interface. The mode of the fans can be selected here:

- FAN ON** the ventilators are always running
- FAN OFF** the ventilators are off
- Auto** the ventilation runs from the temperature, which is specified by the "Temperature Threshold" parameter (see "The Web Interface").
The default value is +55 degrees celsius. If the temperature of the device is less than 7 degrees (Celsius) as the specified value, the fan control turns off automatically.

9.2.7 USB Stick Menu

LANTIME NTP servers provide an USB interface for connecting an USB storage device. The USB stick can be used in combination with the LANTIME or the LAN-CPU for various tasks:

- Transfer configuration parameters between different LANTIMEs
- Keypad locking for secure using the keypad of the LCD
- Transfer of log files
- Install Software Updates
- Upload and download secure certificates (SSL, SSH) and passwords



When connecting the USB stick the LC-Display will – after a few seconds – signal that the USB stick has been detected and allows you to enter the USB menu with the "OK" button.

```
USB Memory Stick
(OK to confirm)
```

The desired menu function can be chosen by using ↑ and ↓ keys and it will be activated with the "OK" button. You can leave this menu with removing the USB storage or with the "ESC" button.

Menu "Install Firmware"

If a firmware update file is stored on the USB stick, the menu item "Install [Firmware Version]" appears on the display. Now you can install the update package on the LANTIME by pressing the OK button. The file format is *firmware-6.24.020-x86.rel*. However, only the version is shown in the display, in this example *6.24.020-x86*.

```
USB Stick Menu
(OK to confirm)
Install
7.xx.xxx-x86
```

Note:

After uploading the new firmware to the LANTIME the new version has to be activated via the web interface (menu "System → Firmware/Software Update") or the CLI (Command Line Interface).

Menu "Save as Startup"

If this menu item is confirmed with the OK key, the firmware configuration of the LANTIME currently marked as "Start configuration" is saved on the USB stick.

**USB Stick Menu
(OK to confirm)
Save as Startup**

Please Note:

Even if you are currently making changes to a LANTIME, you can only save the configuration on the USB stick which you have confirmed via the web interface as "Startup configuration". This has the advantage that you can save your "old" configuration even if you make extensive changes to the settings of your system.

Menu "Backup Configuration to USB Stick"

With this submenu you can copy the configuration file from your LANTIME to the USB storage device. The stored configuration you can then find on your USB stick under */Lantime/Config/USB_Backup/xxxxxxxxxxx* (xxx... = the 12-digit serial number of your LANTIME).

Note:

The configuration copied to the USB stick is always the currently stored "Start-up configuration" of the system.

**USB Stick Menu
(OK to confirm)
Backup Config.
to USB Stick**

If the backup is to be imported on other LANTIMES, the directory must be renamed:
/Lantime/Config/USB_Backup/ANY_SN

Menu "Write Diagnostic File to USB Stick"

**USB Stick Menu
(OK to confirm)
Write Diag. File
to USB Stick**

This submenu is an easy way to get the contents of the LANTIMES diagnostic files. After you push the OK button, the system will copy a file archive to your USB device: */Lantime/Diag/ltdiag.tgz*

Keypad locking

The USB stick can be used for locking the function buttons of the LANTIME LC Display. Activating this feature the user cannot use the buttons without connecting the USB stick to the LANTIME. The access authorisation has been realized with a password file on the USB stick `/Lantime/keypad_lock`. This password file will be compared with `/mnt/flash/config/keypad_lock`. So it is possible to manage different LANTIME with one USB stick.

The keypad locking will be activated with a submenu from the USB stick:

```

USB Stick Menu
(OK to confirm)
  Lock
  Front Panel
    
```

When activating this submenu the file `/mnt/flash/config/keypad_lock` will be copied to the internal flash. When de-activating the keypad locking this file will be removed from the internal flash.

```

USB Stick Menu
(OK to confirm)
  Unlock
  Front Panel
    
```

Note:

Make sure, that you never loose the "Keypad_Lock" file or the USB storage device! If you have problems, please contact Meinberg Radio clocks: [Mail to techsupport@meinberg.de](mailto:techsupport@meinberg.de) .

Menu Restore Configuration

This command is for restoring the LANTIME configuration. The Timeserver restarts after this procedure.

1. A USB stick is required, on which a backup file is stored
2. The backup will only be imported, if a directory with the appropriate SN is available (or "ANY_SN")
3. After "Restore" the config is not bootable yet. To activate this, you must first execute the 'saveconfig' command via a CLI (console program) or use the web interface and press the "Save as Startup Configuration" button.

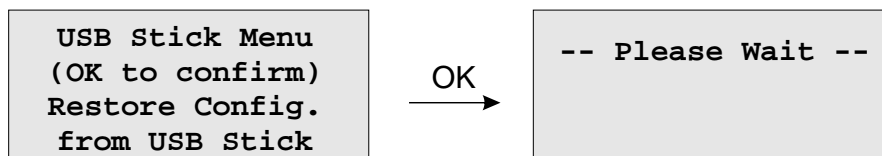

9.3 Via Serial Connection

Initial Start of Operation: LANTIME Configuration Wizard

After the boot-phase of the device, you have to establish a serial connection with the LAN-CPU. Via the terminal connection it is possible to configure parameters with a command line interface. Use a NULL-Modem cable or a CAB-CONSOLE-RJ45 cable to connect your PC or Laptop. You can use for example the standard Hyperterminal program, shipped with your Windows operating system. Configure your terminal program with 38400 Baud, 8 Databits, no parity and 1 Stopbit. The terminal emulation has to be set to VT100. After connecting the LANTIME the login message appears (press RETURN for initial connection):

After the connection is successfully established use your login credentials in the welcome screen to enter a console.

```
Welcome to Meinberg LANTIME
login: _
```

Default settings are:

Login: **root**

Password: **timeserver**

(It may be the case to press a RETURN button again).

After successful registration change the current path to `/wizard/`. Start now the LANTIME Basic Configuration Wizard with "startwizard".

The following Wizard Welcome screen is now displayed:

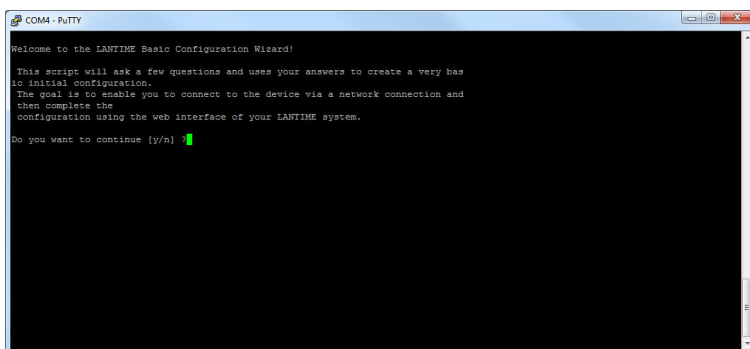

Confirm with "y" to start the configuration for all the following settings.

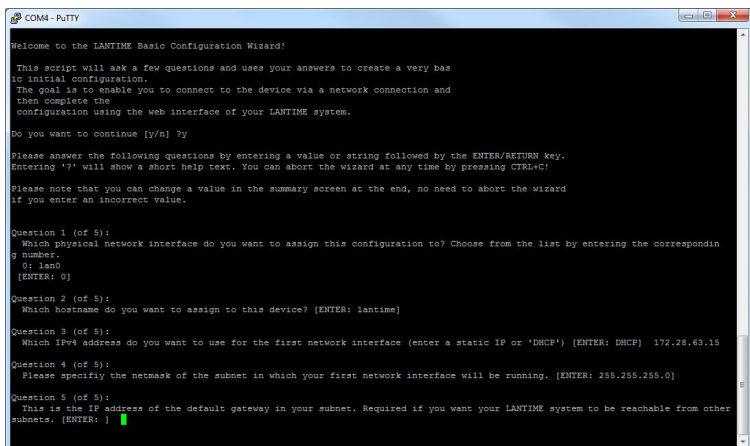

At the end please confirm your configuration.

After the lantime has been assigned to a correct IP address, all other settings can be done via the extensive and powerful web interface (see chapter [Via Web GUI](#)).

9.4 Via SNMP

9.4.1 The Simple Network Management Protocol

Most network connected devices support a number of management options including the Simple Network Management Protocol, or SNMP. SNMP is a network protocol which allows a single network management system to monitor a large number of devices on the network.

The way it works is each network element has an Agent which communicates with the Manager via SNMP. Each Agent has a corresponding Management Information Base, or MIB. The MIBs organize data elements in a tree structure. It is written in a standard, highly structured language so that the MIBs from all of the devices on the network can be compiled into the same Manager.

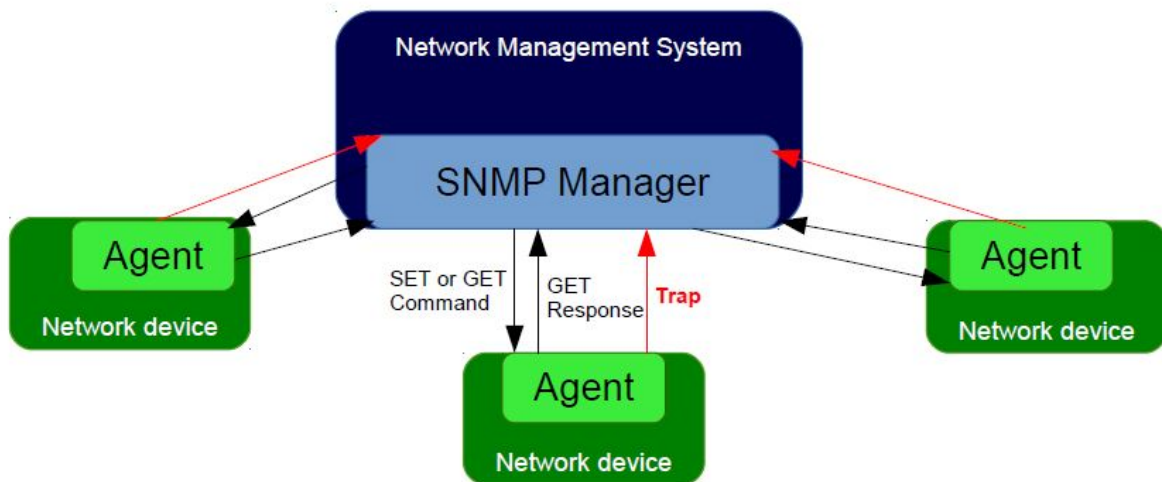

MIB elements are called Object Identifiers or OIDs. They consist of configuration variables, status variables, tree structure labels and notifications. The OIDs can be read or changed using SNMP SET and GET commands. There are also recursive commands which allow the Manager to ask for all of the OIDs in a branch (subtree), or even the whole tree. This process is referred to as "walking the MIB". Event Notifications, commonly referred to as traps, are a special type of OID. A trap can be configured so that when the status of the device changes a message is immediately sent from the Agent to the Manager.

9.4.2 MIB Objects of a LANTIME

An LTOS operating systems running on Meinberg LANTIME servers supports all SNMP versions (v1,v2c and v3) with a full functionality. The LANTIME propriatery OIDs are structured into subtrees, which define a particular system component or a mode of operation. The main subtree with OIDs referring to the LANTIME status of different modes is called LantimeNGStatus, NG standing for New Generation of LANTIME features in the LANTIME firmware. The LantimeNGStatus consists of eight subtrees, where Refclock, NTP, PTP, SystemHardware, Cluster and Misc are the most important to monitor.

9.4.2.1 Refclock subtree

Here is a short list of OIDs from the NGStatus subtree with corresponding descriptions:

mbgLiNgRefclockState

This OID describes a current state of a LANTIME refclock (hardware clock module) referring to GNSS or any other time source signal in MRS (Multi Reference Source) model.

| Status | Description |
|--------|--|
| 0: | <p><u>refclock is not available:</u> See the possible troubleshooting:</p> <ol style="list-style-type: none"> 1. Refclock module cannot be accessed. 2. Check if it is damaged and replace it if necessary. |
| 1: | <p><u>synchronized:</u> The reflock of your system is correctly synchronized to the selected time source (GPS or MRS). In an MRS system, a refclock can be synchronized to a reference time source from the priority list. See an example in the next figure.</p> <p>The MRS system above synchronizes first to GPS, but if the GPS signal is unavailable, the refclock switches to the next time source from the priority list (PTP in our case). The switch happens only after a trust time of the unavailable time source (GPS signal) has run out. This is to prevent hopping from one time source to another in short time periods. If GPS becomes available again, the refclock switches back to GPS, without waiting for the PTP trust time in this case, since GPS itself a higher precision than PTP.</p> |
| 2: | <p><u>not synchronized:</u> Obviously the refclock is not synchronized to its time source. Here is the possible troubleshooting:</p> <ol style="list-style-type: none"> A) Check if the GPS antenna is connected and reference time received. More about how to mount and position Meinberg GPS antenna correctly learn here. B) If GPS is the current time source, check number of satellites in view. There should be at least four to provide sync information. C) Start "warm boot" to refresh current satellite position. This is useful especially if the physical position of your LANTIME has been displaced by more than 100 km from its previous location and therefore obsolete satellite data are still stored in the system. D) Start "cold boot" to update a satellite almanac. E) If nothing from above helps, the GPS clock module needs to be changed. |

It is recommended configuring your network management software to check this status regularly, if possible every 60 s.

mbgLtNgRefclockLeapSecondDate

This OID conveys information about the next Leap Second Date. If the upcoming Leap Second Date has not been announced yet, the OID holds information about the previous leap second event.

Here is short summary of the leap seconds. There are two different timescales we usually talk about in the sync environment: GPS, which stands for Global Positioning System time and UTC (Universal Time Co-ordinated), formerly known as GMT (Greenwich Mean Time). They differ from each other by number of leap seconds introduced since beginning of GPS time on 6-Jan-1980. In the moment of writing the UTC is 16 seconds behind the GPS time, which is due to the uneven rotation of the Earth.

```
Since the introduction of a new leap second influences the time in the whole system being synchronized, we suggest to check this status regularly, e.g. 1/hour.
```

Next in a row of OIDs are those referring to NTP status. They can be found in the “mbgLtNgNtp” subtree.

9.4.2.2 NTP subtree

Here is a short list of OIDs from the NGStatus subtree with corresponding descriptions:

mbgLiNgNtpCurrentState

This is one of the most important OID in this subtree to check regularly. It informs about the NTP service of your LANTIME. There are three states possible:

| Status | Description |
|--------|---|
| 0: | <p><u>not available:</u> See the possible troubleshooting:</p> <p>A) Check if NTP service is actually enabled at a given LAN interface. To check it, log in to a webinterface. Factory default credentials: root/timeserver. Go to menus: "Network → Network Services" and activate the service of the corresponding interface. See Figure 3 for details.</p> <p>B) Check if it is damaged and replace it if necessary.</p> |
| 1: | <p><u>not synchronized:</u> In case of "not synchronized" the NTP service is not yet synchronized to a reference clock. Possible causes for this state are as follows:</p> <p>A) NTP daemon is still in its initialization phase for which it needs approx. 3-5 min. Therefore wait a while and see if the status changes.</p> <p>B) If a refclock is not sync, the same is indicated in the NTP status. In such case NTP daemon is switched to synchronize to its local clock and its stratum value changes to 12. Please check the possible troubleshooting for a refclock status as described above.</p> |
| 2: | <p><u>synchronized:</u> The NTP service is in normal operation. The LANTIME is now working properly.</p> |

It is recommended to check NTP status regularly, but not more than every 64 s.

9.4.2.3 Hardware subtree

mbgLtNgSysPsStatus

If a LANTIME has a redundant power supply (RPS) unit, it is important to check the status of both RPS modules regularly. This PowerSupplyStatus OID can be found in the System Hardware subtree. The following states are available:

| Status | Description |
|--------|--|
| 0: | <u>notAvailable</u> : The queried power supply unit is not recognized by a system. Check to see if it is damaged, and replace it if necessary. |
| 1: | <u>down</u> : The power supply unit of interest is not in service. Check to see if it is damaged, and replace it if necessary. |
| 2: | <u>up</u> : The queried power supply module is in operation. |

It is recommended to check this OID every 60 s.

9.4.2.4 Misc subtree

mbgLtNgEthPortLinkState

In the mbgLtNgMisc subtree one can find an EthPortLinkState OID which identifies the status of each physical Ethernet port of a LANTIME. Available values:

| Status | Description |
|--------|--|
| 0: | <u>notAvailable</u> : The queried port is down, check the link LED. If faulty, replace the network card. |
| 1: | <u>up</u> : The port of interest is in normal operation. |

It is recommended to check this OID every 60 s.

9.4.2.5 PTP subtree

If your LANTIME has IEEE 1588 PTPv2 functionality, the corresponding PTP OIDs can be found in the “mbgLtNgPtp” subtree. These are the most important OIDs to monitor:

mbgLiNgPtpPortState

The following PTP Port States are possible:

| Status | Description |
|--------|---|
| 0: | <u>uninitialized</u> : The port is booting up, the software daemon has not yet started, the IP address is not yet assigned. |
| 1: | <u>initializing</u> : In this state the port initializes its data sets, hardware, and communication facilities. |
| 2: | <u>faulty</u> : Not defined in a LANTIME. |
| 3: | <u>disabled</u> : PTP service has been disabled on this port, either by user configuration or because the module is in a standby mode. |
| 4: | <u>listening</u> : The port is waiting for the announceReceiptTimeout to expire or to receive an Announce message from a master. |
| 5: | <u>preMaster</u> : A short transitional state while the port is becoming a master. |
| 6: | <u>master</u> : The port is a current master. |
| 7: | <u>passive</u> : The port is in passive mode, meaning there is another master clock active in the PTP domain. The port can enter master state when it wins the BMCA due to a failure/service degradation of the current master. |
| 8: | <u>uncalibrated</u> : One or more master ports have been detected in the domain. |
| 9: | <u>slave</u> : The port has successfully subscribed to a master and receives all expected messages. It also successfully measured the path delay using delay request messages. |

It is recommended to monitor the PtpPortState OID every 3 s

9.4.3 SNMP Traps

| | |
|------------------------------|---|
| SNMP Trap Name: | mbgLtNgTrapNTPNotSync |
| OID: | .1.3.6.1.4.1.5597.30.3.0.1 |
| Severity: | Warning or critical |
| Short explanation: | the trap is sent when NTP is not synchronized |
| Reference to other chapters: | Troubleshooting and Alarming → NTP Messages → NTP Not Sync |
| Cleared By: | mbgLtNgTrapNTPSync |
| SNMP Trap Name: | mbgLtNgTrapNTPStopped |
| OID: | .1.3.6.1.4.1.5597.30.3.0.2 |
| Severity: | Critical |
| Short explanation: | trap to be sent when NTP is stopped |
| Reference to other chapters: | Troubleshooting and Alarming → NTP Messages → NTP Stopped |
| Cleared By: | MbgLtNgTrapNTPSync or mbgLtNgTrapNTPNotSync |
| SNMP Trap Name: | mbgLtNgTrapServerBoot |
| OID: | .1.3.6.1.4.1.5597.30.3.0.3 |
| Severity: | Info |
| Short explanation: | trap to be sent when time server has finished boot sequence |
| Reference to other chapters: | no further information |
| Cleared By: | - |
| SNMP Trap Name: | mbgLtNgTrapReceiverNotResponding |
| OID: | .1.3.6.1.4.1.5597.30.3.0.4 |
| Severity: | Critical |
| Short explanation: | trap to be sent when receiver is not responding |
| Reference to other chapters: | Troubleshooting and Alarming → Reference Clock → CLK Not Rspnding |
| Cleared By: | MbgLtNgTrapReceiverNotSync or mbgLtNgTrapReceiverSync |
| SNMP Trap Name: | mbgLtNgTrapReceiverNotSync |
| OID: | .1.3.6.1.4.1.5597.30.3.0.5 |
| Severity: | Error |
| Short explanation: | trap to be sent when receiver is not synchronised |
| Reference to other chapters: | Troubleshooting and Alarming → Reference Clock → CLK Not Sync |
| Cleared By: | mbgLtNgTrapReceiverSync |
| SNMP Trap Name: | mbgLtNgTrapAntennaFaulty |
| OID: | .1.3.6.1.4.1.5597.30.3.0.6 |
| Severity: | Critical |
| Short explanation: | trap to be sent when connection to antenna is broken |
| Reference to other chapters: | Troubleshooting and Alarming → Reference Clock → Antenna Faulty |
| Cleared By: | mbgLtNgTrapAntennaReconnect |
| SNMP Trap Name: | mbgLtNgTrapAntennaReconnect |
| OID: | .1.3.6.1.4.1.5597.30.3.0.7 |
| Severity: | Clearing event |
| Short explanation: | trap to be sent when antenna has been reconnected |
| Reference to other chapters: | no further information |
| Cleared By: | - |

| | |
|-------------------------------------|--|
| SNMP Trap Name: | mbgLtNgTrapConfigChanged |
| OID: | .1.3.6.1.4.1.5597.30.3.0.8 |
| Severity: | Info |
| Short explanation: | trap to be sent when timeserver reloaded its configuration |
| Reference to other chapters: | no further information |
| Cleared By: | - |

| | |
|-------------------------------------|---|
| SNMP Trap Name: | mbgLtNgTrapLeapSecondAnnounced |
| OID: | .1.3.6.1.4.1.5597.30.3.0.9 |
| Severity: | Info Warning |
| Short explanation: | trap to be sent when a leap second has been announced |
| Reference to other chapters: | Troubleshooting and Alarming → Ref. Clock → Leap Second Announced LTOS 6 Managm./Mon. → NTP → Leap Second Handling |
| Cleared By: | - |

| | |
|-------------------------------------|--|
| SNMP Trap Name: | mbgLtNgTrapSHSTimeLimitError |
| OID: | .1.3.6.1.4.1.5597.30.3.0.10 |
| Severity: | Critical |
| Short explanation: | trap to be sent when SHS timelimit exceeded |
| Reference to other chapters: | Troubleshooting and Alarming → Ref. Clock → SHS Time Limit Warning LTOS 6 Managm./Mon. → Web GUI → Introduction LTOS 6 Managm./Mon. → Web GUI → Security → SHS Mode LTOS 6 Managm./Mon. → Web GUI → Security → SHS Time Limit |
| Cleared By: | mbgLtNgTrapSHSTimeLimitOk |

| | |
|-------------------------------------|--|
| SNMP Trap Name: | mbgLtNgTrapSecondaryRecNotSync |
| OID: | .1.3.6.1.4.1.5597.30.3.0.11 |
| Severity: | Warning |
| Short explanation: | trap to be sent when secondary receiver is not synchronised |
| Reference to other chapters: | Troubleshooting and Alarming → Ref. Clock → CLK Not Sync |
| Cleared By: | mbgLtNgTrapSecondaryRecSync |

| | |
|-------------------------------------|---|
| SNMP Trap Name: | mbgLtNgTrapPowerSupplyFailure |
| OID: | .1.3.6.1.4.1.5597.30.3.0.12 |
| Severity: | Critical |
| Short explanation: | trap to be sent when one of the redundant power supplies fails |
| Reference to other chapters: | Important Safety Information → Security during Installation Important Safety Information → Safety during Operation |
| Cleared By: | mbgLtNgTrapPowerSupplyUp |

| | |
|-------------------------------------|---|
| SNMP Trap Name: | mbgLtNgTrapAntennaShortCircuit |
| OID: | .1.3.6.1.4.1.5597.30.3.0.13 |
| Severity: | Critical |
| Short explanation: | trap to be sent when a connected antenna fails due to a short circuit |
| Reference to other chapters: | Troubleshooting and Alarming → Ref. Clock → Antenna Short Circuit |
| Cleared By: | - |

| | |
|-------------------------------------|---|
| SNMP Trap Name: | mbgLtNgTrapReceiverSync |
| OID: | .1.3.6.1.4.1.5597.30.3.0.14 |
| Severity: | Clearing event |
| Short explanation: | trap to be sent when receiver is synchronised |
| Reference to other chapters: | Antenna and Receiver Information → Reference Time Sources |
| Cleared By: | - |

| | |
|------------------------------|--|
| SNMP Trap Name: | mbgLtNgTrapNTPClientAlarm |
| OID: | .1.3.6.1.4.1.5597.30.3.0.15 |
| Severity: | Error |
| Short explanation: | trap to be sent when an NTP Client Monitoring alarm occurs, e.g. when a monitored client is not reachable |
| Reference to other chapters: | check the network configuration in LTOS 6 Managm./Mon. → Network |
| Cleared By: | - |
| SNMP Trap Name: | mbgLtNgTrapPowerSupplyUp |
| OID: | .1.3.6.1.4.1.5597.30.3.0.16 |
| Severity: | Info |
| Short explanation: | trap to be sent when a power supply returned to a healthy state |
| Reference to other chapters: | no further information |
| Cleared By: | - |
| SNMP Trap Name: | mbgLtNgTrapNetworkDown |
| OID: | .1.3.6.1.4.1.5597.30.3.0.17 |
| Severity: | Critical |
| Short explanation: | trap to be sent when a monitored network port is down |
| Reference to other chapters: | Troubleshooting and Alarming → Network → Network Link Down |
| Cleared By: | mbgLtNgTrapNetworkUp |
| SNMP Trap Name: | mbgLtNgTrapNetworkUp |
| OID: | .1.3.6.1.4.1.5597.30.3.0.18 |
| Severity: | Clearing event |
| Short explanation: | trap to be sent when a monitored network port is up |
| Reference to other chapters: | no further information |
| Cleared By: | - |
| SNMP Trap Name: | mbgLtNgTrapSecondaryRecNotRespp |
| OID: | .1.3.6.1.4.1.5597.30.3.0.19 |
| Severity: | Warning or critical |
| Short explanation: | trap to be sent when secondary receiver is not responding |
| Reference to other chapters: | Troubleshooting and Alarming → Ref. Clock → CLK Not Responding |
| Cleared By: | mbgLtNgTrapSecondaryRecSync |
| SNMP Trap Name: | mbgLtNgTrapMrsLimitExceeded |
| OID: | .1.3.6.1.4.1.5597.30.3.0.30 |
| Severity: | Warning |
| Short explanation: | trap to be sent when a reference offset exceeds the configured limit |
| Reference to other chapters: | LTOS 6 Managm./Mon. → Web GUI → Clock → MRS Settings Troubleshooting and Alarming → Ref. Clock → MRS Limit Exceed |
| Cleared By: | - |
| SNMP Trap Name: | mbgLtNgTrapMrsRefDisconnect |
| OID: | .1.3.6.1.4.1.5597.30.3.0.31 |
| Severity: | Critical |
| Short explanation: | trap to be sent when a reference signal has been lost |
| Reference to other chapters: | Troubleshooting and Alarming → Ref. Clock → MRS Reference Disconnected |
| Cleared By: | mbgLtNgTrapMrsRefReconnect |

| | |
|-------------------------------------|---|
| SNMP Trap Name: | mbgLtNgTrapMrsRefReconnect |
| OID: | .1.3.6.1.4.1.5597.30.3.0.32 |
| Severity: | Clearing event |
| Short explanation: | trap to be sent when a reference signal recovered |
| Reference to other chapters: | no further information |
| Cleared By: | - |

| | |
|-------------------------------------|---|
| SNMP Trap Name: | mbgLtNgTrapFdmError |
| OID: | .1.3.6.1.4.1.5597.30.3.0.33 |
| Severity: | Critical |
| Short explanation: | trap to be sent when the Fdm module generates an alarm |
| Reference to other chapters: | LTOS 6 Managm./Mon. → Web GUI → FDM → FDM Configuration |
| Cleared By: | mbgLtNgTrapFDMOk |

| | |
|-------------------------------------|---|
| SNMP Trap Name: | mbgLtNgTrapSHSTimeLimitWarning |
| OID: | .1.3.6.1.4.1.5597.30.3.0.34 |
| Severity: | Warning Critical |
| Short explanation: | trap to be sent when SHS warning limit exceeded |
| Reference to other chapters: | LTOS 6 Managm./Mon. → Web GUI → Introduction LTOS 6 Managm./Mon. → Web GUI → Security → SHS Configuration LTOS 6 Managm./Mon. → Web GUI → Security → SHS Mode Troubleshooting and Alarming → Ref. Clock → SHS Time Limit Warning |
| Cleared By: | mbgLtNgTrapSHSTimeLimitOk |

| | |
|-------------------------------------|---|
| SNMP Trap Name: | mbgLtNgTrapSecondaryRecSync |
| OID: | .1.3.6.1.4.1.5597.30.3.0.35 |
| Severity: | Clearing event |
| Short explanation: | trap to be sent when secondary receiver is synchronised |
| Reference to other chapters: | Antenna and Receiver Information → Reference Time Sources |
| Cleared By: | - |

| | |
|-------------------------------------|--|
| SNMP Trap Name: | mbgLtNgTrapNTPSync |
| OID: | .1.3.6.1.4.1.5597.30.3.0.36 |
| Severity: | Clearing event |
| Short explanation: | trap to be sent when NTP is synchronised |
| Reference to other chapters: | no further information |
| Cleared By: | - |

| | |
|-------------------------------------|---|
| SNMP Trap Name: | mbgLtNgTrapPtpPortDisconnected |
| OID: | .1.3.6.1.4.1.5597.30.3.0.37 |
| Severity: | Warning or critical |
| Short explanation: | trap to be sent when PTP network port got disconnected |
| Reference to other chapters: | LTOS 6 Managm./Mon. → Web GUI → PTP → PTP Global Status |
| Cleared By: | mbgLtNgTrapPtpPortConnected |

| | |
|-------------------------------------|---|
| SNMP Trap Name: | mbgLtNgTrapPtpPortConnected |
| OID: | .1.3.6.1.4.1.5597.30.3.0.38 |
| Severity: | Clearing event |
| Short explanation: | trap to be sent when PTP network port got connected |
| Reference to other chapters: | no further Information |
| Cleared By: | - |

SNMP Trap Name: mbgLtNgTrapPtpStateChanged
OID: .1.3.6.1.4.1.5597.30.3.0.39
Severity: Info Warning
Short explanation: trap to be sent when PTP state changed (e.g. from 'passive' to 'master')
Reference to other chapters: [LTOS 6 Managm./Mon.](#) → [Web GUI](#) → [PTP](#) → [PTP Global Status](#)
Cleared By: -

SNMP Trap Name: mbgLtNgTrapPtpError
OID: .1.3.6.1.4.1.5597.30.3.0.40
Severity: Warning Critical
Short explanation: trap to be sent when PTP raised an error
Reference to other chapters: [LTOS 6 Managm./Mon.](#) → [Web GUI](#) → [PTP](#) → [PTP Global Status](#)
Cleared By: -

SNMP Trap Name: mbgLtNgTrapLowSystemResources
OID: .1.3.6.1.4.1.5597.30.3.0.41
Severity: Clearing event
Short explanation: trap to be sent when system is running on low resources
Reference to other chapters: no further information
Cleared By: mbgLtNgTrapSufficientSystemResources

SNMP Trap Name: mbgLtNgTrapFanDown
OID: .1.3.6.1.4.1.5597.30.3.0.45
Severity: Critical
Short explanation: trap to be sent when fan goes down
Reference to other chapters: [Troubleshooting and Alarming](#) → [Miscellaneous](#) → [Fan Failure](#)
Cleared By: mbgLtNgTrapFanUp

SNMP Trap Name: mbgLtNgTrapFanUp
OID: .1.3.6.1.4.1.5597.30.3.0.46
Severity: Clearing event
Short explanation: trap to be sent when fan comes up
Reference to other chapters: no further information
Cleared By: -

SNMP Trap Name: mbgLtNgTrapCertificateExpired
OID: .1.3.6.1.4.1.5597.30.3.0.47
Severity: Info or warning
Short explanation: trap to be sent when HTTPS certificate expires or will expire
Reference to other chapters: [LTOS 6 Managm./Mon.](#) → [Web GUI](#) → [Security](#) → [HTTPS Certificate](#)
Cleared By: -

| | |
|-------------------------------------|---|
| SNMP Trap Name: | mbgLtNgTrapSufficientSystemResources |
| OID: | .1.3.6.1.4.1.5597.30.3.0.48 |
| Severity: | Clearing event |
| Short explanation: | trap to be sent when system has regained sufficient resources |
| Reference to other chapters: | no further information |
| Cleared By: | - |

| | |
|-------------------------------------|--|
| SNMP Trap Name: | mbgLtNgTrapOscillatorWarmedUp |
| OID: | .1.3.6.1.4.1.5597.30.3.0.49 |
| Severity: | Clearing event |
| Short explanation: | trap to be sent when oscillator is warmed up |
| Reference to other chapters: | no further information |
| Cleared By: | - |

| | |
|-------------------------------------|---|
| SNMP Trap Name: | mbgLtNgTrapOscillatorNotWarmedUp |
| OID: | .1.3.6.1.4.1.5597.30.3.0.50 |
| Severity: | Info |
| Short explanation: | trap to be sent when oscillator is not warmed up |
| Reference to other chapters: | Troubleshooting and Alarming → Ref. Clock → Oscillator not Adjusted |
| Cleared By: | mbgLtNgTrapOscillatorWarmedUp |

| | |
|-------------------------------------|---|
| SNMP Trap Name: | mbgLtNgTrapMrsRefChanged |
| OID: | .1.3.6.1.4.1.5597.30.3.0.51 |
| Severity: | Info Warning |
| Short explanation: | trap to be sent when MRS reference source changed |
| Reference to other chapters: | no further information |
| Cleared By: | - |

| | |
|-------------------------------------|---|
| SNMP Trap Name: | mbgLtNgTrapClusterMasterChanged |
| OID: | .1.3.6.1.4.1.5597.30.3.0.52 |
| Severity: | Warning |
| Short explanation: | trap to be sent when cluster mode is active and cluster changed |
| Reference to other chapters: | LTOS 6 Managm./Mon. → Web GUI → Network → Network Interf. - Cluster |
| Cleared By: | - |

| | |
|-------------------------------------|---|
| SNMP Trap Name: | mbgLtNgTrapClusterFalsetickerDetected |
| OID: | .1.3.6.1.4.1.5597.30.3.0.53 |
| Severity: | Warning |
| Short explanation: | trap to be sent when cluster mode is active and a cluster member is detected as falseticker |
| Reference to other chapters: | LTOS 6 Managm./Mon. → Web GUI → Network → Network Interf. - Cluster |
| Cleared By: | mbgLtNgTrapClusterFalsetickerCleared |

| | |
|-------------------------------------|---|
| SNMP Trap Name: | mbgLtNgTrapClusterFalsetickerCleared |
| OID: | .1.3.6.1.4.1.5597.30.3.0.54 |
| Severity: | Clearing event |
| Short explanation: | trap to be sent when cluster mode is active and a cluster member is no longer a falseticker |
| Reference to other chapters: | no further information |
| Cleared By: | - |

| | |
|------------------------------|---|
| SNMP Trap Name: | mbgLtNgTrapSHSTimeLimitOk |
| OID: | .1.3.6.1.4.1.5597.30.3.0.55 |
| Severity: | Info |
| Short explanation: | trap to be sent when SHS timelimit error has been acknowledged or time difference drops below warning limit |
| Reference to other chapters: | LTOS 6 Managm./Mon. → Web GUI → Introduction |
| Cleared By: | - |
| SNMP Trap Name: | mbgLtNgTrapIMSError |
| OID: | .1.3.6.1.4.1.5597.30.3.0.56 |
| Severity: | Critical |
| Short explanation: | trap to be sent when an IMS module is not responsive anymore has got temperature issues, etc. |
| Reference to other chapters: | Troubleshooting and Alarming → Miscellaneous → IMS Error |
| Cleared By: | mbgLtNgTrapIMSOk |
| SNMP Trap Name: | mbgLtNgTrapIMSOk |
| OID: | .1.3.6.1.4.1.5597.30.3.0.57 |
| Severity: | Clearing event |
| Short explanation: | trap to be sent when an IMS module returns to healthy state |
| Reference to other chapters: | no further information |
| Cleared By: | - |
| SNMP Trap Name: | mbgLtNgTrapFDMOk |
| OID: | .1.3.6.1.4.1.5597.30.3.0.58 |
| Severity: | Clearing event |
| Short explanation: | trap to be sent when an FDM module returns to healthy state |
| Reference to other chapters: | LTOS 6 Managm./Mon. → Web GUI → FDM → FDM Configuration |
| Cleared By: | - |
| SNMP Trap Name: | mbgLtNgTrapNTPOffsetLimitExceeded |
| OID: | .1.3.6.1.4.1.5597.30.3.0.59 |
| Severity: | Error |
| Short explanation: | trap to be sent when monitoring an NTP client and its offset limit is exceeded |
| Reference to other chapters: | Troubleshooting and Alarming → NTP → NTP Offset Limit Exceeded |
| Cleared By: | - |
| SNMP Trap Name: | mbgLtNgTrapNTPOffsetLimitOk |
| OID: | .1.3.6.1.4.1.5597.30.3.0.60 |
| Severity: | Info |
| Short explanation: | trap to be sent when monitoring an NTP client and its offset limit is back again in a valid range |
| Reference to other chapters: | no further information |
| Cleared By: | mbgLtNgTrapNTPOffsetLimitExceeded |
| SNMP Trap Name: | mbgLtNgTrapXheRubError |
| OID: | .1.3.6.1.4.1.5597.30.3.0.61 |
| Severity: | Info |
| Short explanation: | trap to be sent when external rubidium announces OK |
| Reference to other chapters: | no further information |
| Cleared By: | - |

| | |
|-------------------------------------|--|
| SNMP Trap Name: | mbgLtNgTrapXheRubError |
| OID: | .1.3.6.1.4.1.5597.30.3.0.62 |
| Severity: | Error |
| Short explanation: | trap to be sent when external rubidium announces error |
| Reference to other chapters: | no further information |
| Cleared By: | - |

| | |
|-------------------------------------|---|
| SNMP Trap Name: | mbgLtNgTrapPowerConsumptionExceeded |
| OID: | .1.3.6.1.4.1.5597.30.3.0.63 |
| Severity: | Warning |
| Short explanation: | trap to be sent when device consumes too much power |
| Reference to other chapters: | no further information |
| Cleared By: | mbgLtNgTrapPowerConsumptionOk |

| | |
|-------------------------------------|--|
| SNMP Trap Name: | mbgLtNgTrapPowerConsumptionOk |
| OID: | .1.3.6.1.4.1.5597.30.3.0.64 |
| Severity: | Info |
| Short explanation: | trap to be sent when device has got enough power |
| Reference to other chapters: | no further information |
| Cleared By: | - |

| | |
|-------------------------------------|--|
| SNMP Trap Name: | mbgLtNgTrapPowerRedundancyNotAvail |
| OID: | .1.3.6.1.4.1.5597.30.3.0.65 |
| Severity: | Warning |
| Short explanation: | trap to be sent when there currently is no power supply backup avail |
| Reference to other chapters: | no further information |
| Cleared By: | mbgLtNgTrapPowerRedundancyAvail |

| | |
|-------------------------------------|---|
| SNMP Trap Name: | mbgLtNgTrapPowerRedundancyAvail |
| OID: | .1.3.6.1.4.1.5597.30.3.0.66 |
| Severity: | Info |
| Short explanation: | trap to be sent when there is at least one power supply as backup |
| Reference to other chapters: | no further information |
| Cleared By: | - |

| | |
|-------------------------------------|---|
| SNMP Trap Name: | mbgLtNgTrapTrustedSourceError |
| OID: | .1.3.6.1.4.1.5597.30.3.0.67 |
| Severity: | Warning |
| Short explanation: | trap to be sent when a MRS source's time deviation exceeds a configured limit |
| Reference to other chapters: | no further information |
| Cleared By: | mbgLtNgTrapTrustedSourceOk |

| | |
|-------------------------------------|---|
| SNMP Trap Name: | mbgLtNgTrapTrustedSourceOk |
| OID: | .1.3.6.1.4.1.5597.30.3.0.68 |
| Severity: | Clearing Event |
| Short explanation: | trap to be sent when a MRS source's time deviation returns to its configured bounds |
| Reference to other chapters: | no further information |
| Cleared By: | - |

| | |
|-------------------------------------|---|
| SNMP Trap Name: | mbgLtNgTrapNormalOperation |
| OID: | .1.3.6.1.4.1.5597.30.3.0.77 |
| Severity: | Clearing event |
| Short explanation: | trap to be sent when the system returned to a healthy state |
| Reference to other chapters: | no further information |
| Cleared By: | - |

| | |
|-------------------------------------|---|
| SNMP Trap Name: | mbgLtNgTrapHeartbeat |
| OID: | .1.3.6.1.4.1.5597.30.3.0.88 |
| Severity: | Info |
| Short explanation: | trap to be sent periodically to indicate that time server is still alive |
| Reference to other chapters: | LTOS 6 Managem./Mon. → Notifications → Miscellaneous - Enable Heartbeat |
| Cleared By: | - |

| | |
|-------------------------------------|---|
| SNMP Trap Name: | mbgLtNgTrapTestNotification |
| OID: | .1.3.6.1.4.1.5597.30.3.0.99 |
| Severity: | Info |
| Short explanation: | trap to be sent when a test notification has been requested |
| Reference to other chapters: | no further information |
| Cleared By: | - |

10 Troubleshooting and Alarming

10.1 NTP Messages

Error and System message / Explanation

NTP Not Sync /

The NTP service of a LANTIME is not sync.

Troubleshooting / Additional information

- For LANTIMEs with built-in reference clock, please check the status of the clock on the main page. If the reference clock is not synchronized, please refer to the troubleshooting information for "CLK Not Sync".
- For LANTIMEs, which are to be synchronized by external NTP servers, make sure that the external NTP servers are reachable.
- For MRS devices, check whether MRS reference time sources are configured in the Web interface (→ Clock → MRS settings) and corresponding signals are available (→ Clock → MRS status).
- Contact your Meinberg TechSupport and provide a LANTIME diagnostic file, if you need further assistance at solving the problem.

NTP Stopped /

The NTP service stopped

- Info: After every configuration change relevant to the NTP, the NTP service is stopped and restarted. In this case, a message 'NTP Stopped' is written into the system log of the LANTIME.
- Contact the Meinberg TechSupport and provide a LANTIME diagnostic file, if 'NTP Stopped' is permanently displayed as NTP status in the front panel or in the web interface.

NTP Offset Limit Exceeded /

LANTIME generates this message if the internal time offset between LANTIME system time and the reference clock is higher than the configured threshold value.

- Check the configured threshold value in the Web Interface: "NTP → Special Settings → Max. Internal Offset (ms.)"
- Note: After restarting the LANTIME it takes several minutes, depending on the reference time source, until the internal offset is $< \pm 1$ ms.
- Contact your Meinberg TechSupport and provide a LANTIME diagnostic file, if you need further assistance at solving the problem.

10.2 Ref. Clock Messages

Error and System message / Explanation

CLK Not Responding /

The LANTIME can no longer communicate with its internal reference clock.

CLK Not Sync /

Performance and system resources issue of the NTP

Troubleshooting / Additional information

- Contact your Meinberg TechSupport and provide a LANTIME diagnostic file.

LANTIME with GNSS reference clock (GPS/GLN/GNS):

- Check the antenna position:
- If the GPS reference clock is connected to a GPS antenna distributor GPSAV4 (<https://www.meinbergglobal.com/english/products/gps-antenna-distributor.htm>), make sure that the "Clock 1" port of the GPSAV4 is attached, since the GPSAV4 and the antenna are supplied by power via this port.

LANTIME with a longwave receiver (DCF77-PZF/WWVB/MSF/JJY):

- Check the antenna position

LANTIME with TCR reference clock (IRIG):

- Check whether the timecode input port at the back of the LANTIME is correctly connected to an IRIG source. In the Web interface, check whether the correct IRIG input code has been configured (Clock → IRIG Settings → Input Timecode). The input timecode is the IRIG code provided to the LANTIME by the IRIG source.
- Contact your Meinberg TechSupport and provide a LANTIME diagnostic file, if you need further assistance at solving the problem.

Antenna Faulty /

GNSS reference clock (GPS/GLN/GNS):
The antenna has not been detected.

- Check the connections between the antenna and a LANTIME.
- Check the output voltage at the LANTIME antenna connector.
- To do this, disconnect the antenna cable from the LANTIME antenna port. The following voltage value should
- be measured between the inner and outer conductor:
 - GPS Receiver → 15-18 V DC
 - GLN Receiver → 5V DC
 - GNS Receiver → 5V DC
- If the voltage is 0V DC, please contact the Meinberg TechSupport:
- If the measured voltage at the antenna port of the LANTIME is correct, reconnect the antenna cable and
- check the voltage at the other end of the antenna cable.
- Contact your Meinberg TechSupport and provide a LANTIME diagnostic file, if you need further assistance at solving the problem.

Longwave receiver (DCF77-PZF/WWVB/MSF/JJY):
Either the antenna or any other input signal has not been detected.

- Check the connections between the antenna and a LANTIME.
- Check the status of the received antenna signal in the main page of the web interface. The displayed field strength value should be > 40 . If this is not the case, please check how the antenna is positioned.
- Check the output voltage at the LANTIME antenna connector.
- To do this, disconnect the antenna cable from the LANTIME antenna port. The following voltage value should be measured between the inner and outer conductor: Long Wave Receiver → 5 V DC
- Contact your Meinberg TechSupport and provide a LANTIME diagnostic file, if you need further assistance at solving the problem.

Antenna Short Circuit /

Short circuit at the antenna connection.

- Disconnect the antenna cable from the LANTIME antenna connector.
- Perform a powercycle of the device
- If the LANTIME does not show the error message after the start-up, connect the antenna again. Otherwise contact the Meinberg TechSupport and provide a LANTIME diagnostic file.

GPS Warm Boot /

In warm boot mode, the GPS reference clock performs the position determination. To complete this process successfully, at least 4 satellites should be received. After successful position determination, the position will be stored in the battery-buffered memory of the clock. Thus the position determination does not to be carried out again after a restart.

- If the LANTIME can not complete the GPS warm boot process, check the number of "good satellites" that can be viewed in the web interface: "Clock → GPS (GNSS Clock → Receiver Information → Number of good satellites".
- If the number of good satellites is permanently below 4 and the LANTIME can not complete the position determination, then refer to the troubleshooting case for "CLK Not Sync".
- Contact your Meinberg TechSupport and provide a LANTIME diagnostic file, if you need further assistance at solving the problem.

GPS Cold Boot /

In GPS Cold Boot mode, the GPS reference clock tries to download the GPS almanac, which contains the satellite track data for all satellites. To complete this process, at least 1 satellite should be received. The process takes at least 12 minutes. After the cold boot is completed, the clock automatically switches to the GPS warm boot to determine the position.

The GPS almanac is stored in the battery-buffered memory of the clock.

- If the LANTIME can not complete the GPS Cold Boot operation after more than 30 minutes, check the number of "good satellites" in the web interface: "Clock → GPS (GNSS Clock → Receiver Information → Number of good satellites".
- If the number of good satellites is 0, then refer to the troubleshooting case for "CLK Not Sync".
- Contact your Meinberg TechSupport and provide a LANTIME diagnostic file, if you need further assistance at solving the problem.

SHS Time Limit Warning /

LANTIME systems with two built-in reference clocks send out this message as soon as the time difference between both clocks exceeded the pre-configured "Time Limit Warning Level" setting.

- Check the current time difference between the two reference clocks in the main menu of the web interface.
- Check your SHS configuration under "Security → SHS Configuration". Are the configured thresholds possibly too strict?
- Check the status of both reference clocks in the main menu of the web interface. If one of the two clocks is not synchronized, please refer to the troubleshooting case for "CLK Not Sync".
- Contact your Meinberg TechSupport and provide a LANTIME diagnostic file, if you need further assistance at solving the problem.

Oscillator not Adjusted /

The internal oscillator is not (yet) fully disciplined. As soon as this process is finished, the LANTIME sends out a log message "Oscillator Adjusted". The time needed for an oscillator to be disciplined depends on the quality of the incoming signal, the aging and environmental influences on the oscillator.

- Contact your Meinberg TechSupport and provide a LANTIME diagnostic file, if you need further assistance at solving the problem.

Leap Second Announced /

LANTIMEs with a GNSS reference clock (GPS / GLN / GNS) or long wave receiver (DCF77-PZF / WWVB / MSF / JJY) send out the "Leap Second Announced" notification message as soon as they have received the announcement by the reference signal. The GPS satellites announce the upcoming leapsecond usually about half a year in advance. Long wave transmitters usually send the announcement 1 hour in advance.

- This is only an info notification, therefore no further action is required.

MRS Limit Exceed /

LANTIME generates this message when the measured time offset of an MRS time source has exceeded the configured threshold value.

- Check the current MRS time source status in the Web Interface under "Clock → GNSS Clock → MRS Status".
- Check the MRS configuration in the Web Interface under "Clock → GNSS Clock → MRS Settings". Are the configured threshold values (check the "Limit" column) configured possibly too strict?
- Contact your Meinberg TechSupport and provide a LANTIME diagnostic file, if you need further assistance at solving the problem.

MRS Reference Disconnected /

LANTIME generates this message if the configured MRS time source is no longer available.

- Contact your Meinberg TechSupport and provide a LANTIME diagnostic file, if you need further assistance at solving the problem.

MRS Source: Invalid Signal

The LANTIME server will generate this message if an MRS input signal is present but does not satisfy certain requirements such as signal quality. Example: The PTP GM is receiving a PTP signal, but this signal is not of the minimum clock class required by the Slave.

- Contact your Meinberg TechSupport and provide a LANTIME diagnostic file, if you need further assistance at solving the problem.

10.3 Network Messages

Error and System message / Explanation

Network Link Down /

There was no link detected at one of the LANTIME's network interface.

Troubleshooting / Additional information

- Check which ports are physically connected and the link should be available.
- Check for compatible network settings on switch and LANTIME.
- Check the settings for link monitoring via the Web Interface: "Network → Physical Network Configuration → Indicate Link on Front Panel LED".
 - The LANTIME monitors a link status for the ports where the "Indicate Link on Front Panel LED" option is activated.
- Contact your Meinberg TechSupport and provide a LANTIME diagnostic file, if you need further assistance at solving the problem.

10.4 Miscellaneous Messages

Error and System message / Explanation

Fan Failure /

The LANTIME has detected a fault on a fan module, or a fan module has been removed during system operation.

Troubleshooting / Additional information

- If the fan module has not been intentionally removed, contact the Meinberg TechSupport and provide a LANTIME diagnostic file.

IMS Error /

Either the LANTIME has detected an error on an IMS module or an IMS module has been plugged out of the LANTIME IMS system during the operation.

Troubleshooting / Additional information

- If the IMS module has not been intentionally removed, contact the Meinberg TechSupport and provide a LANTIME diagnostic file.

CPU No Response (This error message can only appear on a display) /

The display does not receive any information from the installed LANTIME CPU unit.

Troubleshooting / Additional information

- Check whether the LANTIME is still available over the network (try to ping, SSH, HTTP / HTTPS)
- Does a power cycle solve this problem?
- If the LANTIME is still accessible via HTTP / HTTPS, please download a diagnostic file via the web interface and send it to the Meinberg TechSupport. If no connection to the LANTIME is possible, contact the Meinberg TechSupport with the serial number of your LANTIME.

Certificate Expired /

LANTIME generates this warning 60 days, 30 days, and 15 days before the end period of the installed SSL certificate for HTTPS service.

Troubleshooting / Additional information

- Check the validity of the installed SSL certificate via the Web Interface: "Security → HTTPS Certificate → Show SSL Certificate".
- Upload a new SSL certificate using the LANTIME Web Interface in the Security Page dialogue.: "Security → HTTPS Certificate → Upload SSL Certificate".
- Contact your Meinberg TechSupport and provide a LANTIME diagnostic file, if you need further assistance at solving the problem.

Low System Resource /

LANTIME generates this warning:

directory "/var" < 1MB free

directory "/var" > 90% usage

RAM Mem free < 6MB

Troubleshooting / Additional information

- Contact your Meinberg TechSupport and provide a LANTIME diagnostic file, if you need further assistance for solving the problem.

11 Support Information

In this chapter you will learn about different levels of support at the Meinberg Company. In general, the Basic Customer Support level is included in the price you pay for your Meinberg product and demands no additional costs. It includes free e-mail, phone support and free lifetime firmware updates for the lifetime of your product, i.e. for as long as you choose to use it.

Depending on the product this level also includes a 2 or 3 year hardware warranty. You can extend the hardware warranty period after the standard warranty of your Meinberg product ends.

The chapter includes:

- Basic Customer Support
- Support Ticket System
- How to download a Diagnostic File
- Self-Help Online Tools
- NTP and IEEE 1588-PTP online tutorials
- The Meinberg Academy introduction and offerings
- Meinberg Newsletter

11.1 Basic Customer Support

Contact Meinberg via e-mail or phone.

| Technical Support | |
|-----------------------|--|
| E-Mail | techsupport@meinberg.de |
| Service hotline | +49 (0) 5281 / 9309-888 |
| Service hours hotline | Mon – Thu 8:00 – 17:00, Fri 8:00 – 16:00 (CET/CEST) Not available on Sat/Sun and German Public Holidays |

| Office (Sales/Purchase) | |
|-------------------------|---|
| E-Mail | info@meinberg.de |
| Service hotline | +49 (0) 5281 / 9309-888 |
| Service hours hotline | Mon – Thu 7:30 – 17:00, Fri 07:30 – 15:00 (CET/CEST) Not available on Sat/Sun and German Public Holidays |

MEINBERG Remote Support

In order to assist you with configuration, installation, monitoring and diagnostics of your Meinberg products, you can download a remote support software that allows Meinberg technical support to remote control your computer.

By following this link:

<https://www.meinbergglobal.com/english/support/remote.htm>

you can find all necessary information and to download the support.

LANTIME Firmware Updates

To check if an update is available for your LANTIME, please visit;

<https://www.meinbergglobal.com/english/sw/firmware.htm>

and fill out the form. Available firmware updates will be provided by e-mail (LANTIME firmware V5 or older versions) or with a direct download link (LANTIME firmware V6 or newer).

11.2 Support Ticket System

Meinberg assists you quickly and directly on questions regarding the initial setup of your devices, troubleshooting or if you want to update the hard- or software. We offer free support for the whole lifetime of your Meinberg product.

- Send a mail to techsupport@meinberg.de with a description of your issue.
- A support ticket will automatically be opened.
- Our support engineers will contact you as soon as possible.
- It is always helpful for our engineers to receive a diagnostic file when you send a ticket.
- The diagnostic file includes all status data of a LANTIME system logged since the last reboot and can be downloaded from all LANTIME timeservers. The file format of the diagnostic file is a tgz-archive. → See chapter [How to download a Diagnostic File](#) how to generate this file at your LANTIME system.

11.3 How to download a Diagnostic File

In most support cases the first action is to ask the customer to download the diagnostic file, because it is very helpful at identifying the current state of the LANTIME and finding possible errors. Therefore we recommend that you attach your Diagnostic File when sending a ticket to our support.

The diagnostic file includes all status data of a LANTIME system logged since the last reboot. It can be downloaded from all LANTIME timeservers or you can save the file on a USB stick connected to the device. The file format of the diagnostic file is a tgz-archive. The archive contains all the important configuration and logfiles.

11.3.1 Download via Web GUI

- Connect to the Web GUI by putting the IP address into the address field of the web browser.
- Open the „System“ page and the submenu "Diagnostics".
- Press the "Download Diagnostic File" button.

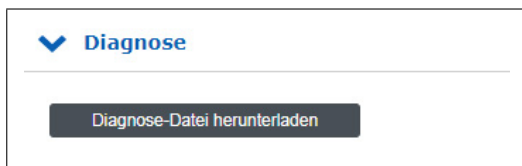

- The file will take some time to be created as its size is several MBs. After the file has been created it will be automatically sent to your web browser. Then save the file to your local hard disk.
- The diagnostic file is named "*lt_diag_SERIALNUMBER.tgz*" and the file format is a tgz archive. You can open the tgz archive e.g. with 7Zip (<https://www.7-zip.org/>).

11.3.2 Download via USB Stick

- The USB stick have to be formatted in a linux compatible file system like FAT. Connect a USB stick to the USB port of the LANTIME:
- The USB Memory Stick Menu opens automatically. Press „OK“ to confirm.
- You can use the up and down arrows to move through the menu.
- Use the „Write diagnostic File to USB stick“ option to write the current diagnostic file to the USB stick.
- You can find the Diagnostic File by opening the LANTIME folder and continue on to the Diag folder.

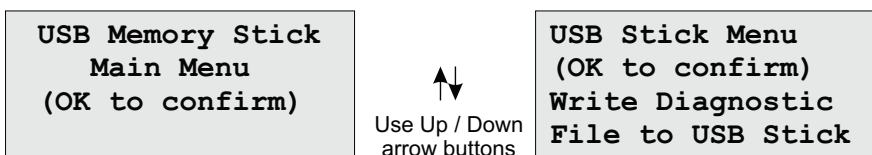

11.4 Self-Help Online Tools

Here is the list of some informative websites where you can query different information about the Meinberg Systems.

1. Meinberg Homepage – general:
<https://www.meinbergglobal.com/>
2. NTP Download – at Meinberg:
<https://www.meinbergglobal.com/english/sw/>
3. NTP Client Download for Windows (NTP-time-server-monitor):
<https://www.meinbergglobal.com/english/sw/ntp-server-monitor.htm>
4. LANTIME firmware update request online form:
<https://www.meinbergglobal.com/english/sw/firmware.htm>
5. Download page for Meinberg software, drivers and software:
<https://www.meinbergglobal.com/english/sw/>
6. All Meinberg manuals (ENG, German versions):
<https://www.meinbergglobal.com/english/docs/>
7. Meinberg Newsletter and subscription page:
<https://www.meinbergglobal.com/english/company/news.htm>
8. NTP / IEEE 1588-PTP online tutorials from Meinberg:
<http://blog.meinbergglobal.com/>
9. FAQs about Meinberg Products:
<https://www.meinbergglobal.com/english/faq/>
10. Meinberg Knowledgebase:
<https://kb.meinbergglobal.com>
11. GPS / GNSS Antenna Installation and mounting:
<https://www.meinbergglobal.com/english/info/gps-antenna-mount.htm>
<https://www.youtube.com/watch?v=ZTJMKS180GY> (YouTube video)
12. NTP support page and documentation:
<http://support.ntp.org/bin/view/Support/WebHome>

11.5 NTP and IEEE 1588-PTP online tutorials

A team of Meinberg engineers are writing online tutorials covering topics on IEEE 1588 PTP, NTP, synchronization setups and configurations used in different industries.

The tutorials can be found at:
<http://blog.meinbergglobal.com/>

The blog provides you also the opportunity to write a comment or a question to our experts and get their reply.

Categories:

Configuration Guidelines, IEEE 1588, Industry Applications, NTP and Security.

11.6 The Meinberg Academy introduction and offerings

Meinberg Sync Academy (MSA) is an institution within the Meinberg Company which takes care for education and expert knowledge dissemination in the field of time and frequency synchronization. The academy offers tutorials and courses on the latest synchronization technologies such as NTP, IEEE 1588-PTP, synchronization networks for different industries: telecom, power, broadcasting, professional audio/video, finance, IT and . The MSA courses include both, theoretical lectures and practical hands-on labs.

If you are planning or re-designing synchronization for your networks and you need additional knowledge, see our agenda for the upcoming courses.

Homepage: <https://www.meinbergglobal.com/english/support/meinberg-sync-academy.htm>

Courses: Meinberg Product Training, NTP Complete, PTP Complete
Customized Trainings and Online Trainings.

Contact Phone: +49 (0) 5281 93093-0

E-Mail: info@meinberg.de

11.7 Meinberg Newsletter

Meinberg publishes regularly up-to-date information, technical news, firmware updates and security advisory by the Meinberg Newsletter in both the English and German language.

Subscribe to the newsletter here:

<https://www.meinbergglobal.com/english/contact/newslett.htm>

12 Appendix

12.1 LANTIME CPU - Central Processing Unit

Booting the Single Board Computer

The LINUX operating system is loaded from a packed file on the flash disk of the single board computer to a RAM disk. All files of the flash disk are stored in the RAM disk after booting. Because of that it is guaranteed that the file system is in a defined condition after restart. This boot process takes approx. two minutes. During this time the following message appears on the display:

```
MEINBERG LANTIME
is booting ...
please wait ...
.....
```

After starting up the LINUX system the network function is initiated and the program for communication with the reference clock and the NTPD (NTP daemon) is started. After that NTPD starts synchronization with the reference clockss (usual the hardware clock of the single board computer and the used receiver). Until synchronization is finished the following message is displayed:

```
CLK: Not Sync
NTP: Sync to OSC
Wed, dd.mm.yyyy
UTC 12:00:00
```

For the synchronization of the NTPD, e.g. with a GPS creceiver, it is necessary that the GPS receiver is synchronous with the GPS time. In this case the following message is shown on the display:

```
NORMAL OPERATION
NTP: Offs. 2ms
Wed, dd.mm.yyyy
UTC 12:00:00
```

The second line shows the user that the NTPD is synchronized with the GPS with an offset of -50us. Because of the internal time of the NTP which is adjusted by a software PLL (phase locked loop) it takes a certain time to optimise this offset. The NTPD tries to keep the offset below +-128 ms; if the offset becomes too large the system time is set with the GPS time. Typically values for the offset are +-5 ms after the NTPD has already synchronized.

12.1.1 Technical Specifications LAN CPU

CPU Module Type C05F1:

| | |
|-----------------------------|---|
| Processor: | AMD Geode™ LX 800 (500 MHz, 128 KB L2 cache, 3.6 W) |
| Main Memory: | onboard 256 MByte |
| Flashdisk: | 1 GB |
| Network Connector: | 10/100 MBIT with RJ45-Jack |
| Power Requirements: | 5 V +- 5 %, @ 1 A |
| Frontpanel: | 3U / 4TE (128 mm high x 20,3 mm wide) |
| Ambient Temperature: | 0 ... 50 °C |
| Storage Temperature: | -20 ... 70 °C |
| Humidity: | 85 % max. |

12.1.2 Technical Specifications - IMS CPU-C15G2

As the central management and control element, the CPU module in an LANTIME system is responsible for management, configuration and alarm notifications. It additionally provides NTP and SNTP services on its network interface. The CPU-C15G2 is equipped with two integrated network interfaces, additional network ports can be added by installing LNE modules.

| | |
|---------------------------|---|
| Processor: | Intel® Atom™ Processor E Series (2 Cores, 1.33GHz, TDP 3W) |
| Main Memory: | onboard 2 GB |
| Cache Memory: | 1MB 2nd Level Cache |
| Flash Disk: | 4 GB |
| Network Connector: | 1 x 10/100/1000 Base-T with RJ45-Jack 1 x 1000Base-T with SFP-Jack |
| Serial Interface: | RJ45 connector console: 38400 / 8N1, connection via CAB-CONSOLE cable |
| USB Port: | install firmware upgrades backup and restore configuration files copy security keys lock / unlock front keys |
| Operating System: | GNU/Linux 4.x |
| State LEDs: | <p>LAN 0 Interface LED - Connect, Activity and Speed of the network connection</p> <p>LAN-CPU R - Reference Time T - Time Service N - Network A - Alarm</p> |

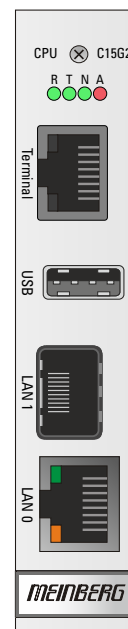

Supported Protocols:

| | |
|----------------------------------|--|
| Network Time Protocol (NTP): | NTP v2 (RFC 1119), NTP v3 (RFC 1305), NTP v4 (RFC 5905) SNTP v3 (RFC 1769), SNTP v4 (RFC 4330) |
| OSI Layer 2 (Data Link Layer): | PRP (IEC 62439-3) |
| OSI Layer 3 (Network Layer): | IPv4, IPv6 |
| OSI Layer 4 (Transport Layer): | TCP, UDP, TIME (RFC 868), DAYTIME (RFC 867), SYSLOG |
| OSI Layer 7 (Application Layer): | HTTP / HTTPS (RC 2616), DHCP, FTP, NTPv3 / NTPv4, SNTP, RADIUS, TACACS, FTP, SSH (incl. SFTP, SCP) - SSH v1.3 / SSH v1.5 / SSH v2 (OpenSSH), SNMPv1 (RFC 1157) / SNMPv2c (RFC 1901-1908) / SNMP v3 (RFC 3411-3418), Telnet (RFC 854-RFC 861) |

Environmental:

| | |
|-----------------------------|---------------------------|
| Ambient Temperature: | 0 ... 50°C / 32 ... 122°F |
| Humidity: | Max. 85% |

12.2 Description of Time String Formats

12.2.1 Format of the Meinberg Standard Time String

The Meinberg Standard Time String is a sequence of 32 ASCII characters starting with the <STX> (start-of-text) character and ending with the <ETX> (end-of-text) character. The format is as follows:

<STX>*D:dd.mm.yy;T:w;U:hh.mm.ss;uvxy*<ETX>

The letters printed in italics are replaced by ASCII-formatted numbers, whereas the other characters are directly part of the time string. The groups of characters as defined below:

| | |
|----------|--|
| <STX> | Start-of-Text, ASCII code 02h sent with one-bit accuracy at the change of each second |
| dd.mm.yy | The date: <i>dd</i> Day of Month (01–31) <i>mm</i> Month (01–12) <i>yy</i> Year of the Century (00–99) |
| w | The day of the week (1–7, 1 = Monday) |
| hh.mm.ss | The time: <i>hh</i> Hours (00–23) <i>mm</i> Minutes (00–59) <i>ss</i> Seconds (00–59, or 60 during leap second) |
| uv | Clock status characters (depending on clock type): u: '#' GPS: Clock is in free-run mode (no exact synchronization) PZF: Time frame not synchronized DCF77: Clock has not synchronized since last reset '' (space, 20h) GPS: Clock is synchronized (base accuracy is reached) PZF: Time frame is synchronized DCF77: Clock has synchronized since last reset v: '*' GPS: Receiver has not checked its position PZF/DCF77: Clock currently running off XTAL '' (space, 20h) GPS: Receiver has determined its position PZF/DCF77: Clock is synchronized with transmitter |
| x | time zone indicator: 'U' UTC Universal Time Coordinated, formerly GMT '' CET European Standard Time, daylight saving disabled 'S' (CEST) European Summertime, daylight saving enabled |
| y | Announcement of clock jump during last hour before jump enters effect: '!' Announcement of start or end of Daylight Saving Time 'A' Announcement of leap second insertion '' (Space, 20h) nothing announced |
| <ETX> | End-of-Text, ASCII code 03h |

12.2.2 Format of the Meinberg GPS Time String

The Meinberg GPS Time String is a sequence of 36 ASCII characters starting with the <STX> (start-of-text) character and ending with the <ETX> (end-of-text) character. Unlike the Meinberg Standard Time String, the Meinberg GPS Time String does not carry any local time zone or UTC data; it simply carries the direct GPS

time without any conversion into UTC. The format is as follows:

<STX>D:*dd.mm.yy*;T:w;U:*hh.mm.ss*;uvGy;lll<ETX>

The letters printed in *italics* are replaced by ASCII-formatted numbers, whereas the other characters are directly part of the time string. The groups of characters as defined below:

| | |
|-----------------|--|
| <STX> | Start-of-Text, ASCII code 02h |
| <i>dd.mm.yy</i> | The date: <i>dd</i> Day of Month (01–31) <i>mm</i> Month (01–12) <i>yy</i> Year of the Century (00–99) |
| w | the day of the week (1–7, 1 = Monday) |
| <i>hh.mm.ss</i> | the current time: <i>hh</i> Hours (00–23) <i>mm</i> Minutes (00–59) <i>ss</i> Seconds (00–59, or 60 while leap second) |
| uv | Clock status characters: u: '#' Clock is in free-run mode (no exact synchronization) '' (Space, 20h) Clock is synchronized (base accuracy is achieved) v: '*' Receiver has not checked its position '' (Space, 20h) Receiver has determined its position |
| G | 'GPS time' time zone indicator |
| y | Announcement of clock jump during last hour before jump enters effect: before discontinuity comes in effect: 'A' Announcement of leap second insertion '' (Space, 20h) nothing announced |
| lll | Number of leap seconds between UTC and GPS Time (UTC = GPS time + number of leap seconds) |
| <ETX> | End-of-Text, ASCII code 03h |

12.2.3 Format of the Meinberg Capture String

The Meinberg Capture String is a sequence of 31 ASCII characters terminated by a <CR>/<LF> (Carriage Return/Line Feed) combination. The format is as follows:

CH*x***_***dd.mm.yy_hh:mm:ss.ffffff***<CR><LF>**

The letters printed in italics are replaced by ASCII-formatted numbers, whereas the other characters are directly part of the time string. The groups of characters as defined below:

x 0 or 1 corresponding on the number of the capture input
 _ Space, ASCII code 20h

dd.mm.yy Capture date:

| | | |
|-----------|---------------------|---------|
| <i>dd</i> | Day of Month | (01–31) |
| <i>mm</i> | Month | (01–12) |
| <i>yy</i> | Year of the Century | (00–99) |

hh:mm:ss.ffffff Capture time:

| | | |
|---------------|-------------------------------|----------------------------------|
| <i>hh</i> | Hours | (00–23) |
| <i>mm</i> | Minutes | (00–59) |
| <i>ss</i> | Seconds | (00–59, or 60 while leap second) |
| <i>ffffff</i> | Fractions of Second, 7 Digits | |

<CR> Carriage Return, ASCII code 0Dh

<LF> Line Feed, ASCII code 0Ah

12.2.4 Format of the SAT Time String

The SAT Time String is a sequence of 29 ASCII characters starting with the <STX> (start-of-text) character and ending with the <ETX> (end-of-text) character. The format is as follows:

<STX>*dd.mm.yy/w/hh:mm:ssxxxuv*<ETX>

The letters printed in italics are replaced by ASCII-formatted numbers, whereas the other characters are directly part of the time string. The groups of characters are as defined below:

| | |
|----------|---|
| <STX> | Start-of-Text, ASCII code 02h sent with one-bit accuracy at the change of each second |
| dd.mm.yy | The date: <i>dd</i> Day of Month (01–31) <i>mm</i> Month (01–12) <i>yy</i> Year of the Century (00–99) |
| w | The day of the week (1 = Monday) |
| hh:mm:ss | The time: <i>hh</i> Hours (00–23) <i>mm</i> Minutes (00–59) <i>ss</i> Seconds (00–59, or 60 during leap second) |
| xxxx | Time zone indicator: 'UTC' Universal Time Coordinated, formerly GMT 'CET' European Standard Time, daylight saving disabled 'CEST' European Summertime, daylight saving enabled |
| u | Clock status characters: '#' Clock has not synchronized since last reset '' (Space, 20h) Clock has synchronized since last reset |
| v | Announcement of clock jump during last hour before jump enters effect: '!' Announcement of start or end of Daylight Saving Time '' (Space, 20h) nothing announced |
| <CR> | Carriage Return, ASCII code 0Dh |
| <LF> | Line Feed, ASCII code 0Ah |
| <ETX> | End-of-Text, ASCII code 03h |

12.2.5 Format of the Uni Erlangen String (NTP)

The Uni Erlangen String (NTP) of a GPS clock is a sequence of 66 ASCII characters starting with the <STX> (start-of-text) character and ending with the <ETX> (end-of-text) character. The format is as follows:

<STX>*dd.mm.yy; w; hh:mm:ss; voo:oo; acdfg i;bbb.bbbbn lll.lllle hhhhm*<ETX>

The letters printed in italics are replaced by ASCII-formatted numbers, whereas the other characters are directly part of the time string. The groups of characters are as defined below:

| | |
|----------|--|
| <STX> | Start-of-Text, ASCII code 02h sent with one-bit accuracy at the change of each second |
| dd.mm.yy | The date: <i>dd</i> Day of Month (01–31) <i>mm</i> Month (01–12) <i>yy</i> Year of Century (00–99) |
| w | Day of the week (1–7, 1 = Monday) |
| hh.mm.ss | The time: <i>hh</i> Hours (00–23) <i>mm</i> Minutes (00–59) <i>ss</i> Seconds (00–59, or 60 during leap second) |
| v | -/+ sign of the offset of local timezone relative to UTC |
| oo:oo | Offset of local time zone relative to UTC in hours and minutes |
| ac | Clock status characters: a: '#' Clock has not synchronized since reset ' ' (Space, 20h) Clock has synchronized since reset c: '**' GPS receiver has not checked its position ' ' (Space, 20h) GPS receiver has determined its position |
| d | Time zone indicator: 'S' CEST European Summertime, Daylight Saving Time enabled ' ' CET European Standard Time, Daylight Saving Time disabled |
| f | Announcement of clock jump during last hour before jump enters effect: '!' Announcement of start or end of Daylight Saving Time ' ' (Space, 20h) nothing announced |
| g | Announcement of clock jump during last hour before jump enters effect: 'A' Announcement of leap second insertion ' ' (Space, 20h) nothing announced |
| i | Leap second insertion 'L' Leap second is currently to be inserted (only active in 60th second) ' ' (Space, 20h) No leap second to be inserted |
| bbb.bbbb | Geographical latitude of receiver position in degrees Leading characters padded by Space characters (20h) |
| n | Latitudinal hemisphere, with the following characters possible: 'N' North of Equator |

'S' South of Equator

ll.llll Geographical longitude of receiver position in degrees
Leading characters padded by Space characters (20h)

e Longitudinal hemisphere, with the following characters possible:
'E' East of Greenwich Meridian
'W' West of Greenwich Meridian

hhhh Altitude above WGS84 ellipsoid in meters
Leading characters padded by Space characters (20h)

<ETX> End-of-Text, ASCII code 03h

12.2.6 Format of the NMEA 0183 String (RMC)

The NMEA 0183 RMC String is a sequence of 65 ASCII characters starting with the string '\$GPRMC' and ending with the characters <CR> (Carriage Return) and <LF> (Line Feed). The format is as follows:

```
$GPRMC,hhmmss.ss,A,bbbb.bb,n,llll.ll,e,0.0,0.0,ddmmyy,0.0,a*hh<CR><LF>
```

The letters printed in italics are replaced by ASCII-formatted numbers, whereas the other characters are directly part of the time string. The groups of characters are as defined below:

| | |
|-----------|---|
| \$ | Start character, ASCII code 24h sent with one-bit accuracy at the change of each second |
| GP | Talker ID, in this case "GP" for GPS |
| RMC | Message type ID, in this case "RMC" |
| hhmmss.ss | The time: <i>hh</i> Hours (00–23) <i>mm</i> Minutes (00–59) <i>ss</i> Seconds (00–59, or 60 while leap second) <i>ff</i> Fractions of Seconds (1/10 ; 1/100) |
| A | Status (A = Time Data Valid, V = Time Data not Valid) |
| bbbb.bb | Geographical latitude of receiver position in degrees Leading characters padded by Space characters (20h) |
| n | Latitudinal hemisphere, with the following characters possible: 'N' North of Equator 'S' South of Equator |
| llll.ll | Geographical longitude of receiver position in degrees Leading characters padded by Space characters (20h) |
| e | Longitudinal hemisphere, with following characters possible: 'E' East of Greenwich Meridian 'W' West of Greenwich Meridian |
| 0.0,0.0 | Speed over the ground in knots and track angle in degrees. With a Meinberg GPS clock, these values are always 0.0, With GNS clocks, the values are calculated by the receiver for mobile applications |
| ddmmyy | The date: <i>dd</i> Day of Month (01–31) <i>mm</i> Month (01–12) <i>yy</i> Year of the Century (00–99) |
| a | Magnetic Variation E/W |
| hh | Checksum (XOR of all characters except '\$' and '*') |
| <CR> | Carriage Return, ASCII code 0Dh |
| <LF> | Line Feed, ASCII code 0Ah |

12.2.7 Format of the NMEA 0183 String (GGA)

The NMEA 0193 GGA String is a sequence of characters starting with the string '\$GPGGA' and ending with the characters <CR> (Carriage Return) and <LF> (Line Feed). The format is as follows:

\$GPGGA,*hhmmss.ff,bbbb.bbbbb,n,llll.ll,e,A,vv,hhh.h,aaa.a,M,ggg.g,M,,0cs<CR><LF>**

The letters printed in italics are replaced by ASCII-formatted numbers, whereas the other characters are directly part of the time string. The groups of characters are as defined below:

| | |
|------------|--|
| \$ | Start character, ASCII code 24h sent with one-bit accuracy at the change of each second |
| GP | Talker ID, in this case "GP" for GPS |
| GGA | Message type ID, in this case "GGA" |
| hhmmss.ss | The time: <i>hh</i> Hours (00–23) <i>mm</i> Minutes (00–59) <i>ss</i> Seconds (00–59, or 60 while leap second) <i>ff</i> Fractions of Seconds (1/10 ; 1/100) |
| bbbb.bbbbb | Geographical latitude of receiver position in degrees Leading characters padded by Space characters (20h) |
| n | Latitudinal hemisphere, with the following characters possible: 'N' North of Equator 'S' South of Equator |
| llll.lllll | Geographical longitude of receiver position in degrees Leading characters padded by Space characters (20h) |
| e | Longitudinal hemisphere, with following characters possible: 'E' East of Greenwich Meridian 'W' West of Greenwich Meridian |
| A | Position fixed (1 = yes, 0 = no) |
| vv | Number of satellites used (0–12) |
| hhh.h | HDOP (Horizontal Dilution of Precision) |
| aaa.h | Mean Sea Level Altitude (MSL Altitude = WGS84 Altitude - Geoid Separation) |
| M | Units, Meters (Fixed Value) |
| ggg.g | Geoid Separation (WGS84 Altitude - MSL Altitude) |
| M | Units, Meters (Fixed Value) |
| cs | Checksum (XOR of all characters except '\$' and '*') |
| <CR> | Carriage Return, ASCII code 0Dh |
| <LF> | Line Feed, ASCII code 0Ah |

12.2.8 Format of the NMEA 0183 String (ZDA)

The NMEA 0183 ZDA String is a sequence of 38 ASCII characters starting with the string '\$GPZDA' and ending with the characters <CR> (Carriage Return) and <LF> (Line Feed). The format is:

\$GPZDA,*hhmmss.ss,dd,mm,yyyy,HH,IIcs<CR><LF>**

ZDA - Time and Date: UTC, day, month, year and local time zone.

The letters printed in italics are replaced by ASCII-formatted numbers, whereas the other characters are directly part of the time string. The groups of characters are as defined below:

\$ Start character, ASCII Code 24h
sending with one bit accuracy at change of second

hhmmss.ss UTC time:

| | | |
|-----------|---------|-----------------------------------|
| <i>hh</i> | Hours | (00–23) |
| <i>mm</i> | Minutes | (00–59) |
| <i>ss</i> | Seconds | (00–59, or 60 during leap second) |

HH,II The local time zone (offset to UTC):

| | | |
|-----------|---------|----------|
| <i>HH</i> | Hours | (00–±13) |
| <i>II</i> | Minutes | (00–59) |

dd,mm,yy The date:

| | | |
|-------------|--------------|-------------|
| <i>dd</i> | Day of Month | (01–31) |
| <i>mm</i> | Month | (01–12) |
| <i>yyyy</i> | Year | (0000–9999) |

cs Checksum (XOR of all characters except '\$' and '*')

<CR> Carriage Return, ASCII code 0Dh

<LF> Line Feed, ASCII code 0Ah

12.2.9 Format of the ABB SPA Time String

The ABB SPA Time String is a sequence of 32 ASCII characters starting with the characters ">900WD" and ending with the <CR> (Carriage Return) character. The format is as follows:

>900WD:yy-mm-tt_hh.mm;ss.fff:cc<CR>

The letters printed in italics are replaced by ASCII-formatted numbers, whereas the other characters are directly part of the time string. The groups of characters are as defined below:

yy-mm-tt The date:

yy Year of the Century (00–99)

mm Month (01–12)

dd Day of Month (01–31)

_ Space (ASCII code 20h)

hh.mm;ss.fff The time:

hh Hours (00–23)

mm Minutes (00–59)

ss Seconds (00–59, or 60 during leap second)

fff Milliseconds (000–999)

cc Checksum calculated as XOR sum of the preceding characters.
The resultant 8-bit value is reported as a hex value in the form of two ASCII characters (2 ASCII characters 0..9 or A..F)

<CR> Carriage Return, ASCII Code 0Dh

12.2.10 Format of the Comptime Time String

The Comptime Time String is a sequence of 24 ASCII characters starting with the T character and ending with the <LF> (Line Feed, ASCII code 0Ah) character. The format is as follows:

T:yy:mm:dd:ww:hh:mm:ss<CR><LF>

The letters printed in italics are replaced by ASCII-formatted numbers, whereas the other characters are directly part of the time string. The groups of characters are as defined below:

| | |
|----------|---|
| T | Start character sent with one-bit accuracy at the change of each second |
| yy:mm:dd | The date: yy Year of Century (00–99) mm Month (01–12) dd Day of Month (01–31) ww Day of Week (01–07, 01 = monday) |
| hh:mm:ss | The time: hh Hours (00–23) mm Minutes (00–59) ss Seconds (00–59, or 60 during leap second) |
| <CR> | Carriage Return, ASCII code 0Dh |
| <LF> | Line Feed, ASCII code 0Ah |

12.2.11 Format of the RACAL Standard Time String

The RACAL Standard Time String is a sequence of 16 ASCII characters started by a X (58h) character and ending with the <CR> (Carriage Return, ASCII code 0Dh) character. The format is as follows:

<X><G><U>*yymmddhhmmss*<CR>

The letters printed in italics are replaced by ASCII-formatted numbers, whereas the other characters are directly part of the time string. The groups of characters are as defined below:

| | | |
|-------------------|---|----------|
| <X> | Control character Sent with one-bit accuracy at the change of each second | Code 58h |
| <G> | Control character | Code 47h |
| <U> | Control character | Code 55h |
| yymmdd | Current date: yy Year of Century (00–99) mm Month (01–12) dd Day of Month (01–31) | |
| hh:mm:ss | Current time: hh Hours (00–23) mm Minutes (00–59) ss Seconds (00–59, or 60 during leap second) | |
| <CR> | Carriage Return, ASCII Code 0Dh | |

12.2.12 Format of the SYSPLEX-1 Time String

The SYSPLEX-1 time string is a sequence of 16 ASCII characters starting with the <SOH> (Start of Header) ASCII control character and ending with the <LF> (Line Feed, ASCII code 0Ah) character.

Please note:

To ensure that the time string can be correctly output and displayed through any given terminal program, a singular "C" (not include quotation marks) must be input.

The format is:

<SOH>ddd:hh:mm:ssq<CR><LF>

The letters printed in italics are replaced by ASCII numbers whereas the other characters are part of the time string. The groups of characters as defined below:

| | |
|----------|--|
| <SOH> | Start of Header, ASCII code 01h sent with one-bit accuracy at the change of each second |
| ddd | Day of Year (001–366) |
| hh:mm:ss | Current time: |
| hh | Hours (00–23) |
| mm | Minutes (00–59) |
| ss | Seconds (00–59, or 60 during leap second) |
| q | Quality Indicator (Space) Time Sync (GPS Lock) (?) No Time Sync (GPS Fail) |
| <CR> | Carriage Return (ASCII code 0Dh) |
| <LF> | Line Feed (ASCII code 0Ah) |

12.2.13 Format of the ION Time String

The ION time string is a sequence of 16 ASCII characters starting with the <SOH> (Start of Header) ASCII control character and ending with the <LF> (Line Feed, ASCII code 0Ah) character. The format is as follows:

<SOH>ddd:hh:mm:ssq<CR><LF>

The letters printed in italics are replaced by ASCII-formatted numbers, whereas the other characters are directly part of the time string. The groups of characters as defined below:

| | | |
|----------|---|---|
| <SOH> | Start of Header (ASCII control character) | |
| | sent with one-bit accuracy at the change of each second | |
| ddd | Day of Year | (001–366) |
| hh:mm:ss | Current time: | |
| hh | Hours | (00–23) |
| mm | Minutes | (00–59) |
| ss | Seconds | (00–59, or 60 while leap second) |
| q | Quality Indicator | (space) Time Sync (GPS Lock) (?) No Time Sync (GPS Fail) |
| <CR> | Carriage Return (ASCII code 0Dh) | |
| <LF> | Line Feed (ASCII code 0Ah) | |

12.2.14 Format of the ION Blanked Time String

The ION Blanked Time String is a sequence of 16 ASCII characters starting with the <SOH> (Start of Header) ASCII control character and ending with the <LF> (Line Feed, ASCII code 0Ah) character. The format is as follows:

<SOH>ddd:hh:mm:ssq<CR><LF>

Important: The blanking interval of is 2 minutes and 30 seconds long and is added every 5 minutes.

The letters printed in *italics* are replaced by ASCII-formatted numbers, whereas the other characters are directly part of the time string. The groups of characters as defined below:

| | | |
|----------|---|---|
| <SOH> | Start of Header (ASCII control character) | |
| | sent with one-bit accuracy at the change of each second | |
| ddd | Day of Year | (001–366) |
| hh:mm:ss | Current Time: | |
| hh | Hours | (00–23) |
| mm | Minutes | (00–59) |
| ss | Seconds | (00–59, or 60 while leap second) |
| q | Quality Indicator | (space) Time Sync (GPS Lock) (?) No Time Sync (GPS Fail) |
| <CR> | Carriage Return (ASCII Code 0Dh) | |
| <LF> | Line Feed (ASCII Code 0Ah) | |

12.2.15 Format of the IRIG-J Timecode

The IRIG-J timecode consists of a string of ASCII characters sent in "701" format:

- 1 Start Bit
- 7 Data Bits
- 1 Parity Bit (odd)
- 1 Stop Bit

The on-time marker of the string is the leading edge of the start bit. The timecode consists of 15 characters, sent once per second at a baud rate of 300 or greater. The format is as follows:

`<SOH>DDD:HH:MM:SS<CR><LF>`

The letters printed in italics are replaced by ASCII-formatted numbers, whereas the other characters are directly part of the time string. The groups of characters are as defined below:

`<SOH>` "Start of Header" ASCII code (0x01h)

DDD Day of the year (ordinal date, 1 to 366)

HH, MM, SS Time of the start bit, specified in in hours (*HH*), minutes (*MM*), seconds (*SS*)

`<CR>` "Carriage Return" ASCII code (0x0Dh)

`<LF>` "Line Feed" ASCII code (0x0Ah)

12.3 Description of Time Code Formats

Each IRIG format carries a designation comprising a letter followed by three numerical digits. The letter and each of the digits represents a characteristic property of the corresponding IRIG code.

Depending on your Meinberg product, more or less time code formats are supported.

| | |
|-------|---|
| A002: | 1000 pps, DCLS, pulse-width coded, no carrier Time of year (BCD) |
| A003: | 1000 pps, DCLS, pulse-width coded, no carrier Time of year (BCD), time of day (SBS) |
| A132: | 1000 pps, AM sine-wave signal, 10 kHz carrier frequency Time of year (BCD) |
| A133: | 1000 pps, AM sine-wave signal, 10 kHz carrier frequency Time of year (BCD), time of day (SBS) |
| B002: | 100 pps, DCLS, pulse-width coded, no carrier Time of year (BCD) |
| B003: | 100 pps, DCLS, pulse-width coded, no carrier Time of year (BCD), time of day (SBS) |
| B006: | 100 pps, DCLS, pulse-width coded, no carrier Time of year (BCD), calendar year (BCD) |
| B007: | 100 pps, DCLS, pulse-width coded, no carrier Time of year (BCD), year, time of day (SBS) |
| B122: | 100 pps, AM sine-wave signal, 1 kHz carrier frequency Time of year (BCD) |
| B123: | 100 pps, AM sine-wave signal, 1 kHz carrier frequency Time of year (BCD), time of day (SBS) |
| B126: | 100 pps, AM sine-wave signal, 1 kHz carrier frequency Time of year (BCD), calendar year (BCD) |
| B127: | 100 pps, AM sine-wave signal, 1 kHz carrier frequency Time of year (BCD), calendar year (BCD), time of day (SBS) |
| E002: | 10 pps, DCLS, pulse-width coded, no carrier Time of year (BCD) |
| E112: | 10 pps, AM sine wave signal, 100 Hz carrier frequency Time of year (BCD) |
| G002: | 10000 pps, DCLS, pulse-width coded, no carrier Time of year (BCD) |
| G006: | 10000 pps, DCLS, pulse-width coded, no carrier Time of year (BCD), calendar year (BCD) |
| G142: | 10000 pps, AM sine-wave signal, 100 kHz carrier frequency Time of year (BCD) |
| G146: | 10000 pps, AM sine-wave signal, 100 kHz carrier frequency Time of year (BCD), calendar year (BCD) |

Abbreviations:

BCD = Binary-Coded Decimal, SBS = Straight Binary Seconds

In addition to the original IRIG standards, there are also other specifications issued by other bodies that define specific extensions.

| | |
|---------------|--|
| AFNOR: | Code according to NF S87-500, 100 pps, AM sine-wave signal, 1 kHz carrier frequency, BCD time of year, complete date, SBS time of day, signal level specified by standard. |
| IEEE 1344: | Code according to IEEE 1344-1995, 100 pps, AM sine wave signal, 1kHz carrier frequency, BCD time of year, SBS time of day, IEEE 1344 extensions for date, time zone, Daylight Saving Time, and leap seconds in Control Functions (CF) segment. (See also table "Structure of CF segment in IEEE 1344 mode") |
| IEEE C37.118: | Identical to IEEE 1344, but with UTC offset +/- sign bit reversed |
| NASA 36: | 100 pps, AM sine wave signal, 1 kHz carrier frequency, resolution: 10 ms (DCLS), 1 ms (modulated carrier) BCD time of year: 30 bits - seconds, minutes, hours, and days |

12.4 Description of Programmable Pulse Signal Types

If your Meinberg system has programmable signal and pulse outputs, then depending on the system, more or less of the listed signals will be available. These can be configured separately for each signal output.

Idle

Selecting "Idle" enables that specific output to be disabled.

Timer

In "Timer" mode, the output simulates a timer with a fixed daily schedule. It is possible to configure three switch-on and three switch-off times for each day and each output. In order to set a timer, both the switch-on time ("ON") and the corresponding switch-off time ("OFF") must be set. If the switch-on is later than the switch-off time, the switching scheduler will interpret this to mean that the switch-off time is on the next day, which will keep the signal enabled through midnight.

Thus, if a program was set with a switch-on time of 23:45:00 and a switch-off time of 0:30:00, this would cause the output (e.g., PP 1 Out) to be enabled on day n at 11:45 p.m., and then to be disabled on day $n+1$ at 12:30 a.m. If any of these three programs are to be left disabled, simply enter the same times into the ON and OFF fields. The "Signal" selector specifies the active state for the timer periods. Selecting "Normal" will put the output in a low state outside of switch-on periods and in a high state during switch-on periods ("active high"). Conversely, selecting "Inverted" will place the output in a high state outside of switch-on periods and in a low state during switch-on periods ("active low").

Single Shot

"Single Shot" mode generates a single pulse of defined length once per day. The time of day when the pulse is to be generated can be set via the "Time" value. The value "Length" allows the pulse length to be set in 10 msec increments and may be any value in the range of 10 ms to 10 sec.

Cyclic Pulse

"Cyclic Pulse" mode is used to generate cyclically repeating pulses. The time between two pulses is defined, and this value must always be provided in hours, minutes, and seconds. It is important to note that the pulse train is always synchronized with 0:00.00 local time, so that the first pulse on any given day will always be output at midnight, and is repeated at the specified cycle interval henceforth. Thus, if a cycle duration of 2 seconds is specified, this will result in pulses being triggered at 0:00.00, 0:00.02, 0:00.04 and so on. While it is possible to set any cycle time between 0 and 24 hours, these repetitions are usually only useful if the time between pulses is always the same. For example, if a cycle time of 1:45.00 is set, this will output pulses at intervals of 6300 seconds. However, between the last pulse of any given day and the pulse at midnight on the following day, there will be an interval of just 4500 seconds.

Pulses Per Second, Per Min, Per Hour

These modes generate pulses of defined length once per second, once per minute, or once per hour. The configuration options for all three modes are the same. The value "Pulse Length" specifies the length of the pulse and can be between 10 msec and 10 sec.

DCF77 Marks

In "DCF77 Marks" mode the selected output simulates the time string transmitted by the German DCF77 time code transmitter. The pulses output are the 100 ms and 200 ms pulses (logical 0/1) typical for the DCF77 code. The absence of the 59-second mark is used to signal that the next minute will begin with the following second mark.

The 'DCF Suspend After'/'Timeout' field can be used to enter how many minutes the system should wait while in free-run mode before DCF77 simulation is suspended. Entering 0 here will disable the timeout function, so that the DCF77 simulation will continue running perpetually until manually disabled.

Sync Mode

There are three different modes available for outputting the synchronization state of the clock.

Position OK

The "Position OK" mode outputs a signal through the output whenever the GPS receiver is receiving enough satellites to determine its position.

Time Sync

In "Time Sync" mode, a signal is passed through the output while the clock's internal timebase is synchronized to the GPS time.

All Sync

The "All Sync" mode requires both of the above states to be true—sufficient satellites for positioning and synchronization of internal timebase to satellite system for a signal to be passed through the output.

DCLS Time Code

DC level shift time code. The time code output here is configured using the "IRIG Settings" tab in the LANTIME OS Web Interface or the "Outputs Settings" section of Meinberg Device Manager.

10 MHz Frequency

This mode is used to output a fixed frequency of 10 MHz, using a PPS signal as an absolute phase reference (i.e., the falling edge of the 10 MHz signal is synchronized with the rising edge of the PPS signal).

DCF77-like M59

A 500 ms pulse is sent at the 59-second mark.

The 'DCF Suspend After'/'Timeout' field can be used to enter how many minutes the system should wait while in free-run mode before DCF77 simulation is suspended. Entering 0 here will disable the timeout function, so that the DCF77 simulation will continue running perpetually until manually disabled.

Synth. Frequency

This mode is used to output a custom frequency, which is also defined using the "Synthesizer" tab in the LANTIME OS Web Interface or the "Outputs Settings" section of Meinberg Device Manager.

PTTI 1PPS

This mode is used to pass a PPS signal of 20 microseconds length through the output.

1 MHz Frequency

This mode is used to output a fixed frequency of 1 MHz, using a PPS signal as an absolute phase reference (i.e., the falling edge of the 10 MHz signal is synchronized with the rising edge of the PPS signal).

5 MHz Frequency

This mode is used to output a fixed frequency of 5 MHz, using a PPS signal as an absolute phase reference (i.e., the falling edge of the 10 MHz signal is synchronized with the rising edge of the PPS signal).

12.5 SyncMon Formats

SyncMon format for LANTIME firmware usage:

```
SyncMon 172.27.100.32 M3000_100_57_NTP_LAN0_test 58154 34813 2018-02-05T09:
40: 13 + 00: 00 0.000000494 0.000041453 0.000073266 1 R -0.000011100
0.000041453
```

Key-Value-Pairs

The Format with Key-Value-Pairs can be accessed directly from a SPLUNK database server and has the following format:

```
isoTime          = 2018-02-05T09: 40: 13 + 00: 00
syncMonName      = SyncMon
optInterfacelp  = 172.27.100.32
utcTime          = 1517823613
node             = M3000_100_57_NTP_LAN0_test
offset1          = 0.000000494
offset2          = 0.000041453
pathDelay        = 0.000073266
status           = Stratum: 1 / [10]
offset1Min       = -0.000011100
offset1Max       = 0.000041453
type             = NTP / SW / CPU
```

JSON

The JSON format can be processed directly by most databases and has the following format:

```
{
  "isoTime":      "2018-02-05T09: 40: 13 + 00: 00",
  "syncMonName": "SyncMon",
  "optInterfacelp": "172.27.100.32",
  "utcTime":      1517823613,
  "node":         "M3000_100_57_NTP_LAN0_test",
  "offset1":      0.000000494,
  "offset2":      0.000041453,
  "pathDelay":    0.000073266,
  "status":       "stratum 1 / [10]",
  "offset1Min":   - 0.000011100,
  "offset1Max":   0.000041453,
  "type":         "NTP / SW / CPU"
}
```

12.6 Third party software

The LANTIME network timeserver is running a number of software products created and/or maintained by open source projects. A lot of people contributed to this and we explicitly want to thank everyone involved for her/his great work.

The used open source software comes with its own license which we want to mention below. If one of the licenses for a third party software product is violated, we will as soon as possible apply any changes needed in order to conform with the corresponding license after we acknowledged about that violation.

If a license for one of the software products states that we have to provide you with a copy of the source code or other material, we will gladly send it to you on data media via normal post or by e-mail upon request. Alternatively we can provide you with a link to a download location in the internet, allowing you to download the most actual version. Please note that we have to charge you for any incurred expenses if you choose to receive the source code on data media.

12.6.1 Operating System GNU/Linux

The distribution of the GNU/Linux operating system is covered by the GNU General Public License (GPL), which we included below.

More information about GNU/Linux can be found on the GNU website
www.gnu.org

and on the website of GNU/Linux
www.linux.org

12.6.2 Samba

The Samba software suite is a collection of programs, which implement the Server Message Block (SMB) protocol for UNIX systems. By using Samba your Lantime is capable of sending Windows popup messages and serves request for network time by clients using the NET TIME command.

The distribution of Samba is covered – like GNU/Linux – by the GNU General Public License, see below.

The website of the Samba project (or a mirror) can be reached at
www.samba.org

12.6.3 Network Time Protocol Version 4 (NTP)

The NTP project, lead by David L. Mills, can be reached in the internet at www.ntp.org. There you will find a wealthy collection of documentation and information covering all aspects of the application of NTP for time synchronization purposes. The distribution and usage of the NTP software is allowed, as long as the following notice is included in our documentation:

```
*****
*
* Copyright (c) David L. Mills 1992-2004
*
* Permission to use, copy, modify, and distribute this software
* and its documentation for any purpose and without fee is hereby
* granted, provided that the above copyright notice appears in all
* copies and that both the copyright notice and this permission
* notice appear in supporting documentation, and that the name
* University of Delaware not be used in advertising or publicity
* pertaining to distribution of the software without specific,
* written prior permission. The University of Delaware makes no
* representations about the suitability this software for any
* purpose. It is provided "as is" without express or implied
* warranty.
*
*****
```

12.6.4 lighttpd

For our web based configuration tool (HTTP and HTTPS) we use Lighttpd. Lighttpd is a free web server, with all the essential functions of a web server. Lighttpd has been developed by the german Software Developer Jan Kneschke.

The use of this software is covered by the following license:

Copyright (c) 2004, Jan Kneschke, incremental
All rights reserved.

Redistribution and use in source and binary forms, with or without modification, are permitted provided that the following conditions are met:

- Redistributions of source code must retain the above copyright notice, this list of conditions and the following disclaimer.
- Redistributions in binary form must reproduce the above copyright notice, this list of conditions and the following disclaimer in the documentation and/or other materials provided with the distribution.
- Neither the name of the 'incremental' nor the names of its contributors may be used to endorse or promote products derived from this software without specific prior written permission.

THIS SOFTWARE IS PROVIDED BY THE COPYRIGHT HOLDERS AND CONTRIBUTORS "AS IS" AND ANY EXPRESS OR IMPLIED WARRANTIES, INCLUDING, BUT NOT LIMITED TO, THE IMPLIED WARRANTIES OF MERCHANTABILITY AND FITNESS FOR A PARTICULAR PURPOSE ARE DISCLAIMED. IN NO EVENT SHALL THE COPYRIGHT OWNER OR CONTRIBUTORS BE LIABLE FOR ANY DIRECT, INDIRECT, INCIDENTAL, SPECIAL, EXEMPLARY, OR CONSEQUENTIAL DAMAGES (INCLUDING, BUT NOT LIMITED TO, PROCUREMENT OF SUBSTITUTE GOODS OR SERVICES; LOSS OF USE, DATA, OR PROFITS; OR BUSINESS INTERRUPTION) HOWEVER CAUSED AND ON ANY THEORY OF LIABILITY, WHETHER IN CONTRACT, STRICT LIABILITY, OR TORT (INCLUDING NEGLIGENCE OR OTHERWISE) ARISING IN ANY WAY OUT OF THE USE OF THIS SOFTWARE, EVEN IF ADVISED OF THE POSSIBILITY OF SUCH DAMAGE.

12.6.5 GNU General Public License (GPL)

Version 2, June 1991 - Copyright (C) 1989, 1991

Free Software Foundation, Inc.

675 Mass Ave, Cambridge, MA 02139, USA

Everyone is permitted to copy and distribute verbatim copies of this license document, but changing it is not allowed.

Preamble

The licenses for most software are designed to take away your freedom to share and change it. By contrast, the GNU General Public License is intended to guarantee your freedom to share and change free software—to make sure the software is free for all its users. This General Public License applies to most of the Free Software Foundation's software and to any other program whose authors commit to using it. (Some other Free Software Foundation software is covered by the GNU Library General Public License instead.) You can apply it to your programs, too.

When we speak of free software, we are referring to freedom, not price. Our General Public Licenses are designed to make sure that you have the freedom to distribute copies of free software (and charge for this service if you wish), that you receive source code or can get it if you want it, that you can change the software or use pieces of it in new free programs; and that you know you can do these things.

To protect your rights, we need to make restrictions that forbid anyone to deny you these rights or to ask you to surrender the rights. These restrictions translate to certain responsibilities for you if you distribute copies of the software, or if you modify it.

For example, if you distribute copies of such a program, whether gratis or for a fee, you must give the recipients all the rights that you have. You must make sure that they, too, receive or can get the source code. And you must show them these terms so they know their rights.

We protect your rights with two steps: (1) copyright the software, and (2) offer you this license which gives you legal permission to copy, distribute and/or modify the software.

Also, for each author's protection and ours, we want to make certain that everyone understands that there is no warranty for this free software. If the software is modified by someone else and passed on, we want its recipients to know that what they have is not the original, so that any problems introduced by others will not reflect on the original authors' reputations.

Finally, any free program is threatened constantly by software patents. We wish to avoid the danger that redistributors of a free program will individually obtain patent licenses, in effect making the program proprietary. To prevent this, we have made it clear that any patent must be licensed for everyone's free use or not licensed at all.

The precise terms and conditions for copying, distribution and modification follow.

GNU GENERAL PUBLIC LICENSE TERMS AND CONDITIONS FOR COPYING, DISTRIBUTION AND MODIFICATION

0. This License applies to any program or other work which contains a notice placed by the copyright holder saying it may be distributed under the terms of this General Public License. The "Program", below, refers to any such program or work, and a "work based on the Program" means either the Program or any derivative work under copyright law: that is to say, a work containing the Program or a portion of it, either verbatim or with modifications and/or translated into another language. (Hereinafter, translation is included without limitation in the term "modification".) Each licensee is addressed as "you".

Activities other than copying, distribution and modification are not covered by this License; they are outside its scope. The act of running the Program is not restricted, and the output from the Program is covered only if its contents constitute a work based on the Program (independent of having been made by running the Program).

Whether that is true depends on what the Program does.

1. You may copy and distribute verbatim copies of the Program's source code as you receive it, in any medium, provided that you conspicuously and appropriately publish on each copy an appropriate copyright notice and disclaimer of warranty; keep intact all the notices that refer to this License and to the absence of any warranty; and give any other recipients of the Program a copy of this License along with the Program.

You may charge a fee for the physical act of transferring a copy, and you may at your option offer warranty protection in exchange for a fee.

2. You may modify your copy or copies of the Program or any portion of it, thus forming a work based on the Program, and copy and distribute such modifications or work under the terms of Section 1 above, provided that you also meet all of these conditions:

a) You must cause the modified files to carry prominent notices stating that you changed the files and the date of any change.

b) You must cause any work that you distribute or publish, that in whole or in part contains or is derived from the Program or any part thereof, to be licensed as a whole at no charge to all third parties under the terms of this License.

c) If the modified program normally reads commands interactively when run, you must cause it, when started running for such interactive use in the most ordinary way, to print or display an announcement including an appropriate copyright notice and a notice that there is no warranty (or else, saying that you provide a warranty) and that users may redistribute the program under these conditions, and telling the user how to view a copy of this License. (Exception: if the Program itself is interactive but does not normally print such an announcement, your work based on the Program is not required to print an announcement.)

These requirements apply to the modified work as a whole. If identifiable sections of that work are not derived from the Program, and can be reasonably considered independent and separate works in themselves, then this License, and its terms, do not apply to those sections when you distribute them as separate works. But when you distribute the same sections as part of a whole which is a work based on the Program, the distribution of the whole must be on the terms of this License, whose permissions for other licensees extend to the entire whole, and thus to each and every part regardless of who wrote it.

Thus, it is not the intent of this section to claim rights or contest your rights to work written entirely by you; rather, the intent is to exercise the right to control the distribution of derivative or collective works based on the Program.

In addition, mere aggregation of another work not based on the Program with the Program (or with a work based on the Program) on a volume of a storage or distribution medium does not bring the other work under the scope of this License.

3. You may copy and distribute the Program (or a work based on it, under Section 2) in object code or executable form under the terms of Sections 1 and 2 above provided that you also do one of the following:

a) Accompany it with the complete corresponding machine-readable source code, which must be distributed under the terms of Sections 1 and 2 above on a medium customarily used for software interchange; or,

b) Accompany it with a written offer, valid for at least three years, to give any third party, for a charge no more than your cost of physically performing source distribution, a complete machine-readable copy of the corresponding source code, to be distributed under the terms of Sections 1 and 2 above on a medium customarily used for software interchange; or,

c) Accompany it with the information you received as to the offer to distribute corresponding source code. (This alternative is allowed only for noncommercial distribution and only if you received the program in object code or executable form with such an offer, in accord with Subsection b above.)

The source code for a work means the preferred form of the work for making modifications to it. For an executable work, complete source code means all the source code for all modules it contains, plus any associated interface definition files, plus the scripts used to control compilation and installation of the executable. However, as a special exception, the source code distributed need not include anything that is normally distributed (in either

source or binary form) with the major components (compiler, kernel, and so on) of the operating system on which the executable runs, unless that component itself accompanies the executable.

If distribution of executable or object code is made by offering access to copy from a designated place, then offering equivalent access to copy the source code from the same place counts as distribution of the source code, even though third parties are not compelled to copy the source along with the object code.

4. You may not copy, modify, sublicense, or distribute the Program except as expressly provided under this License. Any attempt otherwise to copy, modify, sublicense or distribute the Program is void, and will automatically terminate your rights under this License. However, parties who have received copies, or rights, from you under this License will not have their licenses terminated so long as such parties remain in full compliance.

5. You are not required to accept this License, since you have not signed it. However, nothing else grants you permission to modify or distribute the Program or its derivative works. These actions are prohibited by law if you do not accept this License. Therefore, by modifying or distributing the Program (or any work based on the Program), you indicate your acceptance of this License to do so, and all its terms and conditions for copying, distributing or modifying the Program or works based on it.

6. Each time you redistribute the Program (or any work based on the Program), the recipient automatically receives a license from the original licensor to copy, distribute or modify the Program subject to these terms and conditions. You may not impose any further restrictions on the recipients' exercise of the rights granted herein. You are not responsible for enforcing compliance by third parties to this License.

7. If, as a consequence of a court judgment or allegation of patent infringement or for any other reason (not limited to patent issues), conditions are imposed on you (whether by court order, agreement or otherwise) that contradict the conditions of this License, they do not excuse you from the conditions of this License. If you cannot distribute so as to satisfy simultaneously your obligations under this License and any other pertinent obligations, then as a consequence you may not distribute the Program at all. For example, if a patent license would not permit royalty-free redistribution of the Program by all those who receive copies directly or indirectly through you, then the only way you could satisfy both it and this License would be to refrain entirely from distribution of the Program.

If any portion of this section is held invalid or unenforceable under any particular circumstance, the balance of the section is intended to apply and the section as a whole is intended to apply in other circumstances.

It is not the purpose of this section to induce you to infringe any patents or other property right claims or to contest validity of any such claims; this section has the sole purpose of protecting the integrity of the free software distribution system, which is implemented by public license practices. Many people have made generous contributions to the wide range of software distributed through that system in reliance on consistent application of that system; it is up to the author/donor to decide if he or she is willing to distribute software through any other system and a licensee cannot impose that choice.

This section is intended to make thoroughly clear what is believed to be a consequence of the rest of this License.

8. If the distribution and/or use of the Program is restricted in certain countries either by patents or by copyrighted interfaces, the original copyright holder who places the Program under this License may add an explicit geographical distribution limitation excluding those countries, so that distribution is permitted only in or among countries not thus excluded. In such case, this License incorporates the limitation as if written in the body of this License.

9. The Free Software Foundation may publish revised and/or new versions of the General Public License from time to time. Such new versions will be similar in spirit to the present version, but may differ in detail to address new problems or concerns.

Each version is given a distinguishing version number. If the Program specifies a version number of this License which applies to it and "any later version", you have the option of following the terms and conditions either of that version or of any later version published by the Free Software Foundation. If the Program does not specify a version number of this License, you may choose any version ever published by the Free Software Foundation.

10. If you wish to incorporate parts of the Program into other free programs whose distribution conditions are different, write to the author to ask for permission. For software which is copyrighted by the Free Software Foundation, write to the Free Software Foundation; we sometimes make exceptions for this. Our decision will be guided by the two goals of preserving the free status of all derivatives of our free software and of promoting the sharing and reuse of software generally.

NO WARRANTY

11. BECAUSE THE PROGRAM IS LICENSED FREE OF CHARGE, THERE IS NO WARRANTY FOR THE PROGRAM, TO THE EXTENT PERMITTED BY APPLICABLE LAW. EXCEPT WHEN OTHERWISE STATED IN WRITING THE COPYRIGHT HOLDERS AND/OR OTHER PARTIES PROVIDE THE PROGRAM "AS IS" WITHOUT WARRANTY OF ANY KIND, EITHER EXPRESSED OR IMPLIED, INCLUDING, BUT NOT LIMITED TO, THE IMPLIED WARRANTIES OF MERCHANTABILITY AND FITNESS FOR A PARTICULAR PURPOSE. THE ENTIRE RISK AS TO THE QUALITY AND PERFORMANCE OF THE PROGRAM IS WITH YOU. SHOULD THE PROGRAM PROVE DEFECTIVE, YOU ASSUME THE COST OF ALL NECESSARY SERVICING, REPAIR OR CORRECTION.

12. IN NO EVENT UNLESS REQUIRED BY APPLICABLE LAW OR AGREED TO IN WRITING WILL ANY COPYRIGHT HOLDER, OR ANY OTHER PARTY WHO MAY MODIFY AND/OR REDISTRIBUTE THE PROGRAM AS PERMITTED ABOVE, BE LIABLE TO YOU FOR DAMAGES, INCLUDING ANY GENERAL, SPECIAL, INCIDENTAL OR CONSEQUENTIAL DAMAGES ARISING OUT OF THE USE OR INABILITY TO USE THE PROGRAM (INCLUDING BUT NOT LIMITED TO LOSS OF DATA OR DATA BEING RENDERED INACCURATE OR LOSSES SUSTAINED BY YOU OR THIRD PARTIES OR A FAILURE OF THE PROGRAM TO OPERATE WITH ANY OTHER PROGRAMS), EVEN IF SUCH HOLDER OR OTHER PARTY HAS BEEN ADVISED OF THE POSSIBILITY OF SUCH DAMAGES.

END OF TERMS AND CONDITIONS

12.7 List of Literature

- [Mills88] Mills, D. L., "Network Time Protocol (Version 1) - specification and implementation", DARPA Networking Group Report RFC-1059, University of Delaware, July 1988
- [Mills89] Mills, D. L., "Network Time Protocol (Version 2) - specification and implementation", DARPA Networking Group Report RFC-1119, University of Delaware, September 1989
- [Mills90] Mills, D. L., "Network Time Protocol (Version 3) - specification, implementation and analysis", Electrical Engineering Department Report 90-6-1, University of Delaware, June 1989
- Kardel, Frank, "Gesetzliche Zeit in Rechnernetzen", Funkuhren, Zeitsignale und Normalfrequenzen, Hrsg. W. Hilberg, Verlag Sprache und Technik, Groß-Bieberau 1993
- Kardel, Frank, "Verteilte Zeiten", ix Multiuser-Multitasking-Magazin, Heft 2/93, Verlag Heinz Heise, Hannover 1993